

MOUNTING AND OPERATING INSTRUCTIONS



EB 8384-6 EN

Translation of original instructions



Old design



New design

HART
COMMUNICATION PROTOCOL

Series 3730
Type 3730-6 Electropneumatic Positioner
with pressure sensors, communication: HART®

Firmware version 1.1x

CE **EAC** **Ex**
certified



Edition October 2020

Note on these mounting and operating instructions

These mounting and operating instructions assist you in mounting and operating the device safely. The instructions are binding for handling SAMSON devices. The images shown in these instructions are for illustration purposes only. The actual product may vary.

- For the safe and proper use of these instructions, read them carefully and keep them for later reference.
- If you have any questions about these instructions, contact SAMSON's After-sales Service (aftersaleservice@samsongroup.com).



Documents relating to the device, such as the mounting and operating instructions, are available on our website at www.samsongroup.com > **Downloads > Documentation.**

These mounting and operating instructions are valid for firmware versions 1.10 to 1.19. A detailed list of revisions is included in the 'Markings on the device' chapter.

Definition of signal words

DANGER

Hazardous situations which, if not avoided, will result in death or serious injury

WARNING

Hazardous situations which, if not avoided, could result in death or serious injury

NOTICE

Property damage message or malfunction

Note

Additional information

Tip

Recommended action

1	Safety instructions and measures	1-1
1.1	Notes on possible severe personal injury	1-4
1.2	Notes on possible personal injury	1-4
1.3	Notes on possible property damage	1-5
1.4	Special instructions concerning explosion protection	1-6
2	Markings on the device	2-1
2.1	Nameplate	2-1
2.2	Article code	2-2
2.3	Firmware versions	2-4
3	Design and principle of operation	3-1
3.1	Additional equipment	3-2
3.2	Attachment versions	3-3
3.3	Communication	3-4
3.4	Configuration using the TROVIS-VIEW software	3-4
3.5	Technical data	3-5
3.6	Dimensions in mm	3-11
3.6.1	Fixing levels according to VDI/VDE 3845 (September 2010)	3-15
4	Shipment and on-site transport	4-1
4.1	Accepting the delivered goods	4-1
4.2	Removing the packaging from the positioner	4-1
4.3	Transporting the positioner	4-1
4.4	Storing the positioner	4-1
5	Installation	5-1
5.1	Installation conditions	5-1
5.2	Preparation for installation	5-2
5.3	Adjusting the lever and pin position	5-2
5.3.1	Travel tables	5-4
5.4	Positioner attachment	5-6
5.4.1	Direct attachment	5-6
5.4.2	Attachment according to IEC 60534-6	5-10
5.4.3	Attachment according to VDI/VDE 3847-1	5-12
5.4.4	Attachment according to VDI/VDE 3847-2	5-16
5.4.5	Attachment to Type 3510 Micro-flow Valve	5-24
5.4.6	Attachment to rotary actuators	5-24
5.4.7	Reversing amplifier for double-acting actuators	5-30
5.5	Mounting the external position sensor	5-30

Contents

5.5.1	Mounting the position sensor with direct attachment.....	5-31
5.5.2	Mounting the position sensor with attachment according to IEC 60534-6 (NAMUR).....	5-32
5.5.3	Mounting the position sensor on a Type 3510 Micro-flow Valve.....	5-34
5.5.4	Mounting on rotary actuators.....	5-35
5.6	Mounting the leakage sensor	5-36
5.7	Retrofitting inductive limit switch	5-37
5.8	Mounting positioners with stainless steel housings.....	5-38
5.9	Air purging function for single-acting actuators	5-38
5.10	Pneumatic connection.....	5-40
5.10.1	Signal pressure connection	5-41
5.10.2	Signal pressure reading.....	5-41
5.10.3	Supply pressure	5-41
5.10.4	Signal pressure (output).....	5-42
5.11	Electrical connection.....	5-42
5.11.1	Switching amplifier according to EN 60947-5-6	5-44
5.11.2	Establishing communication	5-44
5.12	Mounting accessories	5-46
6	Operation	6-1
6.1	Serial interface	6-2
6.2	HART® communication	6-4
6.2.1	Dynamic HART® variables	6-4
7	Start-up and configuration.....	7-1
7.1	Determining the fail-safe position	7-2
7.2	Adjusting the volume restriction Q.....	7-3
7.3	Limiting the signal pressure.....	7-3
7.4	Checking the operating range of the positioner	7-4
7.5	Initializing the positioner	7-5
7.5.1	MAX – Initialization based on maximum range.....	7-8
7.5.2	NOM – Initialization based on nominal range	7-9
7.5.3	MAN – Initialization based on a manually selected OPEN position	7-10
7.5.4	MAN2 – Initialization based on manually selected end positions	7-12
7.5.5	SUB – Substitute calibration	7-13
7.5.6	Tuning the KP input filter	7-17
7.6	Setting other parameters.....	7-18
7.7	Adjusting inductive limit switch.....	7-19

8	Operation	8-1
8.1	Adapting the display direction	8-1
8.2	Changing the operating modes	8-2
8.2.1	Closed-loop operation (automatic mode)	8-2
8.2.2	Manual mode	8-2
8.2.3	Fail-safe position (SAFE)	8-3
8.3	Performing zero calibration	8-4
8.4	Resetting the positioner	8-5
9	Malfunction	9-1
9.1	Troubleshooting	9-2
9.2	Emergency action	9-4
10	Servicing	10-1
10.1	Cleaning the cover window	10-2
10.2	Cleaning the filters	10-2
10.3	Maintenance of the supply air pressure reducing stations	10-2
10.4	Firmware updates	10-2
10.5	Periodic inspection and testing of the positioner	10-2
11	Decommissioning	11-1
12	Removal	12-1
13	Repairs	13-1
13.1	Servicing explosion-protected devices	13-1
13.2	Returning devices to SAMSON	13-1
14	Disposal	14-1
15	Certificates	15-1
16	Appendix A (configuration instructions)	16-1
16.1	Parameters and functions	16-1
16.1.1	Error codes	16-12
16.2	Selecting the characteristic	16-19
17	Appendix B	17-1
17.1	Accessories	17-1
17.2	After-sales service	17-7

1 Safety instructions and measures

Intended use

SAMSON's Type 3730-6 Positioner is mounted on pneumatic control valves and used to assign the valve position to the control signal. The device is designed to operate under exactly defined conditions (e.g. operating pressure, temperature). Therefore, operators must ensure that the positioner is only used in applications where the operating conditions correspond to the technical data. In case operators intend to use the positioner in other applications or conditions than specified, contact SAMSON.

SAMSON does not assume any liability for damage resulting from the failure to use the device for its intended purpose or for damage caused by external forces or any other external factors.

➔ Refer to the technical data for limits and fields of application as well as possible uses.

Reasonably foreseeable misuse

The Type 3730-6 Positioner is **not** suitable for the following applications:

- Use outside the limits defined during sizing and by the technical data

Furthermore, the following activities do not comply with the intended use:

- Use of non-original spare parts

- Performing maintenance activities not described in these instructions

Qualifications of operating personnel

The positioner must be mounted, started up or operated only by trained and experienced personnel familiar with the product. According to these mounting and operating instructions, trained personnel refers to individuals who are able to judge the work they are assigned to and recognize possible hazards due to their specialized training, their knowledge and experience as well as their knowledge of the applicable standards.

Explosion-protected versions of this device must be operated only by personnel who has undergone special training or instructions or who is authorized to work on explosion-protected devices in hazardous areas.

Safety instructions and measures

Personal protective equipment

No personal protective equipment is required for the direct handling of the positioner. Work on the control valve may be necessary when mounting or removing the device.

- Observe the requirements for personal protective equipment specified in the valve documentation.
- Check with the plant operator for details on further protective equipment.

Revisions and other modifications

Revisions, conversions or other modifications of the product are not authorized by SAMSON. They are performed at the user's own risk and may lead to safety hazards, for example. Furthermore, the product may no longer meet the requirements for its intended use.

Safety features

Upon failure of the air supply or electric signal, the positioner vents the actuator, causing the valve to move to the fail-safe position determined by the actuator.

Warning against residual hazards

The positioner has direct influence on the control valve. Any hazards that could be caused in the valve by the process medium, the signal pressure or by moving parts are to be prevented by taking appropriate precautions. Plant operators and operating personnel must observe all hazard statements, warning and caution notes in these mounting and operating instructions, especially for installation, start-up and service work.

If inadmissible motions or forces are produced in the pneumatic actuator as a result of the supply pressure, it must be restricted using a suitable supply pressure reducing station.

Responsibilities of the operator

Operators are responsible for proper use and compliance with the safety regulations. Operators are obliged to provide these mounting and operating instructions to the operating personnel and to instruct them in proper operation. Furthermore, operators must ensure that operating personnel or third parties are not exposed to any danger.

Responsibilities of operating personnel

Operating personnel must read and understand these mounting and operating instructions as well as the specified hazard statements, warning and caution notes. Furthermore, the operating personnel must be familiar with the applicable health, safety and accident prevention regulations and comply with them.

Referenced standards, directives and regulations

Devices with a CE marking fulfill the following requirements of the Directives:

- Type 3730-6: 2014/30/EU, 2011/65/EU
- Type 3730-6-110, -210, -510, -810: 2014/30/EU, 2014/34/EU, 2011/65/EU

Devices with an EAC marking fulfill the following requirements of the Regulations:

- Type 3730-6: TR CU 020/2011
- Type 3730-6-113, -213, -813: TR CU 012/2011 with the applicable GOST standards:
 - ГOCT 31610.11-2014 (IEC 60079-11:2011)
 - ГOCT 31610.15-2012/МЭK 60079-15:2005
 - ГOCT 31610.0-2014 (IEC 60079-0:2011)
 - ГOCT IEC 60079-1-2011
 - ГOCT IEC 60079-31-2010

See the 'Certificates' chapter for the declarations of conformity and EAC certificates.

Referenced documentation

The following documents apply in addition to these mounting and operating instructions:

- Operating instructions for valve diagnostics: ► EB 8389
- Safety manual: ► SH 8384-6
- The mounting and operating instructions of the components on which the positioner is mounted (valve, actuator, valve accessories etc.).

1.1 Notes on possible severe personal injury

DANGER

Risk of fatal injury due to the ignition of an explosive atmosphere.

Incorrect installation, operation or maintenance of the positioner in potentially explosive atmospheres may lead to ignition of the atmosphere and ultimately to death.

- The following regulations apply to installation in hazardous areas: EN 60079-14 (VDE 0165, Part 1).
- Installation, operation or maintenance of the positioner must only be performed by personnel who has undergone special training or instructions or who is authorized to work on explosion-protected devices in hazardous areas.
- Read the special instructions concerning explosion protection (see Chapter 1.4).

1.2 Notes on possible personal injury

WARNING

Crush hazard arising from moving parts on the valve.

Control valves contain moving parts (actuator and plug stem), which can injure hands or fingers if inserted into the valve.

- Do not touch any moving valve parts while the control valve is in operation.
- Before performing any mounting or installation work on the positioner, put the control valve out of operation by disconnecting and locking the supply air and control signal.
- Do not impede the movement of the actuator and plug stem by inserting objects into the yoke.

Incorrect electrical connection will render the explosion protection unsafe.

- Adhere to the terminal assignment.
- Do not undo the enameled screws in or on the housing.

Intrinsic safety rendered ineffective in intrinsically safe devices.

Every time the positioner is operated, even not within the plant (e.g. during maintenance, calibration and work on equipment), it must be ensured that the conditions for intrinsically safe circuits are observed.

- Only connect intrinsically safe devices intended for use in intrinsically safe circuits to certified intrinsically safe input-connected units.
- Do not place intrinsically safe devices back into operation that were connected to intrinsically safe input-connected units without certification.
- Do not exceed the maximum permissible electric values specified in the EC type examination certificates when interconnecting intrinsically safe electrical equipment (U_i or U_0 , I_i or I_0 , P_i or P_0 , C_i or C_0 and L_i or L_0).

1.3 Notes on possible property damage

NOTICE

Risk of damage to the positioner due to incorrect mounting position.

- Do not mount the positioner with the back of the device facing upward.
- Do not seal or restrict the vent opening when the device is installed on site.

An incorrect electric signal will damage the positioner.

For the positioner to function properly, a current source and compliance with the prescribed terminal assignment are necessary.

- Only use a current source and never a voltage source.
- Connect the electrical wiring to the positioner according to the prescribed terminal assignment.

Malfunction due to initialization not yet completed.

The initialization causes the positioner to be calibrated to adapt it to the mounting situation. After initialization is completed, the positioner is ready for use.

- Initialize the positioner on first start-up.
- Re-initialize positioner after changing the mounting position.

Risk of positioner damage due to incorrect grounding of the electric welding equipment.

→ Do not ground electric welding equipment near to the positioner.

Incorrect cleaning will damage the window.

The window is made of Makrolon® and will be damaged when cleaned with abrasive cleaning agents or agents containing solvents.

→ Do not rub the window dry.

→ Do not use any cleaning agents containing chlorine or alcohol or abrasive cleaning agents.

→ Use a non-abrasive, soft cloth for cleaning.

1.4 Special instructions concerning explosion protection

Explosive dust atmospheres of zone 21 or zone 22

- The following applies to type of protection Ex i in combustible dust atmospheres:
 - If intrinsic safety is impaired by the influence of dust, an enclosure complying with Clause 6.1.3 of EN 60079-11 with at least degree of protection IP 5X must be used. The requirements according to Clause 6.1.3 apply to the cable entries and conduit systems accordingly.
 - The degree of ingress protection is verified by a test according to IEC 60529 and EN 60079-0 (e.g. performed by VDE).
- For use in the presence of combustible dust in compliance with type of protection Ex tb IIIC (protection by enclosure), observe clause 5.6.3 of EN 60079-14.

Equipment for use in zone 2/zone 22:

- In equipment operated according to type of protection Ex nA (non-sparking equipment) according to EN 60079-15, circuits may be connected, interrupted or switched while energized only during installation, maintenance or repair.
- Observe the special conditions of use mentioned in the statement of conformity for the rated values and the installation of the series-connected fuse for interconnection of Ex nA circuits.

- Positioners with type of protection Ex nA or Ex tc can be used with a cover with or without window.
- The Types 3730-61, 3730-65 and 3730-68 Positioners are 100 % identical in design, except for the marking and the housing cover.
- For type of protection Ex nA, connect the VCC connection in the program interface adapter in series with a fuse according to IEC 60127, 250 V F or T with a fuse rating of max. $I_N \leq 40$ mA.
- Connect the signal current circuit in series with a fuse according to IEC 60127-2/VI, 250 V T with a fuse rating of $I_N \leq 63$ mA.
- Connect the transmitter current circuit in series with a fuse according to IEC 60127-2/VI, 250 V T with a fuse rating of $I_N \leq 40$ mA.
- Install the fuses outside the hazardous area.

Servicing explosion-protected devices

- Observe the following for servicing equipment in a section relevant for explosion protection:
 - It must not be put back into operation until a qualified inspector has assessed the equipment according to explosion protection requirements, has issued an inspection certificate or given the device a mark of conformity. Inspection by a qualified inspector is not required if the manufacturer performed a routine test on the device before putting it back into operation. Document the passing of the routine test by attaching a mark of conformity to the device.
 - Replace explosion-protected components only with original, routine-tested components by the manufacturer.
 - Devices that have already been used outside hazardous areas and are intended for future use inside hazardous areas must comply with the safety requirements placed on serviced devices. They must be subjected to testing according to the specifications in EN 60079-19.
 - EN 60079-19 applies to servicing explosion-protected devices.
 - Use the protective cable designed by SAMSON when interconnecting non-intrinsically safe set point calibrators with intrinsically safe equipment for repair, calibration etc. to ensure that components relevant to explosion protection are not damaged.

2 Markings on the device

2.1 Nameplate



The nameplates shown were up to date at the time of publication of this document. The nameplates on the device may differ from the ones shown.

Version without explosion protection

SAMSON 3730 - 6 13
Digital HART® Positioner
 Supply max. 1
 Input 3
 Shutdown at 4
 5 Fault indicator*
 Limit switches, software*
 Limit switch, inductive
 Solenoid valve
 $U_n = 24 \text{ V DC}$
 Forced venting function
 Position indicator
 Output 4...20 mA
 Leakage detection
 Binary input
 * Conductive: $R_i = 348 \Omega$
 PLC-compatible: $VDC \leq +35V$
 See technical data for ambient temperature
 Diagnostics EXPERTplus
 Firmware 9
 Model 3730 - 6- 12
 Var.-ID 10 Serial no. 11
 SAMSON AG D-60314 Frankfurt Made in Germany

Date
6

Explosion-protected version

SAMSON 3730-6 13
Digital HART® Positioner
 Supply max. 1
 2
 Input 3
 Shutdown at 4
 5 Fault indicator*
 Limit switches, software*
 Limit switch, inductive*
 Solenoid valve*
 Forced venting function*
 Position indicator*
 Leakage detection* (-40 °C)
 Binary input* 
 * See technical data and explosion-protection certificate for permissible ambient temperature and maximum values for connection to certified intrinsically safe circuits.
 See technical data for ambient temperature and maximum values for connection to certified intrinsically safe circuits.
 Diagnostics EXPERTplus Date 6
 SAM 7 HV 8 SV 9
 Mat. 10 S/N 11
 Model 3730-6-12
 SAMSON AG D-60314 Frankfurt Made in Germany

- 1 Supply pressure
- 2 Explosion protection marking
- 3 Input signal
- 4 Emergency shutdown
- 5 Features: Yes/ No
 - Fault indicator
 - Limit switches, software
 - Limit switch, inductive
 - Solenoid valve
 - Forced venting function
 - Position indicator
 - Leakage detection
 - Binary input
- 6 Year of manufacture
- 7 Code for NAMUR Recommendation NE 53 (internal specification)
- 8 Hardware version
- 9 Software version
- 10 Configuration ID/model number
- 11 Serial number
- 12 Article code
- 13 Conformity

Markings on the device

2.2 Article code

Positioner	Type 3730-6-	x	x	x	x	x	x	x	0	x	x	0	x	0	0
With display and autotune, HART® communication, 4 to 20 mA set point, two software limit contacts, one fault alarm contact															
Explosion protection															
Without		0	0	0											
ATEX	II 2 G Ex ia IIC T6 Gb; II 2 D Ex ia IIIC T80 °C Db	1	1	0											
IECEX	Ex ia IIIC T80 °C Db; Ex ia IIC T6 Gb	1	1	1											
CCC Ex	Ex ia IIC T4...T6 Gb; Ex ia IIIC T80°C Db														
TR CMU 1055	II 2G Ex ia IIC T6 Gb; II 2D Ex ia IIIC T80°C Db	1	1	6											
FM	Intrinsically safe: IS / Class I,II,III / Div. 1 / Gr. ABCDEFG; AEx ia IIC / Class I / Zone 0 Non Incendive: NI / Class I / Div. 2 / Gr. ABCD; S / Class II / Div. 2 / Gr. FG; Enclosure Type 4X	1	3	0											
CSA	Ex ia IIC T4/T5/T6; Class I, Zone 0; Class I, Groups A,B,C,and D; Class II Groups E,F and G; Class III; Type 4 Enclosure	1	3	1											
ATEX	II 2 G Ex d[ia] IIC T6 Gb; II 2 D Ex tb IIIC T80 °C Db	2	1	0											
IECEX	Ex db[ia] IIC T6 Gb; Ex tb IIIC T80 °C Db	2	1	1											
ATEX	II 2 D Ex tb IIIC T80 °C Db	5	1	0											
IECEX	Ex tb IIIC T80°C Db	5	1	1											
CCC Ex	Ex tb IIIC T80°C Db														
TR CMU 1055	II 2D Ex tb IIIC T80°C Db	5	1	6											
ATEX	II 3 G Ex nA ic IIC T6 Gc; II 3 D Ex tc IIIC T80°C Dc IP66	8	1	0											
IECEX	Ex nA IIC T6; Ex nL IIC T6; Ex tD A22 IP66 T80 °C	8	1	1											
TR CMU 1055	II 3G Ex nA IIC T6 Gc; II 3D Ex tc IIIC T80°C Dc	8	1	6											
Option (additional equipment)															
Inductive limit contact															
Without				0											
SJ2-SN (NC contact)				1				0							
Venting function															
Without				0											
Solenoid valve, 24 V DC				1											
Forced venting, 24 V DC				2											
Additional equipment															
Without				0											
Position transmitter								1	0						
Leakage sensor (including cable and fixing screw)								2	0						
Binary input								3	0						

Positioner	Type 3730-6- x x x x x x x 0 x x 0 x 0 0					
External position sensor						
Without	0					
With, including 10 m connecting cable	1		1			
Prepared for connection, without sensor	2					
Function						
Standard (control valves)	0					
Emergency shutdown						
3.8 mA			0			
4.4 mA			1			
Housing material						
Aluminum (standard)				1		
Stainless steel				2		
Special applications						
Without						0
Device compatible with paint						1
Exhaust air port with 1/4-18 NPT thread, back of positioner sealed						2
With additional vent hole and VDI/VDE 3847 adapter						6
With additional vent hole						7

2.3 Firmware versions

Firmware revisions	
Old	New
1.0x	1.10
	A positioner that has not yet been initialized has 'Out of specification' NAMUR status (previously 'Failure'). Default settings of diagnostic parameters revised ► EB 8389-1.
1.10	1.11
	A positioner that has not yet been initialized assumes the 'Out of specification' NAMUR status ('Failure' in version 1.10 and lower). Default values of the dynamic test adapted to the positioner series. Other production-related revisions.
1.11	1.12
	Correction: the valve position is now measured in the fail-safe position. Before correction, 0 or 100 % was issued as a fixed value in the fail-safe position although the valve position may have had another value.

3 Design and principle of operation

→ See Fig. 3-1

The electropneumatic positioner is mounted on pneumatic control valves and used to assign the valve position (controlled variable x) to the control signal (reference variable w). The positioner compares the electric control signal of a control system to the travel or

opening angle of the control valve and issues a signal pressure (output variable y) for the pneumatic actuator.

The positioner consists of a travel sensor system (2) proportional to resistance, an analog i/p converter (6) with a downstream air booster (7) and the electronics with microcontroller (5).

The positioner is fitted with three binary contacts as standard: A fault alarm output indi-

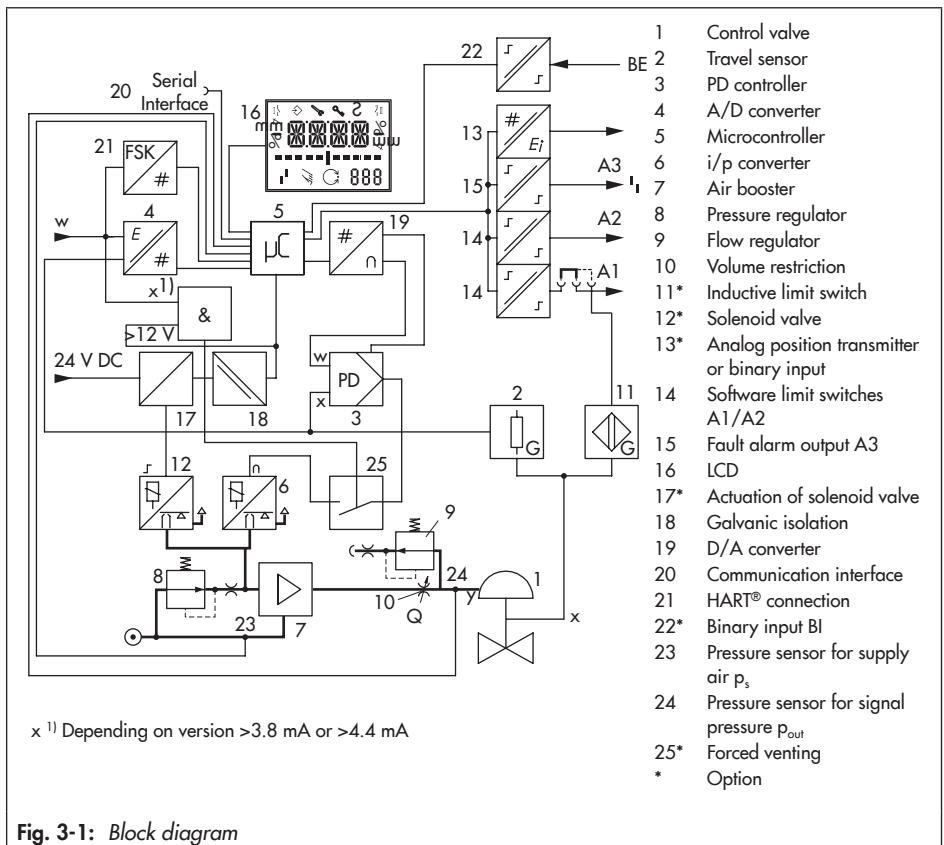

Fig. 3-1: Block diagram

cates a fault to the control room and two configurable software limit switches are used to indicate the end positions of the valve.

The valve position (x) is transmitted as a either an angle of rotation or travel to the pick-up lever and to the travel sensor (2) and supplied to an analog PD controller. An A/D converter (4) transmits the position of the valve to the microcontroller (5). The PD controller (3) compares this actual position to the 4 to 20 mA DC control signal (reference variable) after it has been converted by the A/D converter (4). In case of a set point deviation, the activation of the i/p converter (6) is changed so that the actuator of the control valve (1) is pressurized or vented accordingly over the downstream booster (7). This causes the valve plug to move to the position determined by the reference variable (w).

The supply air is supplied to the booster (7) and the pressure regulator (8). An intermediate flow regulator (9) with fixed settings is used to purge the positioner and, at the same time, guarantees trouble-free operation of the booster. The output signal pressure supplied by the booster can be limited by software. Both pressure sensors (23 and 24) monitor the supply pressure p_s and the signal pressure p_{out} .

The volume restriction Q (10) is used to optimize the positioner.

3.1 Additional equipment

Inductive limit switch

In this version, the rotary shaft of the positioner carries an adjustable tag which actuates the built-in proximity switch. The optional inductive contact (11) is connected to A1, while the remaining software limit switch is connected to A2.

Solenoid valve

If the operating voltage for the solenoid valve (12) falls below 12 V, the supply pressure for the booster is vented to the atmosphere. As a result, the actuator is vented and the control valve moves to the fail-safe position. **In manual mode, the manual set point is reset to 0 %. A different manual set point must entered again.**

Forced venting

If the voltage signal at terminals +81/-82 falls below 12 V, the i/p converter (6) is not activated. The positioner vents the actuator, causing the valve to move to the fail-safe position determined by the actuator, independent of the reference variable.

Analog position transmitter

The position transmitter (13) is a two-wire transmitter and issues the travel sensor signal as a 4 to 20 mA signal processed by the microcontroller. Since this signal is issued independent of the positioner's input signal, the momentary travel/angle of rotation is controlled in real-time. Additionally, the position transmitter allows positioner faults to be indi-

cated over a signal current of <2.4 mA or >21.6 mA.

Leakage sensor



By upgrading the positioner with a leakage sensor, it is possible to detect seat leakage when the valve is in the closed position. Details on EXPERTplus Valve Diagnostics in the Operating Instructions ► EB 8389-1.

Binary input

The optional binary input can be configured:

- To connect a floating contact
- To connect a non-floating contact (0 to 24 V DC)

By selecting a certain function, one of the following actions can be activated:

- Transmit switching state
The switching state of the binary input is logged.
- Activate local write protection
After the first initialization, a local write protection can be activated. While the binary input is active, no settings can be changed at the positioner. The positioner cannot be re-initialized. Enabling configuration over Code 3 is not active (🔒).
- Switch AUTO/MAN
The positioner changes from the automatic mode  (AUTO) to the manual mode  (MAN) or vice versa. This function is not performed if the positioner is in the fail-safe position mode (SAFE).

- Various diagnostic functions in Operating Instructions ► EB 8389-1 (EXPERTplus valve diagnostics)

Additionally, the external solenoid valve function can be selected if a non-floating contact is configured:

- External solenoid valve
The voltage for an external solenoid valve is connected in parallel to terminals +31/–32. This allows the switching state of the solenoid valve to be monitored.

Note

The optional binary input can only be configured using the operator software, e.g. TROVIS-VIEW. The switching state is transmitted when the switch is closed by default.

External position sensor

In this version, only the sensor is mounted to the control valve. The positioner is located separately from the valve. The connection of x and y signals to the valve is established by cable and piping for air.

3.2 Attachment versions

The positioner is suitable for the following types of attachment using the corresponding accessories:

- Direct attachment to SAMSON Type 3277 Actuator
- Attachment to actuators according to IEC 60534-6
- Attachment according to VDI/VDE 3847-1/-2

Design and principle of operation

- Attachment to Type 3510 Micro-flow Valve
- Attachment to rotary actuators according to VDI/VDE 3845

3.3 Communication

The positioner is equipped with an interface for HART® protocol (Highway Addressable Remote Transducer) for communication purposes. Data are transmitted in a superimposed frequency (FSK = Frequency Shift Keying) on the existing signal loop for the 4 to 20 mA set point.

Either a HART® capable handheld communicator or a computer with FSK modem can be used to establish communication and operate the positioner.

i Note

The HART® device revision as well as the indicating and operating modules supported by the Type 3730-6 Positioner can be found on the SAMSON website (► www.samsongroup.com > SERVICE & SUPPORT > Downloads > Device integration > 3730-6 > 'Device Revision' to 'Firmware' assignment).

3.4 Configuration using the TROVIS-VIEW software

The positioner can be configured with SAMSON's TROVIS-VIEW Software.

The positioner has for this purpose a **serial interface** to allow the RS-232 or USB port of a computer to be connected to it using an adapter cable.

The TROVIS-VIEW software enables the user to easily configure the positioner as well as view process parameters online.

i Note

TROVIS-VIEW provides a uniform user interface that allows users to configure and parameterize various SAMSON devices using device-specific database modules. The device module 3730-6 can be downloaded free of charge from our website at

► www.samsongroup.com > SERVICE & SUPPORT > Downloads > TROVIS-VIEW. Further information on TROVIS-VIEW (e.g. system requirements) is available on our website and in the Data Sheet ► T 6661.

3.5 Technical data

Table 3-1: Type 3730-6 Electropneumatic Positioner

Type 3730-6 Positioner		
The listed technical data for the explosion-protected devices may be further restricted by the limits specified in the test certificates.		
Travel	Adjustable	Direct attachment to Type 3277 Actuator: 3.6 to 30 mm Attachment according to IEC 60534-6-1: 3.6 to 300 mm Attachment according to VDI/VDE 3847: 3.6 to 300 mm Rotary actuators: 24 to 100° opening angle
Travel range	Adjustable	Adjustable within the initialized travel/angle of rotation; travel can be restricted to 1/5 at the maximum
Set point w	Signal range	4 to 20 mA · Two-wire device, reverse polarity protection · Minimum span 4 mA
	Static destruction limit	30 V
Minimum current		3.6 mA for display · Emergency venting at ≤3.8 mA or ≤4.4 mA depending on version
Load impedance		≤9.2 V (corresponding to 460 Ω at 20 mA)
Supply	Supply air	1.4 to 7 bar (20 to 105 psi)
	Air quality acc. to ISO 8573-1 (edition 2001-02)	Maximum particle size and density: Class 4 · Oil content: Class 3 Pressure dew point: Class 3 or at least 10 K below the lowest ambient temperature to be expected
Signal pressure (output)		0 bar up to the supply pressure · Can be limited between 1.4 and 7.0 bar by software
Characteristic	Adjustable	Linear/Equal percentage/Reverse equal percentage User-defined (over operator software) Butterfly valve, rotary plug valve and segmented ball valve: Linear/equal percentage
	Deviation	≤1 %
Hysteresis		≤0.3 %
Sensitivity		≤0.1 %
Transit time		Exhaust and supply adjustable separately up to 240 s by software
Direction of action		Reversible
Air consumption, steady state		Independent of supply air approx. 110 I _n /h
Air output capacity	Actuator (supply)	At Δp = 6 bar: 8.5 m _n ³ /h · At Δp = 1.4 bar: 3.0 m _n ³ /h · K _{v,max(20 °C)} = 0.09
	Actuator (exhaust)	At Δp = 6 bar: 14.0 m _n ³ /h · At Δp = 1.4 bar: 4.5 m _n ³ /h · K _{v,max(20 °C)} = 0.15
Permissible ambient temperature		-20 to +80 °C for all versions -45 to +80 °C with metal cable gland The temperature limits for the explosion-protected devices may be restricted by the limits specified in the test certificates.

Design and principle of operation

Type 3730-6 Positioner		
Influences	Temperature	≤0.15 %/10 K
	Supply air	None
	Effect of vibration	≤0.25 % up to 2000 Hz and 4 g according to IEC 770
Electromagnetic compatibility		Complying with EN 61000-6-2, EN 61000-6-3, EN 61326-1 and NAMUR Recommendation NE 21
Electrical connections		One M20x1.5 cable gland for 6 to 12 mm clamping range · Second M20x1.5 threaded connection additionally exists · Screw terminals for 0.2 to 2.5 mm ² wire cross-sections
Degree of protection		IP 66/NEMA 4X
Certified according to IEC 61508/SIL		Suitable for use in safety-instrumented systems up to SIL 2 (single device/HFT = 0) and SIL 3 (redundant configuration/HFT = 1) according to IEC 61511. <ul style="list-style-type: none"> • Triggered by the set point, emergency venting depending on positioner version at ≤3.8 mA or ≤4.4 mA • By the optional solenoid valve, emergency venting at 0 V • By the optional forced venting function, emergency venting at <12 V
Communication (local)		SAMSON SSP interface and serial interface adapter, software requirements (SSP): TROVIS-VIEW with database module 3730-6
Communication (HART®)		HART® field communications protocol · Impedance in HART® frequency range: Receiving 350 to 450 Ω · Sending approx. 115 Ω
Software requirements (HART®)	For handheld requirements communicator	Device description for Type 3730-6
	For computer	DTM file according to specification 1.2, suitable for integrating the device into frame applications that support the use of FDT/DTM (e.g. PACTware)
Explosion protection		
Refer to Table 3-3		
Binary contacts		
Two software limit switches, reverse polarity protection, floating, configurable switching characteristics		
Signal state	No response	≤1.0 mA
	Response	≥2.2 mA
One fault alarm contact, floating		
Signal state	No response	≥2.2 mA · No fault alarm
	Response	≤1.0 mA · Fault alarm
For connection to		NAMUR switching amplifier acc. to EN 60947-5-6
Materials		
Housing		Die-cast aluminum EN AC-ALSi12[Fe] (EN AC-44300) acc. to DIN EN 1706, chromate and powder coating · Special version: stainless steel 1.4408
External parts		Stainless steel 1.4404/316L

Type 3730-6 Positioner	
Cable gland	M20x1.5, black polyamide
Weight	Approx. 1.0 kg · Stainless steel version: 2.2 kg
Conformity	

Table 3-2: Optional additional functions

Electronic forced venting · Approval acc. to IEC 61508/SIL	
Input	24 V DC · Electrical isolation and reverse polarity protection · Static destruction limit 40 V Power draw: $I = \frac{U - 5.7 V}{3.84 k\Omega}$ (corresponding to 4.8 mA at 24 V/114 mW)
Signal '0' (no response)	<12 V (emergency venting at 12 V)
Signal '1' (response)	>19 V
Solenoid valve · Approval acc. to IEC 61508/SIL	
Input	24 V DC · Reverse polarity protection · Static destruction limit 40 V Power draw: $I = \frac{U - 5.7 V}{3.84 k\Omega}$ (corresponding to 4.8 mA at 24 V/114 mW)
Signal '0' (no response)	<12 V (emergency venting at 0 V)
Signal '1' (response)	>19 V
Service life	>5 x 10 ⁶ switching cycles
Analog position transmitter Two-wire transmitter · Galvanically isolated	
Supply	12 to 30 V DC · Reverse polarity protection · Static destruction limit 40 V
Output signal	4 to 20 mA
Operating direction	Reversible
Operating range	-10 to +114 %
Characteristic	Linear
Hysteresis	Same as positioner
High-frequency influence	Same as positioner
Other influences	Same as positioner
Fault alarm	Can be issued as current signal 2.4 ±0.1 mA or 21.6 ±0.1 mA
Leakage sensor · Suitable for operation in hazardous areas	
Temperature range	-40 to +130 °C
Tightening torque	20 ±5 Nm

Design and principle of operation

Inductive limit switch by Pepperl+Fuchs	For connection to switching amplifier acc. to EN 60947-5-6 Can be used in combination with a software limit switch
SJ2-SN proximity switch	Measuring plate not detected: ≥ 3 mA · Measuring plate detected: ≤ 1 mA
External position sensor	
Travel	Same as positioner
Cable	10 m · Flexible and durable · With M12x1 connector · Flame-retardant according to VDE 0472 · Resistant to oils, lubricants and coolants as well as other aggressive media
Permissible ambient temperature	-40 to +90 °C with a fixed connection between positioner and position sensor · The limits in the test certificate additionally apply for explosion-protected versions.
Immunity to vibration	Up to 10 g in the range of 10 to 2000 Hz
Degree of protection	IP 67
Binary input · Galvanic isolation · Switching behavior configured by software	
Active switching behavior (default setting)	
Connection	For external switch (floating contact) or relay contact
Electric data	Open-circuit voltage when contact is open: max. 10 V Pulsed DC current reaching peak value of 100 mA and RMS value of 0.01 mA when contact is closed
Contact	Closed, $R < 20 \Omega$ ON switching state (default setting)
	Open, $R > 400 \Omega$ OFF switching state (default setting)
Passive switching behavior	
Connection	For externally applied DC voltage, reverse polarity protection
Electric data	3 to 30 V · Static destruction limit 40 V · Power draw 3.7 mA at 24 V
Voltage	>6 V ON switching state (default setting)
	<1 V OFF switching state (default setting)

Table 3-3: Summary of explosion protection approvals (up to date at the time of publication of this document)

Type 3730-6	Certification		Type of protection
-110	Number	PTB 10 ATEX 2007	II 2 G Ex ia IIC T6 Gb
	Date	2020-01-20	II 2 D Ex ia IIIC T80 °C Db
-210	Number	PTB 10 ATEX 2007	II 2 G Ex d[ia] IIC T6 Gb
	Date	2020-01-20	II 2 D Ex tb IIIC T80 °C Db
-510	Number	PTB 10 ATEX 2007	II 2 D Ex tb IIIC T80 °C Db
	Date	2020-01-20	
-810	Number	PTB 10 ATEX 2008X	II 3 G Ex nA ic IIC T6 Gc
	Date	2010-08-18	II 3 D Ex tc IIIC T80°C Dc IP66
-131	Number	2682094	Ex ia IIC T4/T5/T6; Class I, Zone 0 Class I, Groups A,B,C, and D Class II Groups E,F and G; Class III; Type 4 Enclosure
	Date	2017-05-24	
-112	Number	2020322307003192	Ex ia IIC T4...T6 Gb Ex ia IIIC T80°C Db
	Date	2023-04-29	
	Valid until	2025-11-08	
-512	Number	2020322307003192	Ex tb IIIC T80°C Db
	Date	2023-04-29	
	Valid until	2025-11-08	
-130	Number	3012394	Intrinsically safe: IS, Class I, II, III, Div. 1, Gr. A, B, C, D, E, F, G ATEX ia IIC / Class I / Zone 0 Non incandive: NI, Class I, Div. 2, Gr. A, B, C, D S, Class II, Div. 2, Gr. F, G Enclosure Type 4X
	Date	2014-11-05	

Design and principle of operation

Type 3730-6	Certification		Type of protection
-111	Number	IECEX PTB 10.0057	Ex ia IIIC T80 °C Db Ex ia IIC T6 Gb
	Date	2020-09-17	
-211	Number	IECEX PTB 10.0057	Ex db[ia] IIC T6 Gb Ex tb IIIC T80 °C Db
	Date	2020-09-17	
-511	Number	IECEX PTB 10.0057	Ex tb IIIC T80°C Db
	Date	2020-09-17	
-811	Number	IECEX PTB 10.0058X	Ex nA IIC T6 Ex nL IIC T6 Ex tD A22 IP 66 T80 °C
	Date	2010-12-10	
-116	Number	ZETC/35/2021	II 2G Ex ia IIC T6 Gb II 2D Ex ia IIIC T80 °C Db
	Date	2021-07-26	
	Valid until	2024-07-25	
-516	Number	ZETC/35/2021	II 2D Ex tb IIIC T80°C Db
	Date	2021-07-26	
	Valid until	2024-07-25	
-816	Number	ZETC/35/2021	II 3G Ex nA IIC T6 Gc II 3D Ex tc IIIC T80°C Dc
	Date	2021-07-26	
	Valid until	2024-07-25	

3.6 Dimensions in mm

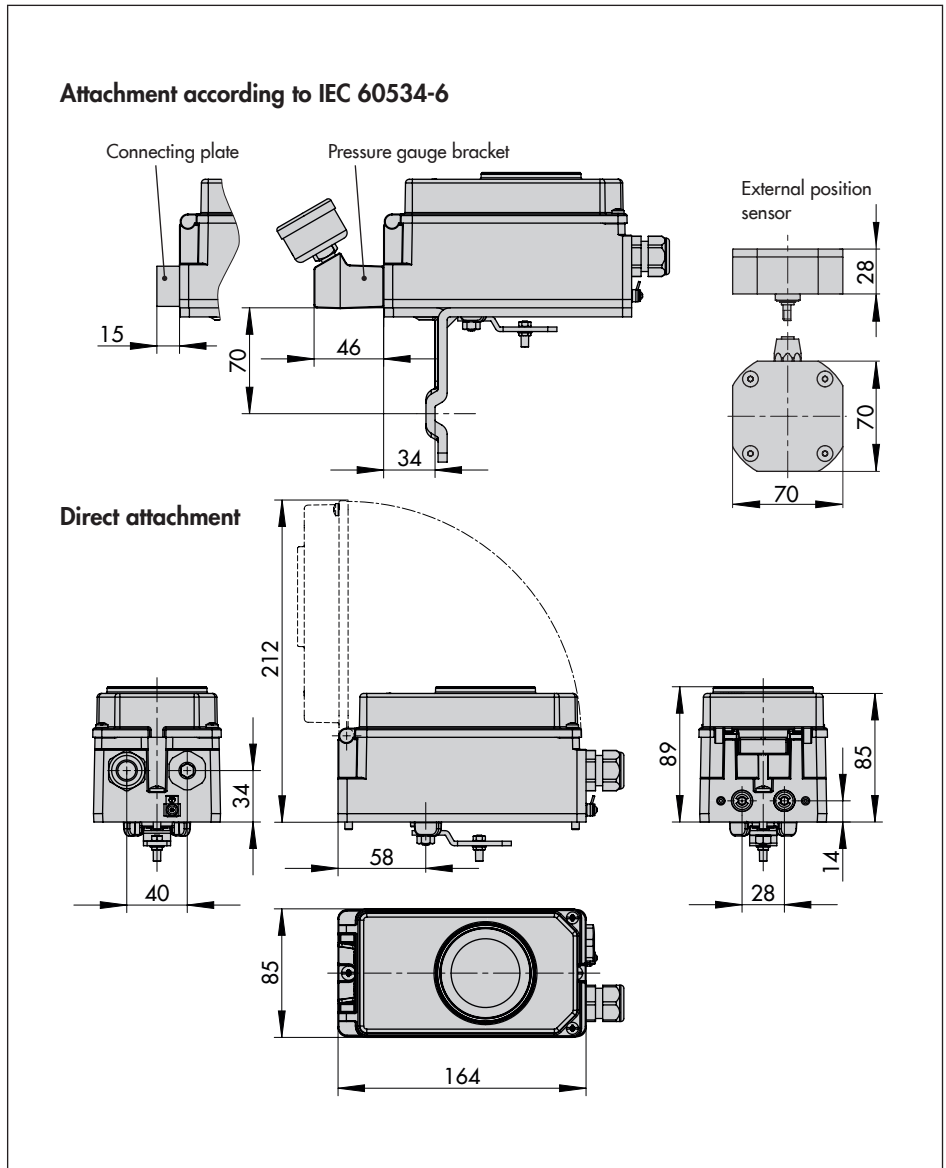

Attachment according to VDI/
VDE 3847-1 onto Type 3277 Actuator

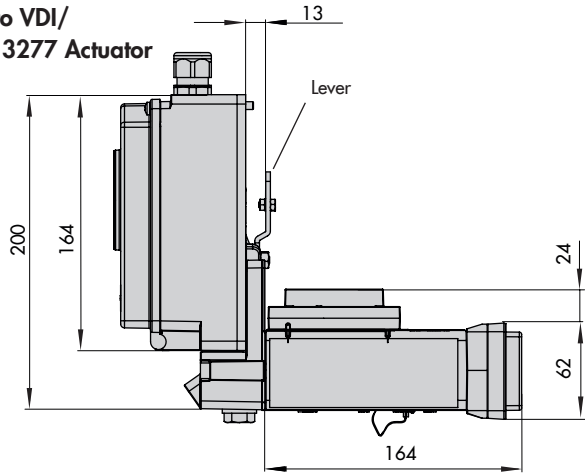

Attachment according to VDI/
VDE 3847-1 to a NAMUR rib

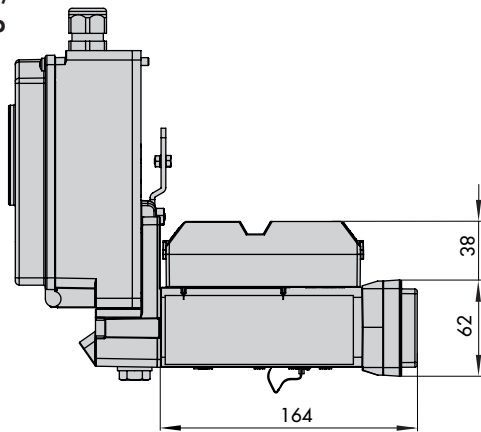

**Attachment according to VDI/VDE 3847-2
with single-acting actuator**

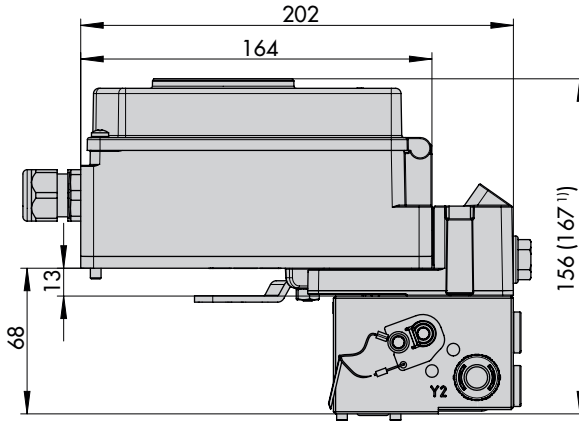

**Attachment according to VDI/VDE 3847-2
with double-acting actuator**

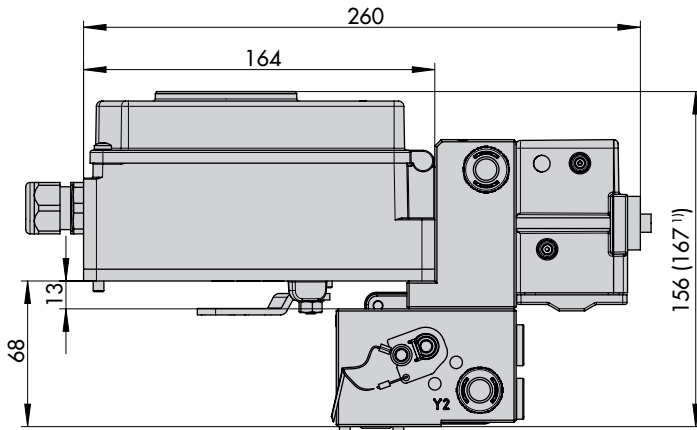

Attachment to rotary actuators according to VDI/VDE 3845

Heavy-duty version

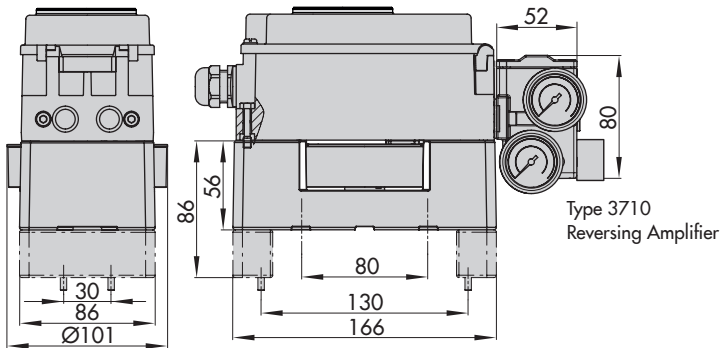

Light version

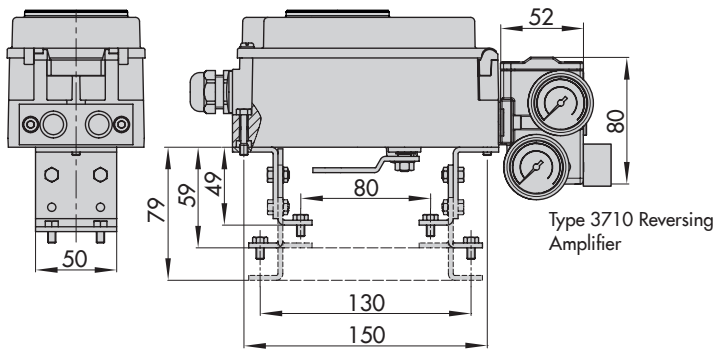

Lever

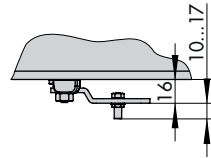
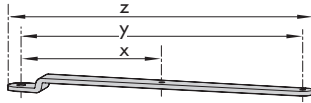

Lever	x	y	z
S	17 mm	25 mm	33 mm
M	25 mm	50 mm	66 mm
L	70 mm	100 mm	116 mm
XL	100 mm	200 mm	216 mm
XXL	200 mm	300 mm	316 mm

3.6.1 Fixing levels according to VDI/VDE 3845 (September 2010)

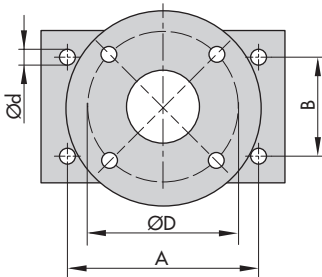
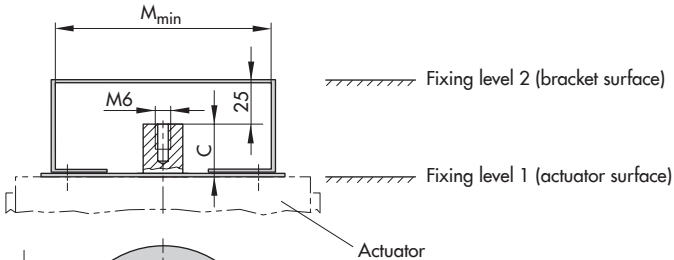

Dimensions in mm						
Size	A	B	C	Ød	M _{min}	D ¹⁾
AA0	50	25	15	5.5 for M5	66	50
AA1	80	30	20	5.5 for M5	96	50
AA2	80	30	30	5.5 for M5	96	50
AA3	130	30	30	5.5 for M5	146	50
AA4	130	30	50	5.5 for M5	146	50
AA5	200	50	80	6.5 for M6	220	50

¹⁾ Flange type F05 acc. to DIN EN ISO 5211

4 Shipment and on-site transport

The work described in this chapter is only to be performed by personnel appropriately qualified to carry out such tasks.

4.1 Accepting the delivered goods

After receiving the shipment, proceed as follows:

1. Check the scope of delivery. Check that the specifications on the nameplate of the positioner match the specifications in the delivery note. See the 'Markings on the device' chapter for nameplate details.
2. Check the shipment for transportation damage. Report any damage to SAMSON and the forwarding agent (refer to delivery note).

4.2 Removing the packaging from the positioner

Observe the following sequence:

- Do not remove the packaging and the protective caps on the pneumatic ports until immediately before installation.
- Dispose and recycle the packaging in accordance with the local regulations.

4.3 Transporting the positioner

- Pack the positioner properly to comply with terms of transportation.

Transport instructions

- Protect the positioner against external influences (e.g. impact).
- Protect the positioner against moisture and dirt.
- Observe transport temperature depending on the permissible ambient temperature (see the 'Design and principle of operation' chapter).

4.4 Storing the positioner

! NOTICE

Risk of device damage due to improper storage.

- *Observe the storage instructions.*
 - *Avoid long storage times.*
 - *Contact SAMSON in case of different storage conditions.*
-

i Note

We recommend regularly checking the control valve and the prevailing storage conditions during long storage periods.

Shipment and on-site transport

Storage instructions

- Protect the positioner against external influences (e.g. impact, shocks, vibration).
- Do not damage the corrosion protection (coating).
- Protect the positioner against moisture and dirt. In damp spaces, prevent condensation. If necessary, use a drying agent or heating.
- Make sure that the ambient air is free of acids or other corrosive media.
- Observe storage temperature depending on the permissible ambient temperature (see the 'Design and principle of operation' chapter).
- Store the positioner with the cover closed.
- Seal the pneumatic and electrical connections.
- Do not place any objects on the positioner.

5 Installation

The work described in this chapter is only to be performed by personnel appropriately qualified to carry out such tasks.

⚠ DANGER

Risk of fatal injury due to the ignition of an explosive atmosphere.

- Observe EN 60079-14 (VDE 0165, Part 1) for work on the positioner in potentially explosive atmospheres.
- Work in potentially explosive atmospheres must only be performed by personnel who has undergone special training or instructions or who is authorized to work on explosion-protected devices in hazardous areas.

⚠ WARNING

Crush hazard arising from moving parts on the valve.

- Do not touch any moving valve parts while the control valve is in operation.
- Before performing any mounting or installation work on the positioner, put the control valve out of operation by disconnecting and locking the supply air and control signal.
- Do not impede the movement of the actuator and plug stem by inserting objects into the yoke.

ⓘ NOTICE

Risk of malfunction due to incorrect mounting parts/accessories.

- Only use the mounting parts and accessories listed in these mounting and operating instructions to mount and install the positioner. Pay special attention to the type of attachment.

5.1 Installation conditions

Work position

The work position for the positioner is the front view onto the operating controls on the positioner seen from the position of operating personnel.

Operators must ensure that, after installation of the positioner, the operating personnel can perform all necessary work safely and easily access the device from the work position.

Mounting orientation

- Observe mounting position (see Fig. 5-2).
- Do not seal or restrict the vent opening (see Fig. 5-1) when the device is installed on site.

5.2 Preparation for installation

Before mounting, make sure the following conditions are met:

- The positioner is not damaged.
- The air supply is not yet connected to the positioner.
- The current is not yet connected to the positioner.

Proceed as follows:

- ➔ Lay out the necessary material and tools to have them ready during mounting.
- ➔ Adjust correct lever and pin position (see Chapter 5.3).
- ➔ Seal the signal pressure output at the back with the screw plug (4, order no. 0180-1436) and the associated O-ring (order no. 0520-0412) if not already been done so.
- ➔ Remove the protective caps from the pneumatic connections.

5.3 Adjusting the lever and pin position

i Note

The M lever is included in the scope of delivery.

S, L and XL levers are available as accessories (see Chapter 5.12).

The XXL lever is available on request.

The positioner is adapted to the actuator and to the rated travel by the lever on the back of

the positioner and the pin inserted into the lever.

The travel tables on page 5-4 show the maximum adjustment range at the positioner. The travel that can be implemented at the valve is additionally restricted by the selected fail-safe position and the required compression of the actuator springs.

The positioner is equipped with the **M** lever (pin position 35) as standard (see Fig. 5-3). If a pin position other than position 35 with the standard **M** lever is required or an **L** or **XL** lever size is required, proceed as follows (see Fig. 5-4):

1. Unthread the nut (1.1) to unfasten the mounted lever.
 - ➔ Make sure that the lever does not rest on the end stops.
2. Fasten the follower pin (2) in the assigned lever hole (pin position as specified in the travel tables on page 5-4). Only use the longer follower pin included in the mounting kit.
3. Place the lever (1) on the shaft of the positioner and fasten it tight using the disk spring (1.2) and nut (1.1).
 - ➔ Make sure that the lever does not rest on the end stops.

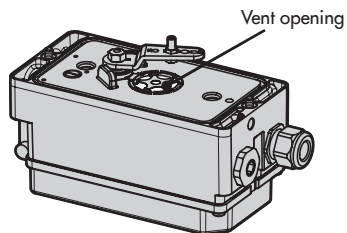

Fig. 5-1: Vent opening
(back of the positioner)

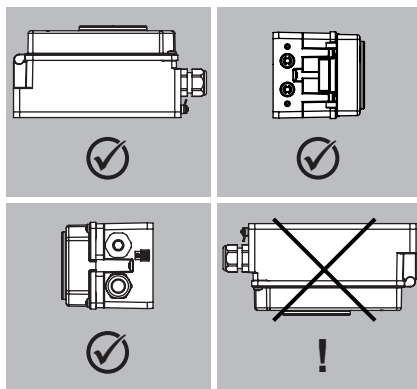
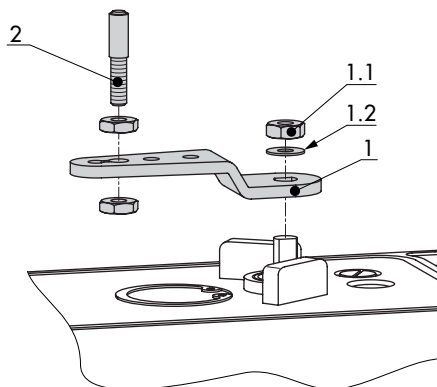

Fig. 5-2: Permissible mounting positions



- 1 Lever
- 1.1 Nut
- 1.2 Disk spring
- 2 Follower pin

Fig. 5-4: Mounting the lever and follower pin

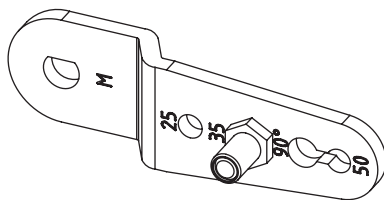

Fig. 5-3: M lever with pin position 35

5.3.1 Travel tables

Table 5-1: Direct attachment to Type 3277-5 and Type 3277 Actuator

Actuator size [cm ²]	Rated travel [mm]	Adjustment range at positioner ¹⁾	Required lever	Assigned pin position
		Travel [mm]		
120	7.5	5.0 to 25.0	M	25
120/175/240/350	15	7.0 to 35.0	M	35
355/700/750	30	10.0 to 50.0	M	50

¹⁾ The min./max. adjustment range is based on the NOM (nominal range) initialization mode

Table 5-2: Attachment according to IEC 60534-6 (NAMUR)

SAMSON valves with Type 3271 Actuator		Adjustment range at positioner Other control valves ¹⁾		Required lever	Assigned pin position
Actuator size [cm ²]	Rated travel [mm]	Min. travel [mm]	Max. travel [mm]		
60 and 120 with Type 3510 Valve	7.5	3.6	18.0	S	17
120	7.5	5.0	25.0	M	25
120/175/240/350	15	7.0	35.0	M	35
355/700/750	7.5	7.0	35.0	M	35
355/700/750	15 and 30	10.0	50.0	M	50
1000/1400/2800	30	14.0	70.0	L	70
	60	20.0	100.0	L	100
1400/2800	120	40.0	200.0	XL	200
See manufacturer's specifications	200	See manufacturer's specifications			300

¹⁾ The min./max. adjustment range is based on the NOM (nominal range) initialization mode

Table 5-3: Attachment to rotary actuators

Opening angle	Required lever	Assigned pin position
24 to 100°	M	90°

5.4 Positioner attachment

5.4.1 Direct attachment

a) Type 3277-5 Actuator

- ➔ Required mounting parts and accessories: Table 5-5
- ➔ Observe the travel table on page 5-4.

Actuator with 120 cm² (see Fig. 5-5)

The signal pressure from the positioner is routed over the signal pressure connection of the connecting plate (9, Fig. 5-23 left) to the actuator diaphragm chamber. To proceed, first screw the connecting plate (9) included in the accessories onto the actuator yoke.

- Turn connecting plate (9) so that the correct symbol for the fail-safe action "actuator stem extends" or "actuator stem retracts" is aligned with the marking (Fig. 5-23, below).
 - ➔ Make sure that the gasket for the connecting plate (9) is correctly inserted.
 - The connecting plate has threaded holes with NPT and G threads. Seal the threaded connection that is not used with the rubber seal and square plug.
4. Mount connecting plate (6) or pressure gauge bracket (7) with pressure gauges on the positioner, making sure the two seals (6.1) are seated properly.
 5. Place follower clamp (3) on the actuator stem, align it and screw tight so that the

mounting screw is located in the groove of the actuator stem.

6. Mount cover plate (10) with narrow side of the cut-out (Fig. 5-5, on the left) pointing towards the signal pressure connection. Make sure that the gasket (14) points towards the actuator yoke.
7. **15 mm travel:** Keep the follower pin (2) on the M lever (1) on the back of the positioner in the pin position 35 (delivered state).
 - 7.5 mm travel:** Remove the follower pin (2) from the pin position 35, reposition it in the hole for pin position 25 and screw tight.
8. Insert molded seal (15) into the groove of the positioner housing and insert the seal (10.1) on the back of the housing.
9. Place positioner on the cover plate (10) in such a way that the follower pin (2) rests on the top of the follower clamp (3). Adjust the lever (1) correspondingly and open the positioner cover to hold the positioner shaft in position at the cap or rotary pushbutton. The lever (1) must rest on the follower clamp with spring force. Fasten the positioner on the cover plate (10) using the two fastening screws.
10. Mount cover (11) on the other side.
 - ➔ Make sure that the vent plug is located at the bottom when the control valve is installed to allow any condensed water that collects to drain off.

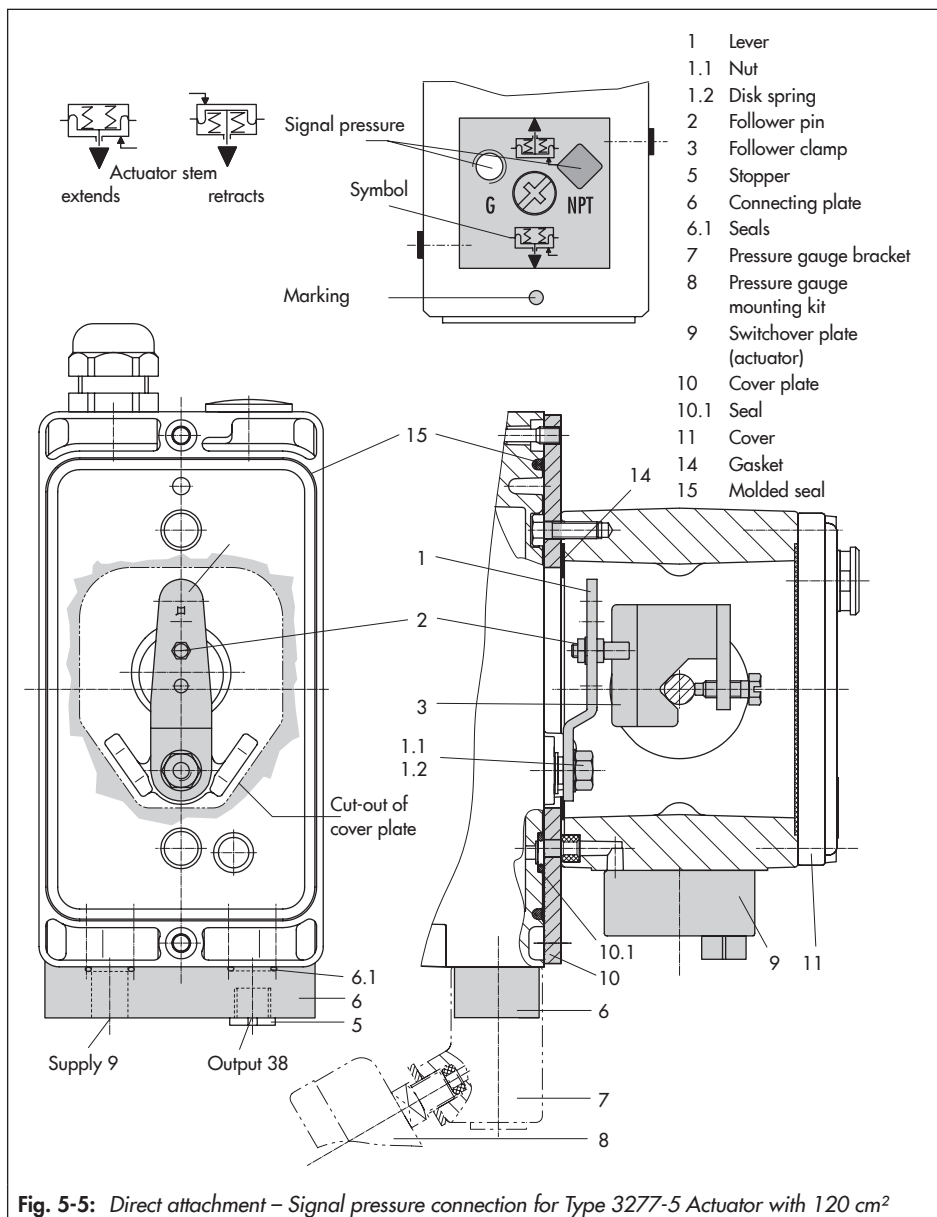

Fig. 5-5: Direct attachment – Signal pressure connection for Type 3277-5 Actuator with 120 cm²

b) Type 3277 Actuator

→ Required mounting parts and accessories: Table 5-6

→ Observe the travel table on page 5-4.

Actuators with 175 to 750 cm² effective areas (see Fig. 5-6)

Mount the positioner on the yoke. The signal pressure is routed to the actuator over the connection block (12), for actuators with fail-safe action "actuator stem extends" internally through a hole in the valve yoke and for "actuator stem retracts" through an external pipe.

1. Place follower clamp (3) on the actuator stem, align it and screw tight so that the mounting screw is located in the groove of the actuator stem.
2. Mount cover plate (10) with narrow side of the cut-out (Fig. 5-6, on the left) pointing towards the signal pressure connection. Make sure that the gasket (14) points towards the actuator yoke.
3. For actuators with 355, 700 or 750 cm², remove the follower pin (2) on the M lever (1) on the back of the positioner from pin position 35, reposition it in the hole for pin position 50 and screw tight. For actuators 175, 240 and 350 cm² with 15 mm travel, keep the follower pin (2) in pin position 35.
4. Insert molded seal (15) into the groove of the positioner housing.
5. Place positioner on the cover plate in such a way that the follower pin (2) rests on the top of the follower clamp (3). Ad-

just the lever (1) correspondingly and open the positioner cover to hold the positioner shaft in position at the cap or rotary pushbutton. The lever (1) must rest on the follower clamp with spring force. Fasten the positioner on the cover plate (10) using the two fastening screws.

6. Make sure that the tip of the gasket (16) projecting from the side of the connection block is positioned to match the actuator symbol for the actuator's fail-safe action "actuator stem extends" or "actuator stem retracts". If this is not the case, unscrew the three fastening screws and lift off the cover. Turn the gasket (16) by 180° and re-insert it.
The old connection block version (Fig. 5-6, bottom) requires the switch plate (13) to be turned to align the actuator symbol with the arrow marking.
7. Place the connection block (12) with the associated seals against the positioner and the actuator yoke and fasten using the screw (12.1). For actuators with fail-safe action "actuator stem retracts", additionally remove the stopper (12.2) and mount the external signal pressure pipe.
8. Mount cover (11) on the other side.
→ Make sure that the vent plug is located at the bottom when the control valve is installed to allow any condensed water that collects to drain off.

5.4.2 Attachment according to IEC 60534-6

- See Fig. 5-7
- Required mounting parts and accessories: Table 5-7
- Observe the travel table on page 5-4.

The positioner is attached to the control valve using a NAMUR bracket (10).

1. Screw the two bolts (14) to the bracket (9.1) of the stem connector (9), place the follower plate (3) on top and use the screws (14.1) for fastening.

Actuator sizes 2800 cm² and 1400 cm² with 120 mm travel:

- For a travel of 60 mm or smaller, screw the longer follower plate (3.1) directly to the stem connector (9).
 - For a travel exceeding 60 mm, mount the bracket (16) first and then the follower plate (3) to the bracket together with the bolts (14) and screws (14.1).
2. Mount NAMUR bracket (10) to the control valve as follows:
 - For **attachment to the NAMUR rib**, use an M8 screw (11) and toothed lock washer directly in the yoke hole.
 - For attachment to **valves with rod-type yokes**, use two U-bolts (15) around the yoke. Align the NAMUR bracket (10) according to the embossed scale so that the follower plate (3) is shifted by half the angle range to the NAMUR bracket (the slot of the follower plate is centrally

aligned with the NAMUR bracket at mid valve travel).

3. Mount connecting plate (6) or pressure gauge bracket (7) with pressure gauges on the positioner, making sure the two seals (6.1) are seated properly.
4. Select required lever size (1) M, L or XL and pin position according to the actuator size and valve travel listed in the travel table on page 5-4.

If a pin position other than position **35** with the standard **M** lever is required or an **L** or **XL** lever size is required. Proceed as described in Chapter 5.3.

5. Place positioner on the NAMUR bracket in such a way that the follower pin (2) rests in the slot of the follower plate (3, 3.1). Adjust the lever (1) correspondingly.
Screw the positioner to the NAMUR bracket using its two fastening screws.

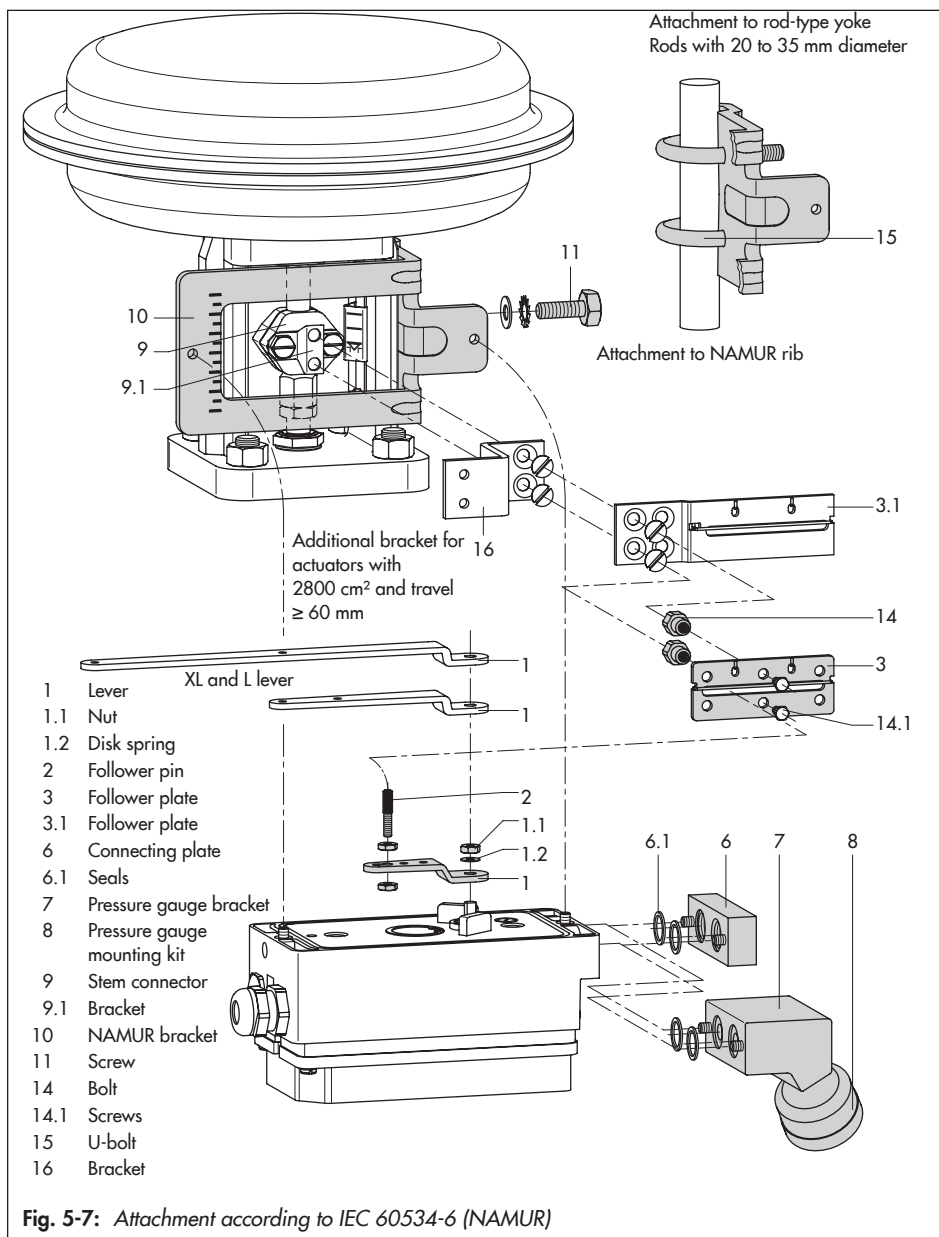

5.4.3 Attachment according to VDI/VDE 3847-1

The Type 3730-6-xxx0xxxx0x0060xx and Type 3730-6-xxx0xxxx0x007000 Positioners with air purging of the actuator's spring chamber can be attached according to VDI/VDE 3847-1.

The Type 3730-6-xxx0xxxx0x0000xx Positioner without air purging of the actuator's spring chamber can be attached according to VDI/VDE 3847.

This type of attachment allows the positioner to be replaced quickly while the process is running by blocking the air in the actuator. The signal pressure can be blocked in the actuator by unscrewing the red retaining screw (20) and turning the air blocker (19) on the bottom of the adapter block.

Attachment to Type 3277 Actuator (see Fig. 5-8)

→ Required mounting parts and accessories: see Table 5-8

Mount the positioner on the yoke as shown in Fig. 5-8. The signal pressure is routed to the actuator over the connecting plate (12), for actuators with fail-safe action "actuator stem extends" internally through a bore in the valve yoke and for "actuator stem retracts" through external piping.

Only the Y1 port is required for positioner attachment. The Y2 port can be used for air purging of the spring chamber.

1. Place follower clamp (3) on the actuator stem, align it and screw tight so that the

mounting screw is located in the groove of the actuator stem.

2. Place the adapter bracket (6) on the positioner and mount using the screws (6.1). Make sure that the seals are correctly seated. For positioners **with air purging**, remove the stopper (5) before mounting the positioner. For positioners **without air purging**, replace the screw plug (4) with a vent plug.
3. For actuators with 355, 700 or 750 cm², remove the follower pin (2) on the M lever (1) on the back of the positioner from pin position 35, reposition it in the hole for pin position 50 and screw tight.

For actuators 175, 240 and 350 cm² with 15 mm travel, keep the follower pin (2) in pin position 35.

4. Insert the molded seal (6.2) in the groove of the adapter bracket (6).
5. Insert the molded seal (17.1) into the turnboard (17) and mount the turnboard to the adapter block (13) using the screws (17.2).
6. Mount the blank plate (18) to the turnboard (17) using the screws (18.1). Make sure that the seals are correctly seated.

i Note

A solenoid valve can also be mounted in place of the blank plate (18). The orientation of the turnboard (17) determines the mounting position of the solenoid valve. Alternatively, a restrictor plate can be mounted (► AB 11).

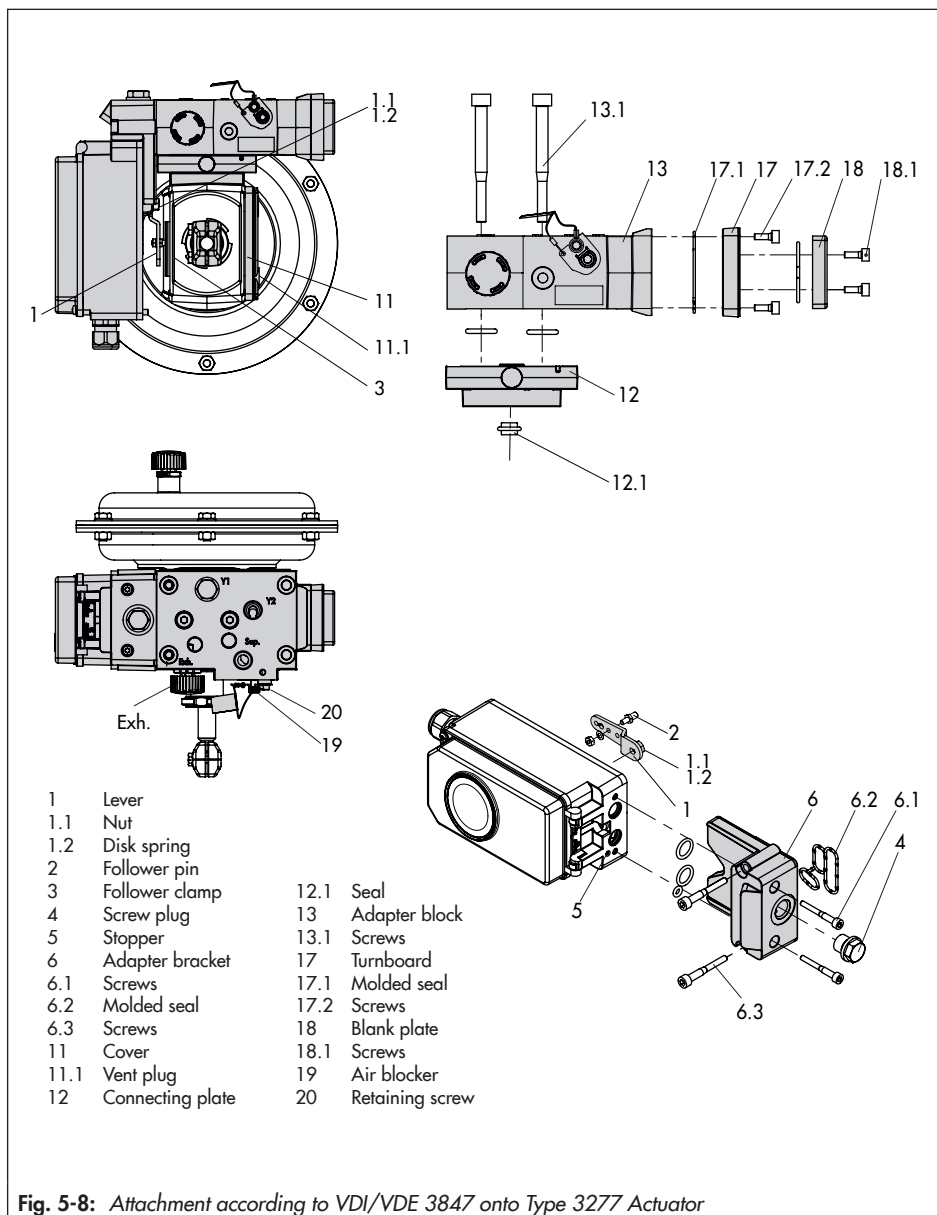

Installation

7. Insert the screws (13.1) through the middle holes of the adapter block (13).
8. Place the connecting plate (12) together with the seal (12.1) onto the screws (13.1) corresponding to the fail-safe action "actuator stem extends" or "actuator stem retracts". The fail-safe action that applies is determined by aligning the groove of the adapter block (13) with the groove of the connecting plate (12) (Fig. 5-9).

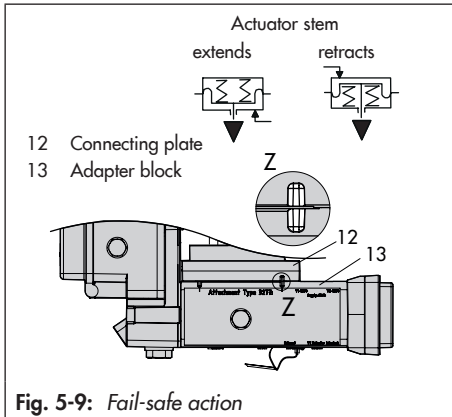

9. Mount the adapter block (13) together with the connecting plate (12) to the actuator using the screws (13.1).
10. Insert the vent plug (11.1) into the **Exh.** connection.
11. For fail-safe action "actuator stem extends", seal the Y1 port with a blanking plug.
For fail-safe action "actuator stem retracts", connect the Y1 port to the signal pressure connection of the actuator.

Place positioner on the adapter block (13) in such a way that the follower pin (2) rests on the top of the follower clamp (3). Adjust the lever (1) correspondingly and open the positioner cover to hold the positioner shaft in position at the cap or rotary pushbutton.

The lever (1) must rest on the follower clamp with spring force.

Fasten the positioner to the adapter block (13) using the two fastening screws (6.3). Make sure the molded seal (6.2) is properly seated.

12. Mount cover (11) on the other side to the yoke.

➔ Make sure that the vent plug is located at the bottom when the control valve is installed to allow any condensed water that collects to drain off.

Attachment to NAMUR rib (see Fig. 5-10)

- Required mounting parts and accessories: see Table 5-8
- Observe the travel table on page 5-4.

1. **Series 240 Valves, actuator size up to 1400-60 cm²:** Screw the two bolts (14) to the bracket of the stem connector or directly to the stem connector (depending on the version), place the follower plate (3) on top and use the screws (14.1) to fasten it.

Type 3251 Valve, 350 to 2800 cm²:

Screw the longer follower plate (3.1) to the bracket of the stem connector or directly to the stem connector (depending on the version).

Type 3254 Valve, 1400-120 to 2800 cm²:

Screw the two bolts (14) to the bracket (16). Fasten the bracket (16) onto the stem connector, place the follower plate (3) on top and use the screws (14.1) to fasten it.

Mount the positioner on the NAMUR rib as shown in Fig. 5-10.

2. For **attachment to the NAMUR rib**, fasten the NAMUR connection block (10) directly into the existing yoke bore using the screw and toothed lock washer (11). Align the marking on the NAMUR valve connection (on the side marked '1') to 50 % travel.

For attachment to **valves with rod-type yokes** using the formed plate (15), which is placed around the yoke: screw the four studs into the NAMUR connection block (10). Place the NAMUR connection block on the rod and position the formed plate (15) on the opposite side. Use the nuts and toothed lock washers to fasten the formed plate onto the studs. Align the marking on the NAMUR valve connection (on the side marked '1') to 50 % travel.

3. Place the adapter bracket (6) on the positioner and mount using the screws (6.1). Make sure that the seals are correctly seated. For positioners **with air purging**, remove the stopper (5) before mounting the positioner. For positioners **without air purging**, replace the screw plug (4) with a vent plug.
4. Select required lever size (1) M, L or XL and pin position according to the actuator size and valve travel listed in the travel table on page 5-4.

If a pin position other than position 35 with the standard M lever is required or an L or XL lever size is required. Proceed as described in Chapter 5.3.

5. Insert the molded seal (6.2) in the groove of the adapter bracket.
6. Insert the molded seal (17.1) into the turnboard (17) and mount the turnboard to the adapter block (13) using the screws (17.2).

Installation

7. Mount the blank plate (18) to the turnboard using the screws (18.1). Make sure that the seals are correctly seated.

i Note

A solenoid valve can also be mounted in place of the blank plate (18). The orientation of the turnboard (17) determines the mounting position of the solenoid valve. Alternatively, a restrictor plate can be mounted (▶ AB 11).

8. Fasten the adapter block (13) to the NAMUR connection block using the screws (13.1).
9. Insert the vent plug into the Exh. connection.
10. Place the positioner on the adapter block (13) in such a way that the follower pin (2) rests on the top of the follower plate (3, 3.1). Adjust the lever (1) correspondingly.
Fasten the positioner to the adapter block (13) using the two fastening screws (6.3). Make sure the molded seal (6.2) is properly seated.
11. For **single-acting actuators without air purging**, connect the Y1 port of the adapter block to the signal pressure connection of the actuator. Seal the Y2 port with a blanking plug.

For **double-acting actuators and actuators with air purging**, connect the Y2 port of the adapter block to the signal pressure connection of the second actuator chamber or spring chamber of the actuator.

5.4.4 Attachment according to VDI/VDE 3847-2

Attachment according to VDI/VDE 3847-2 for PFEIFFER SRP (single-acting) and DAP (double-acting) rotary actuators in sizes 60 to 1200 with NAMUR interface and air purging of the actuator's spring chamber allows the direct attachment of the positioner without additional piping.

Additionally, the positioner can be replaced quickly while the process is running by blocking the air in single-acting actuators.

Procedure to block the actuator in place (see Fig. 5-11):

1. Unscrew the red retaining screw (1).
2. Turn the air blocker (2) on the bottom of the adapter block according to the inscription.

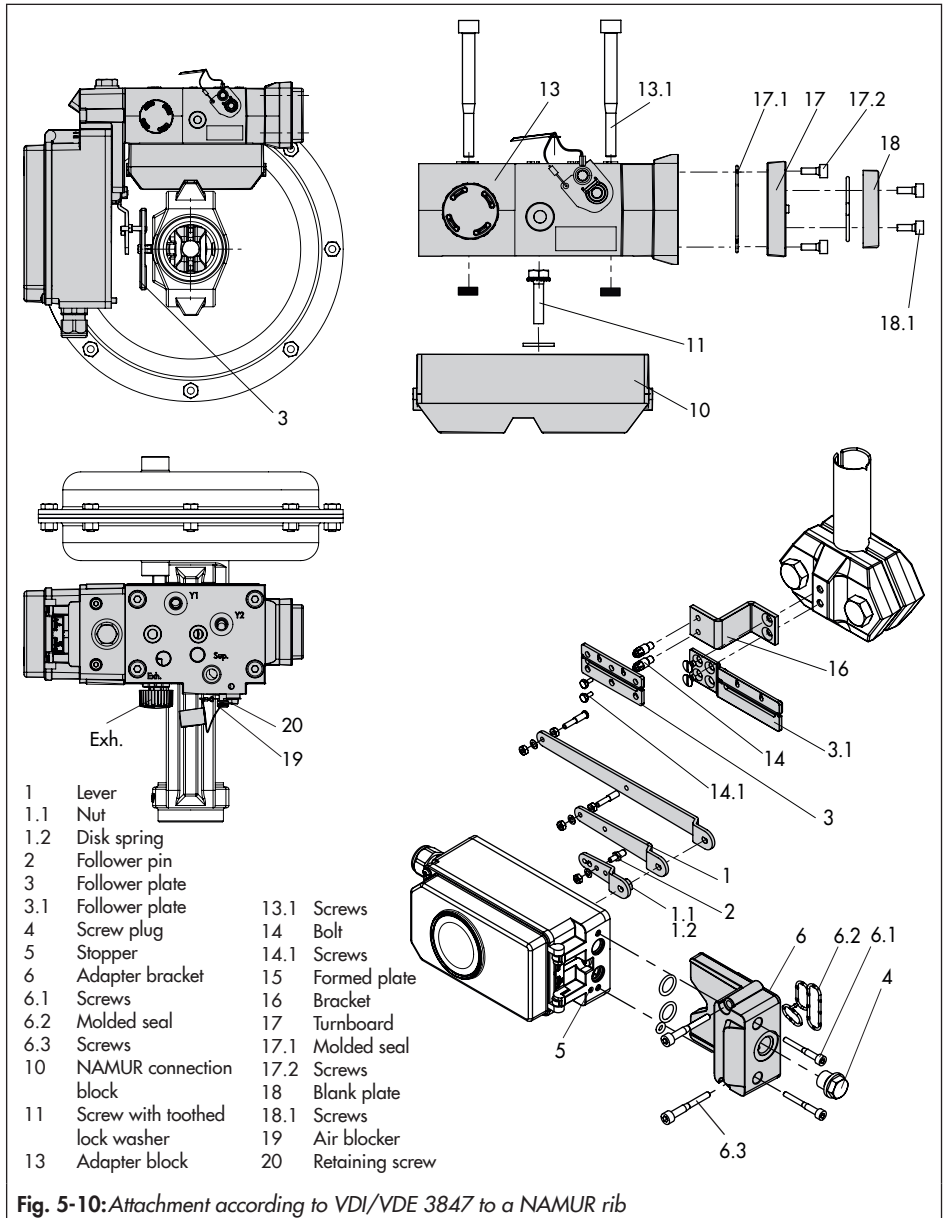

a) Version for single-acting actuator

Mounting onto a PFEIFFER Type 31a (edition 2020+) SRP Rotary Actuator

→ See Fig. 5-13

1. Fasten the adapter block (1) to the actuator's NAMUR interface using the four fastening screws (2).
 - Make sure that the seals are correctly seated.
2. Mount the follower wheel (3) onto the actuator shaft. Use the matching shaft adapter (see Table 5-9).
3. Place the adapter bracket (4) onto the adapter block (1) and fasten it using the fastening screws (5).
 - Make sure that the seals are correctly seated.
4. Insert and fasten the follower pin in the 90° position on the positioner's lever (see Fig. 5-12).
 - Only use the longer follower pin included in the mounting kit.
5. Align the positioner on the adapter bracket (1) in such a way that the follower pin engages into the actuator's follower wheel (3).
6. Fasten the positioner onto the adapter bracket (4) using the fastening screws (6).
 - Make sure that the seals are correctly seated.

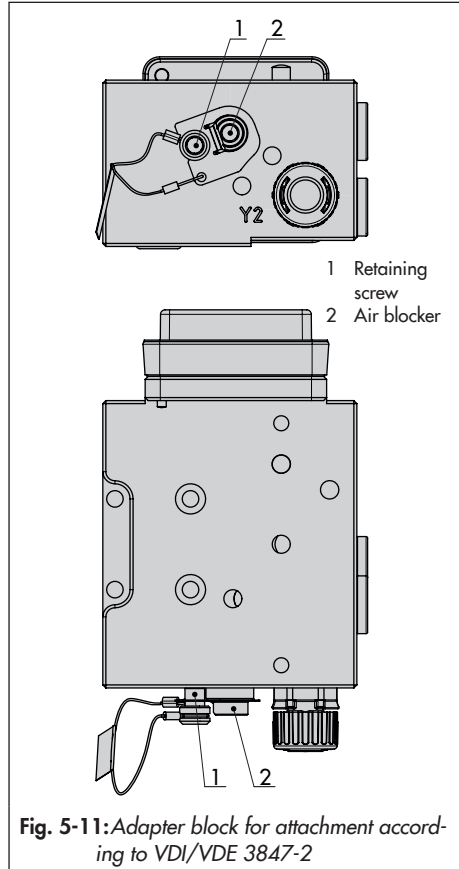

Fig. 5-11: Adapter block for attachment according to VDI/VDE 3847-2

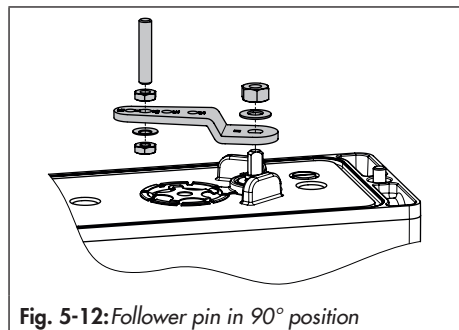
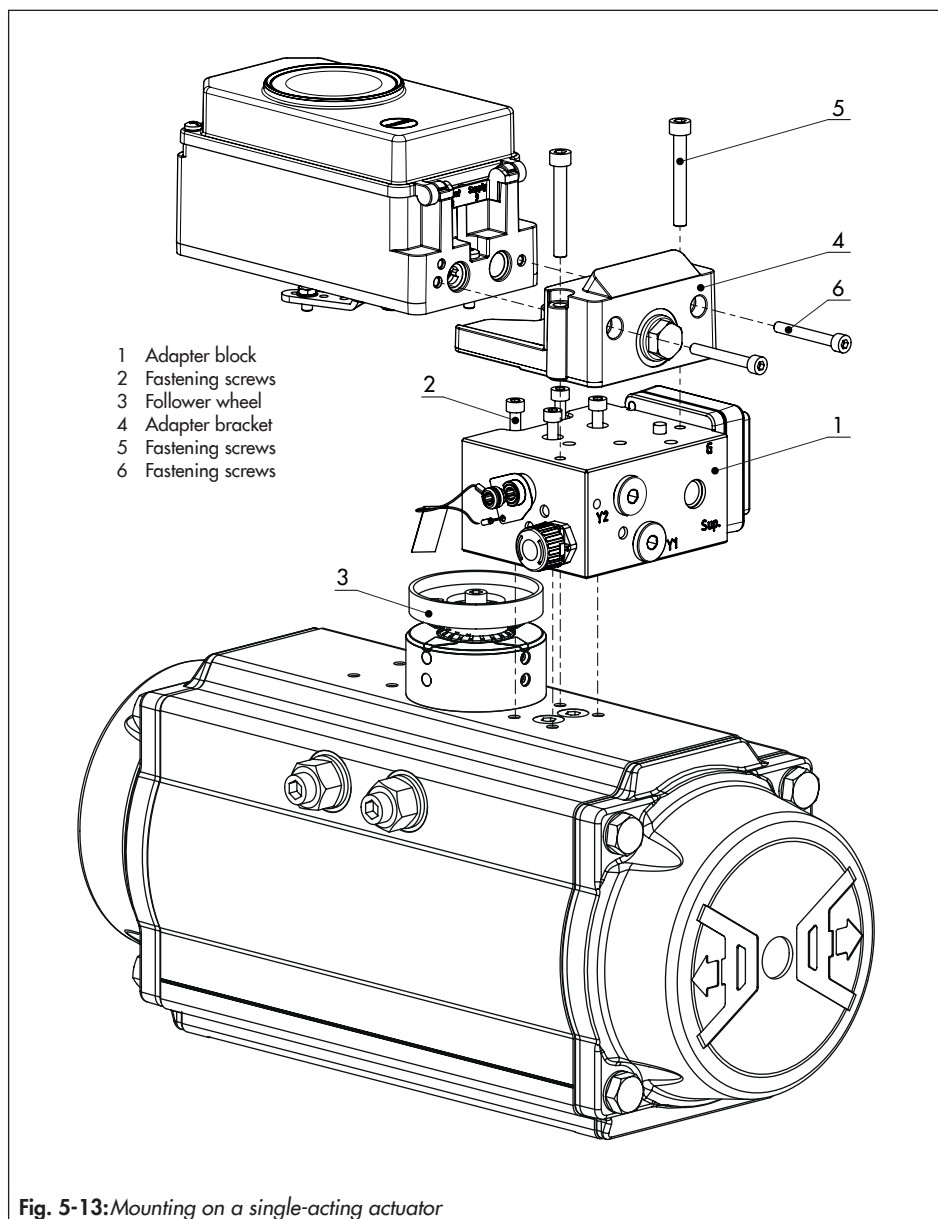

Fig. 5-12: Follower pin in 90° position



b) Version for double-acting actuator

A reversing amplifier must be additionally mounted for applications with double-acting (DAP) actuators or applications with single-acting (SAP) actuators that include partial stroke testing.

In this case, a special adapter bracket (4) is required for mounting.

→ See Fig. 5-15

1. Fasten the adapter block (1) to the actuator's NAMUR interface using the four fastening screws (2).
→ Make sure that the seals are correctly seated.
2. Mount the follower wheel (3) onto the actuator shaft. Use the matching adapter (see Table 5-9).
3. Place the adapter bracket (4) onto the adapter block (1) and fasten it using the fastening screws (5).
→ Make sure that the seals are correctly seated.
4. Insert and fasten the follower pin in the 90° position on the positioner's lever (see Fig. 5-12).
5. Align the positioner on the adapter bracket (1) in such a way that the follower pin engages into the actuator's follower wheel (3).
6. Fasten the positioner onto the adapter bracket (4) using the fastening screws (6).

7. Mount the Type 3710 Reversing Amplifier (7) together with the two guide bushings (8) and terminal plate (9) onto the adapter bracket using the associated fastening screws (10).
→ Make sure that the seals are correctly seated.
8. Remove the vent plug at the adapter block and seal the opening with the G 1/4 screw plug.
9. Mount the turnboard marked '**Doppel**' for double-acting actuators or the turnboard marked '**PST**' for single-acting actuators with partial stroke testing. See Fig. 5-14.
→ Make sure that the seals are correctly seated.

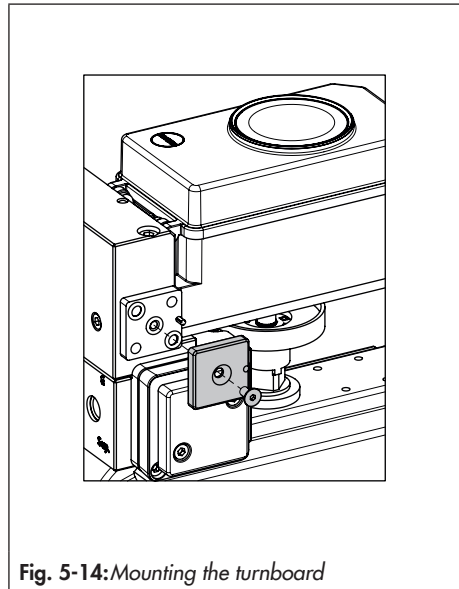
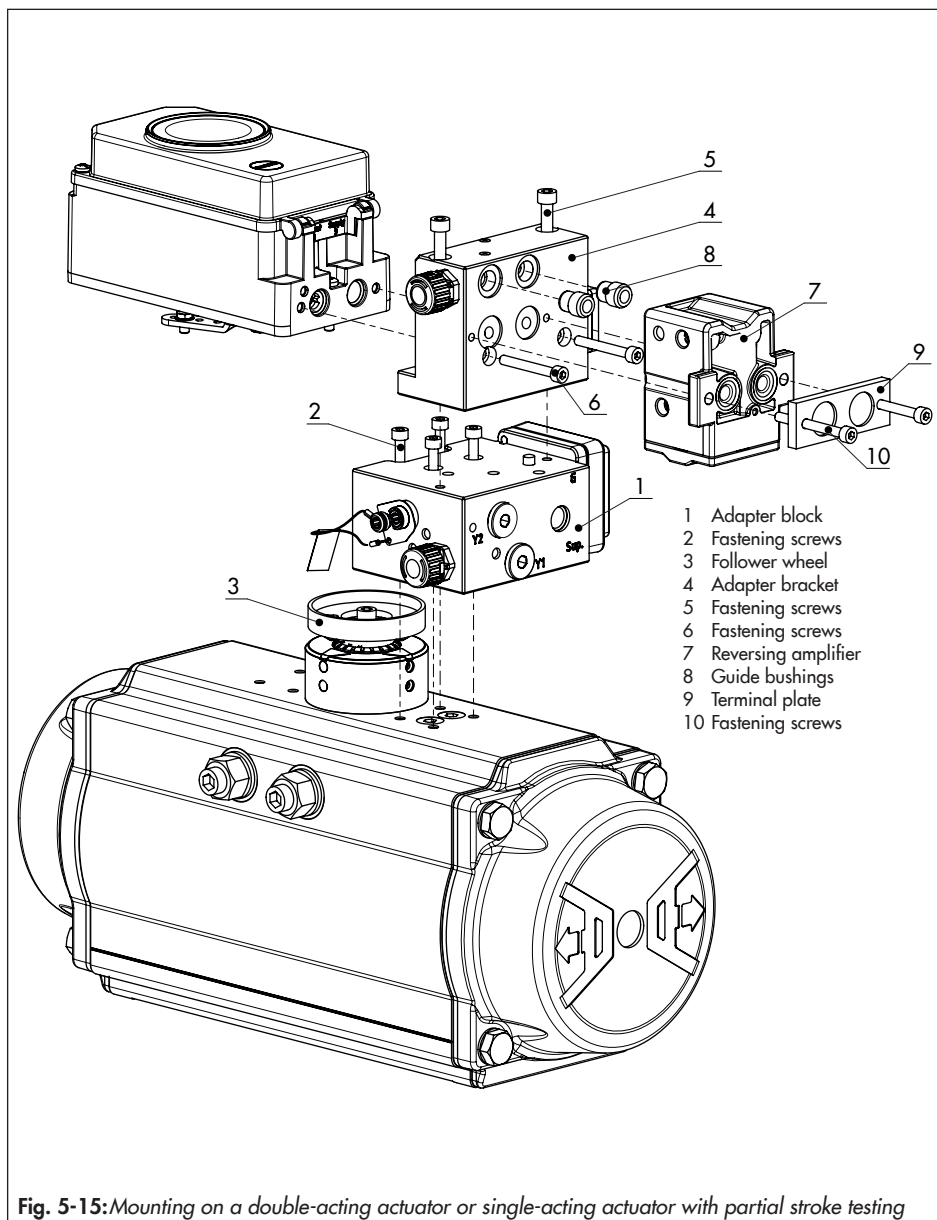

Fig. 5-14: Mounting the turnboard



Intermediate plate for AA4 interface

→ Refer to Fig. 5-16

An intermediate plate (1) must be mounted between the adapter block and adapter bracket for PFEIFFER SRP and DAP rotary actuators in sizes 900 and 1200 with AA4 interface. This plate is included in the accessories for the shaft adapter AA4 (see Table 5-9).

Mounting a solenoid valve

→ Refer to Fig. 5-17

A solenoid valve (13) can also be mounted in place of the blank plate (12). The orientation of the turnboard (14) determines the mounting position of the solenoid valve. Alternatively, a restrictor plate can be mounted. Further information can be found in the document ► AB 11 (Accessories for Solenoid Valves).

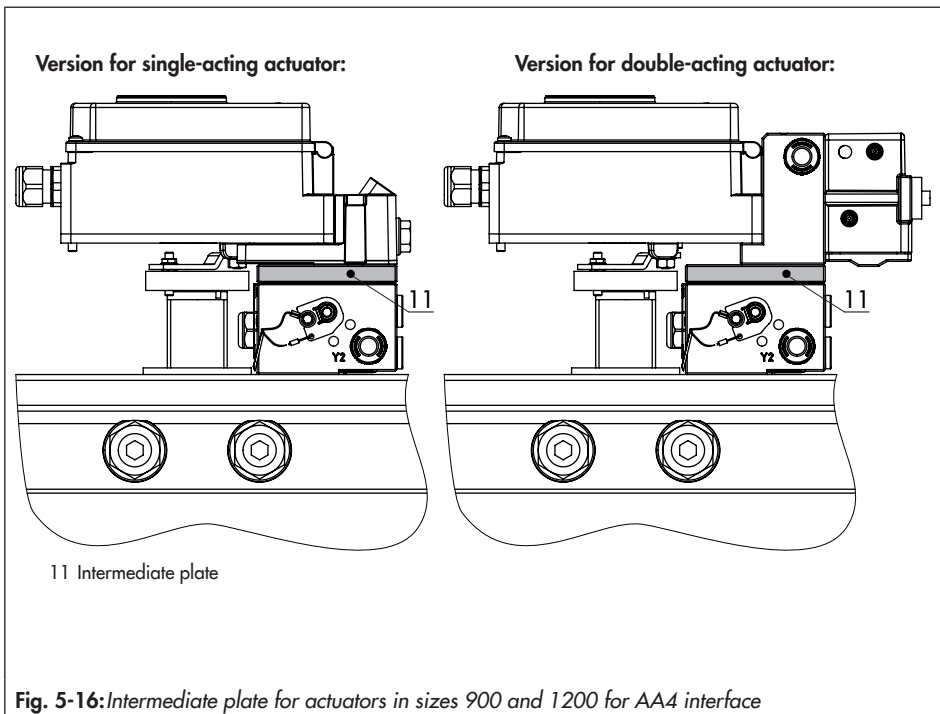

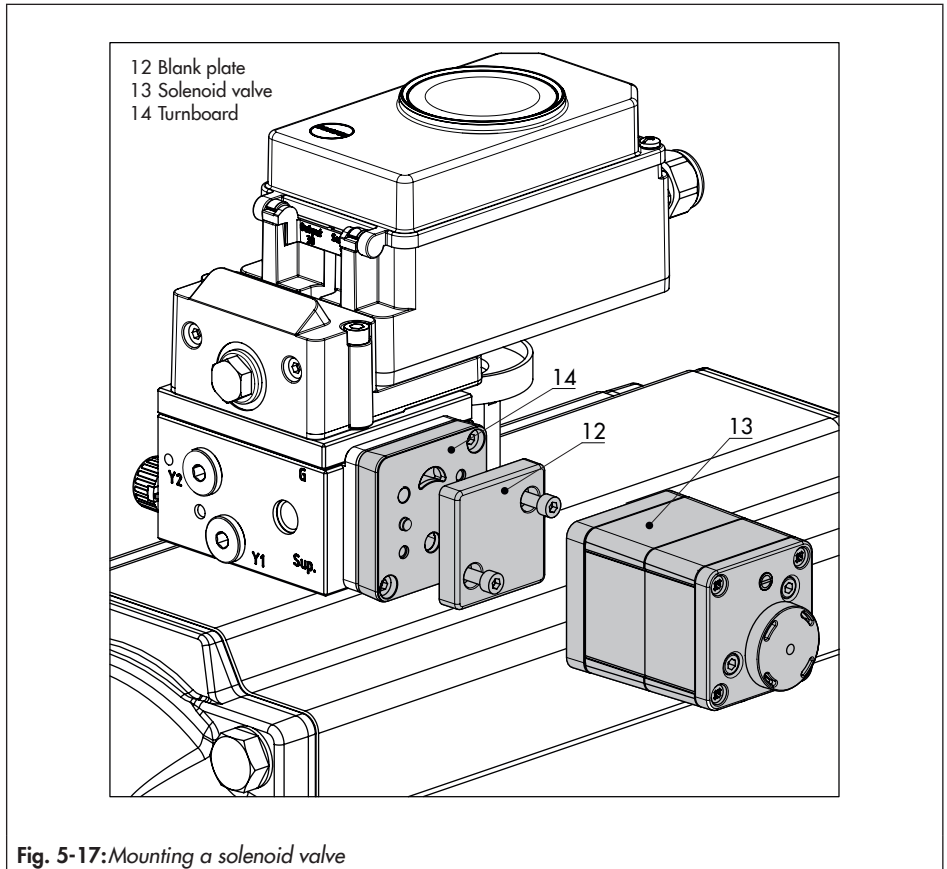

Fig. 5-17: Mounting a solenoid valve

5.4.5 Attachment to Type 3510 Micro-flow Valve

- ➔ Refer to Fig. 5-18
- ➔ Required mounting parts and accessories: Table 5-7
- ➔ Observe the travel table on page 5-4.

The positioner is attached to the valve yoke using a bracket.

1. Fasten the bracket (9.1) to the stem connector.
2. Screw the two bolts (9.2) to the bracket (9.1) of the stem connector (9), place the follower plate (3) on top and use the screws (9.3) for fastening.
3. Mount the travel indication scale (accessories) to the outer side of the yoke using the hex screws (12.1), ensuring that the scale is aligned with the stem connector.
4. Fasten the hex bar (11) onto the outer side of yoke by screwing the M8 screws (11.1) directly into the holes on the yoke.
5. Fasten the bracket (10) to the hex bar (11) using the hex screw (10.1), shim and tooth lock washer.
6. Mount connecting plate (6) or pressure gauge bracket (7) with pressure gauges on the positioner, making sure the two seals are seated properly.
7. Unscrew the standard M lever (1) including follower pin (2) from the positioner shaft.

8. Take the S lever (1) and screw the follower pin (2) in the hole for pin position 17. Proceed as described as in Chapter 5.3.
9. Place positioner on the bracket (10) in such a way that the follower pin slides into the groove of the follower pin (3). Adjust the lever (1) correspondingly. Screw the positioner to the bracket (10) using both its screws.

5.4.6 Attachment to rotary actuators

- ➔ See Fig. 5-20
- ➔ Required mounting parts and accessories: Table 5-10
- ➔ Observe the travel table on page 5-4.

The positioner is mounted to the rotary actuator using two pairs of brackets.

Prior to attaching the positioner to the SAMSON Type 3278 Rotary Actuator, mount the associated adapter (5) to the free end of the rotary actuator shaft.

i Note

When attaching the positioner as described below, it is important that the actuator's direction of rotation is observed.

1. Place follower clamp (3) on the slotted actuator shaft or adapter (5).

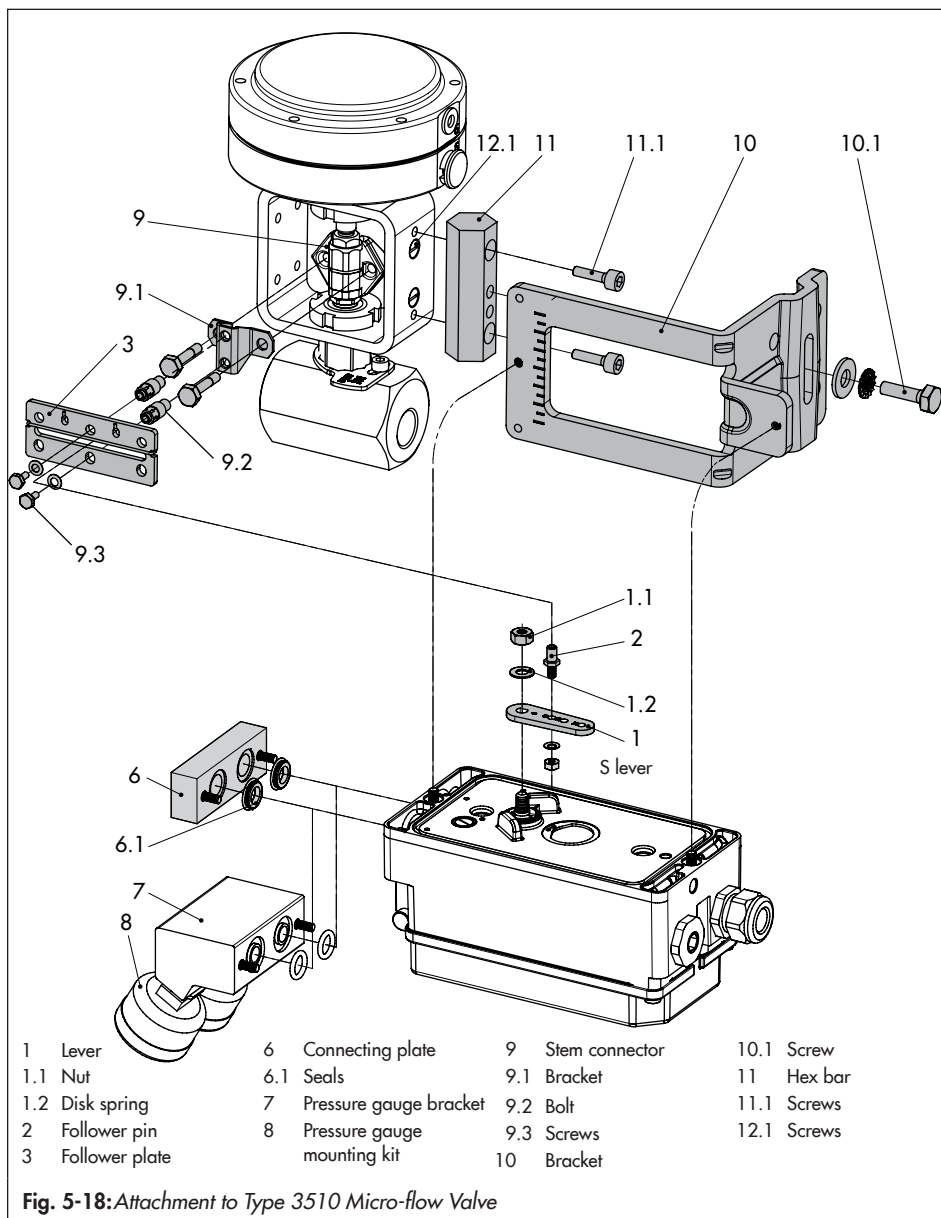

Installation

- Place coupling wheel (4) with flat side facing the actuator on the follower clamp (3). Refer to Fig. 5-20 to align slot so that it matches the direction of rotation when the valve is in its closed position.
- Fasten the coupling wheel (4) and follower clamp (3) tightly onto the actuator shaft using screw (4.1) and disk spring (4.2).
- Fasten the bottom pair of brackets (10.1) with the bends pointing either facing to the inside or to the outside (depending on the actuator size) onto the actuator housing. Position the top pair of brackets (10) and fasten.
- Mount connecting plate (6) or pressure gauge bracket (7) with pressure gauges on the positioner, making sure the two seals are seated properly. Double-acting springless rotary actuators require the use of a reversing amplifier on the connection side of the positioner housing (see Chapter 5.4.7).
- Unscrew the standard follower pin (2) from the positioner's M lever (1). Use the metal follower pin (\varnothing 5 mm) included in the mounting kit and screw tight into the hole for pin position 90°.
- Place positioner on the top bracket (10) and fasten tight. Taking the actuator's direction of rotation into account, adjust lever (1) so that it engages in the slot of the coupling wheel (4) with its follower pin (Fig. 5-20). It must be guaranteed that the lever (1) is parallel to the long side of the positioner when the actuator is at half its angle of rotation.
- Stick the scale plate (4.3) on the coupling wheel so that the arrow tip indicates the closed position and it can be easily read when the valve is installed.

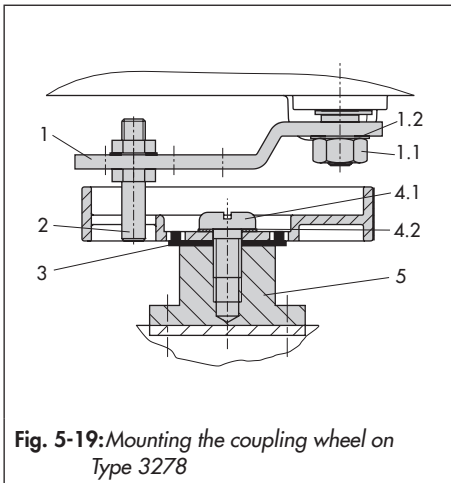

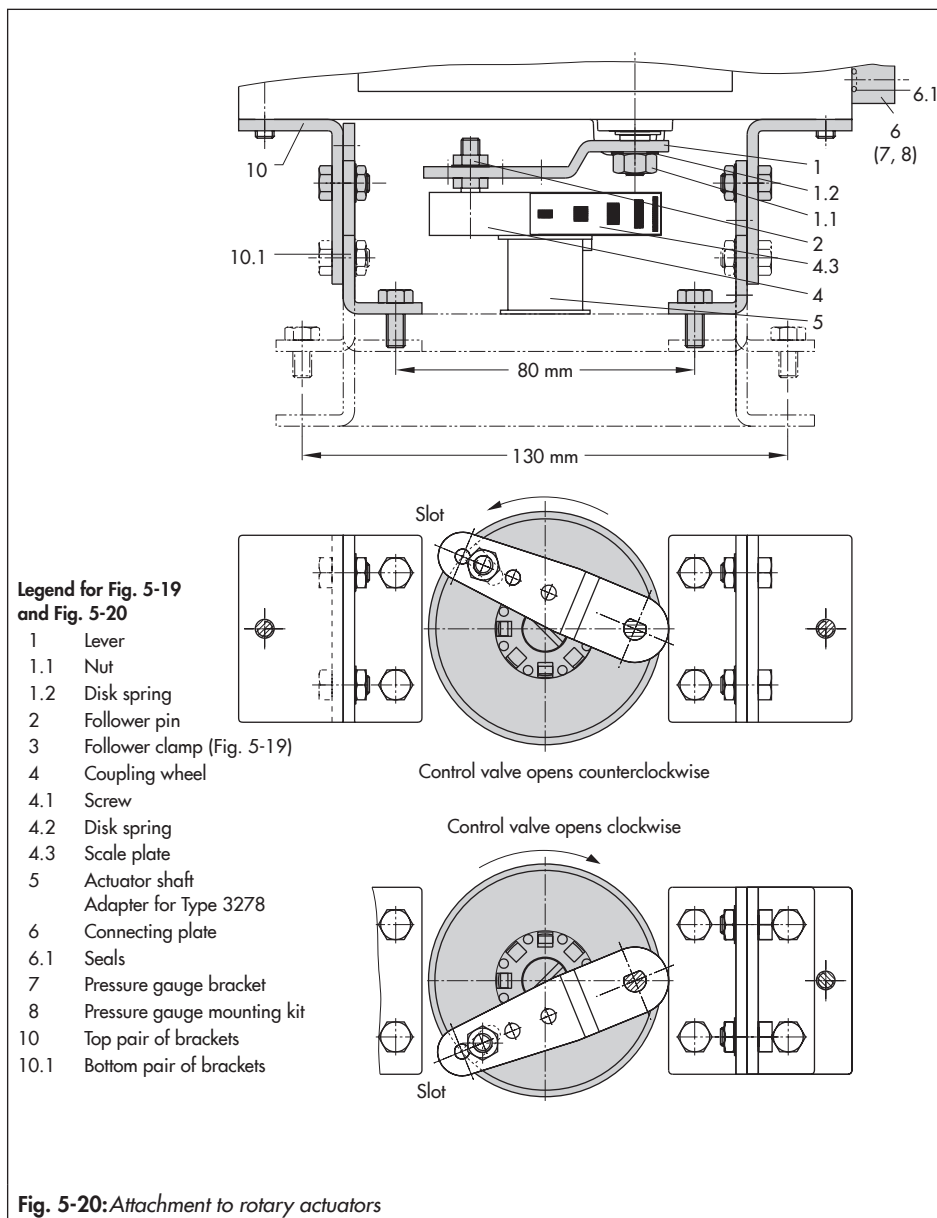

a) Heavy-duty version

→ See Fig. 5-22

→ Required mounting parts and accessories: Table 5-10

Both mounting kits contain all the necessary mounting parts. The parts for the actuator size used must be selected from the mounting kit.

Prepare actuator and mount possibly required adapter supplied by the actuator manufacturer.

1. Mount the housing (10) onto the rotary actuator. In case of VDI/VDE attachment, place spacers (11) underneath, if necessary.
2. For **SAMSON Type 3278 and VETEC S160 Rotary Actuators**, fasten the adapter (5) onto the free end of the shaft and for **VETEC R Actuator**, place on the adapter (5.1). For **Type 3278, VETEC S160 and VETEC R Actuators**, place on the adapter (3). For VDI/VDE

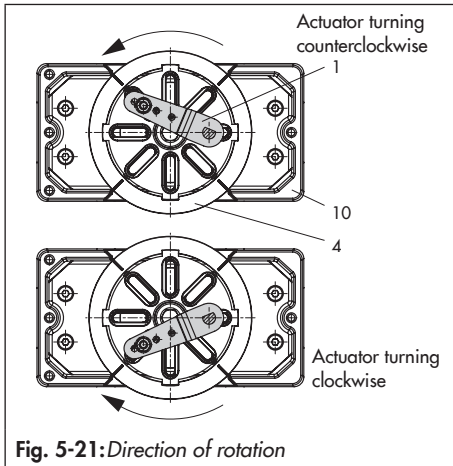
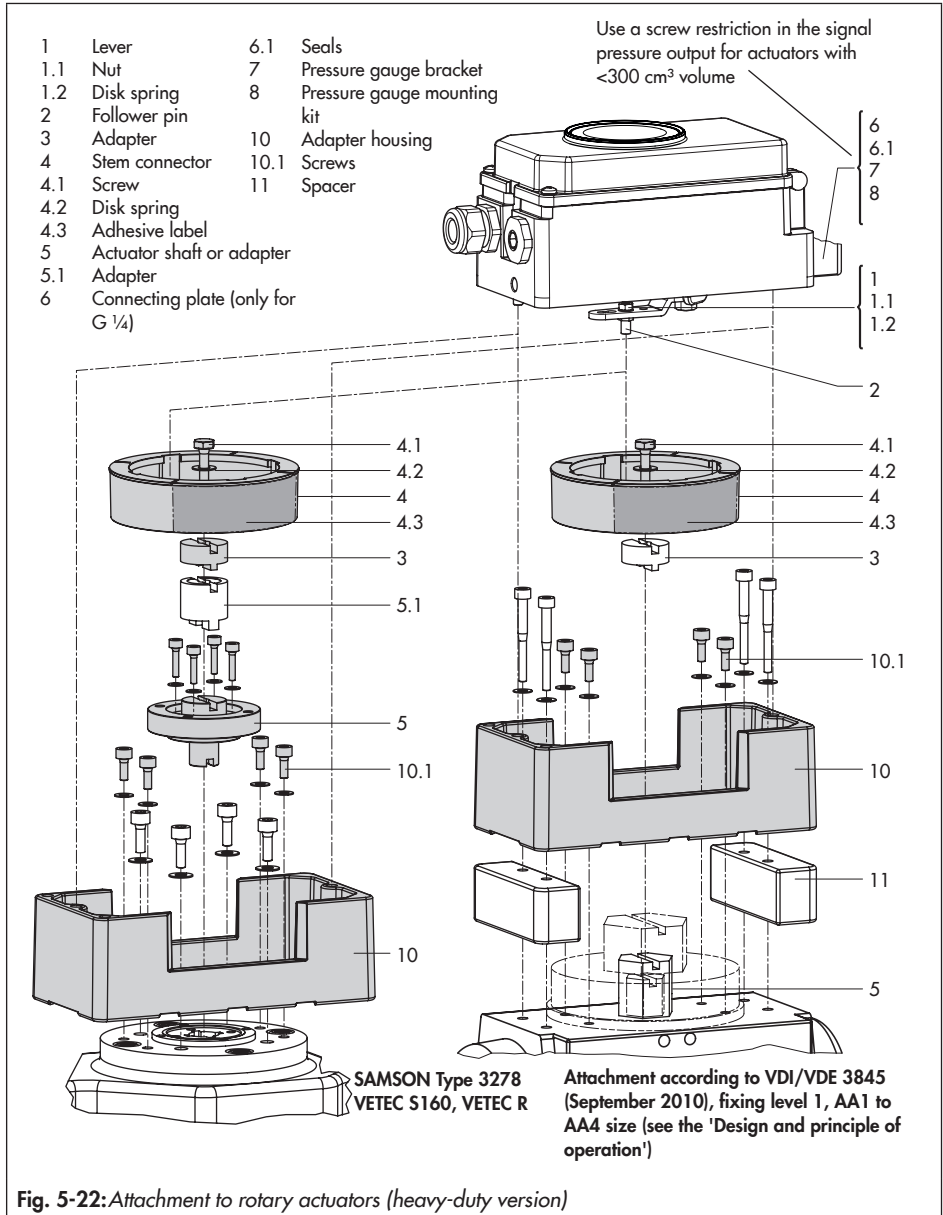

Fig. 5-21: Direction of rotation

version, this step depends on the actuator size.

3. Stick adhesive label (4.3) onto the coupling in such a way that the yellow part of the sticker is visible in the window of the housing when the valve is OPEN. Adhesive labels with explanatory symbols are enclosed and can be stuck on the housing, if required.
4. Fasten coupling wheel (4) on the slotted actuator shaft or adapter (3) using screw (4.1) and disk spring (4.2).
5. Unscrew the standard follower pin (2) from the positioner's M lever (1). Attach the follower pin (Ø5 mm) included in the mounting kit to pin position 90°. Proceed as described in Chapter 5.3.
6. Mount connecting plate (6) for required G ¼ connecting thread or pressure gauge bracket (7) with pressure gauges on the positioner, making sure the two seals (6.1) are seated properly. Double-acting springless rotary actuators require the use of a reversing amplifier on the connection side of the positioner housing (see Chapter 5.4.7).
7. For actuators with a volume of less than 300 cm³, screw the screw restriction (order no. 1400-6964) into the signal pressure output of the positioner (or the output of the pressure gauge bracket or connecting plate).
8. Place positioner on housing (10) and screw it tight. Taking the actuator's direction of rotation into account, adjust lever (1) so that it engages in the correct slot with its follower pin (Fig. 5-21).



5.4.7 Reversing amplifier for double-acting actuators

For the use with double-acting actuators, the positioner must be fitted with a reversing amplifier, e.g. the SAMSON Type 3710 Reversing Amplifier (see Mounting and Operating Instructions ► EB 8392).

The following applies to all reversing amplifiers:

The signal pressure of the positioner is supplied at the output 1 of the reversing amplifier. An opposing pressure, which equals the required supply pressure (Z) when added to the pressure at output 1, is applied at output 2.

The following relationship applies:

output 1 + output 2 = Supply pressure (Z).

Connect output 1 to the signal pressure connection on the actuator that causes the valve to open when the pressure rises.

Connect output 2 to the signal pressure connection on the actuator that causes the valve to close when the pressure rises.

- ➔ Set slide switch on positioner to AIR TO OPEN.

i Note

How the outputs are marked depends on the reversing amplifier used. **Type 3710:** Output 1/2 = Y_1/Y_2

5.5 Mounting the external position sensor

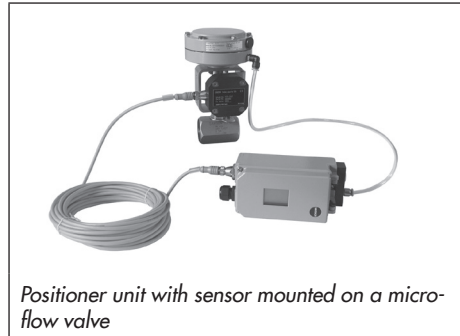

Positioner unit with sensor mounted on a micro-flow valve

- ➔ Required mounting parts and accessories: Table 5-11

In the positioner version with an external position sensor, the sensor located in a separate housing is attached over a plate or bracket to the control valve. The travel pick-off corresponds to that of a standard device.

The positioner can be mounted as required to a wall or a pipe.

For the pneumatic connection either a connecting plate (6) or a pressure gauge bracket (7) must be fixed to the housing, depending on the accessory chosen. Make sure the seals (6.1) are correctly inserted (see Fig. 5-7, bottom right).

For the electrical connection a 10 m connecting lead with M12x1 connectors is included in the scope of delivery.

i Note

- In addition, the instructions in Chapters 5.10 and 5.11 apply for the pneumatic and electrical connection.

Operation and setting are described in the 'Start-up and configuration' chapter.

- Since 2009, the back of the position sensor (20) is fitted with two pins acting as mechanical stops for the lever (1). If this position sensor is mounted using old mounting parts, two corresponding $\varnothing 8$ mm holes must be drilled into the mounting plate/bracket (21). A template is available for this purpose. See Table 5-11.

5.5.1 Mounting the position sensor with direct attachment

Type 3277-5 Actuator with 120 cm² (Fig. 5-23)

The signal pressure from the positioner is routed over the signal pressure connection of the connecting plate (9, Fig. 5-23 left) to the actuator diaphragm chamber. To proceed, first screw the connecting plate (9) included in the accessories onto the actuator yoke.

- Turn the connecting plate (9) so that the correct symbol for the fail-safe action "actuator stem extends" or "actuator stem retracts" is aligned with the marking (see Fig. 5-23, bottom).
 - ➔ Make sure that the gasket for the connecting plate (9) is correctly inserted.
- The connecting plate has threaded holes with NPT and G threads. Seal the threaded connection that is not used with the rubber seal and square plug.

Type 3277 Actuator with 175 to 750 cm²:

The signal pressure is routed to the connection at the side of the actuator yoke for the version with fail-safe action "actuator stem extends". For the fail-safe action "actuator stem retracts" the connection on the top diaphragm case is used. The connection at the side of the yoke must be fitted with a venting plug (accessories).

Mounting the position sensor

1. Place the lever (1) on the sensor in mid-position and hold it in place. Unthread the nut (1.1) and remove the lever together with the disk spring (1.2) from the sensor shaft.
2. Screw the position sensor (20) onto the mounting plate (21).
3. Depending on the actuator size and rated valve travel, determine which lever and position of the follower pin (2) is to be used from the travel table on page 5-4. The positioner is delivered with the **M** lever in pin position 35 on the sensor. If necessary, remove the follower pin (2) from its pin position and move it to the hole for the recommended pin position and screw tight.
4. Place the lever (1) and disk spring (1.2) on the sensor shaft. Place the lever **in mid-position** and **hold it in place**. Screw on the nut (1.1).
5. Place follower clamp (3) on the actuator stem, align it and screw tight so that the mounting screw is located in the groove of the actuator stem.

6. Place the mounting plate together with the sensor onto the actuator yoke so that the follower pin (2) rests on the top of the follower clamp (3). It must rest on it with spring force. Fasten the mounting plate (21) onto the actuator yoke using both fixing screws.
7. Mount cover (11) on the other side.
 - ➔ Make sure that the vent plug is located at the bottom when the control valve is installed to allow any condensed water that collects to drain off.

5.5.2 Mounting the position sensor with attachment according to IEC 60534-6 (NAMUR)

- ➔ See Fig. 5-24
 - ➔ Required mounting parts and accessories: Table 5-11
1. Place the lever (1) on the position sensor in **mid-position** and **hold it in place**. Unthread the nut (1.1) and remove the lever together with the disk spring (1.2) from the sensor shaft.

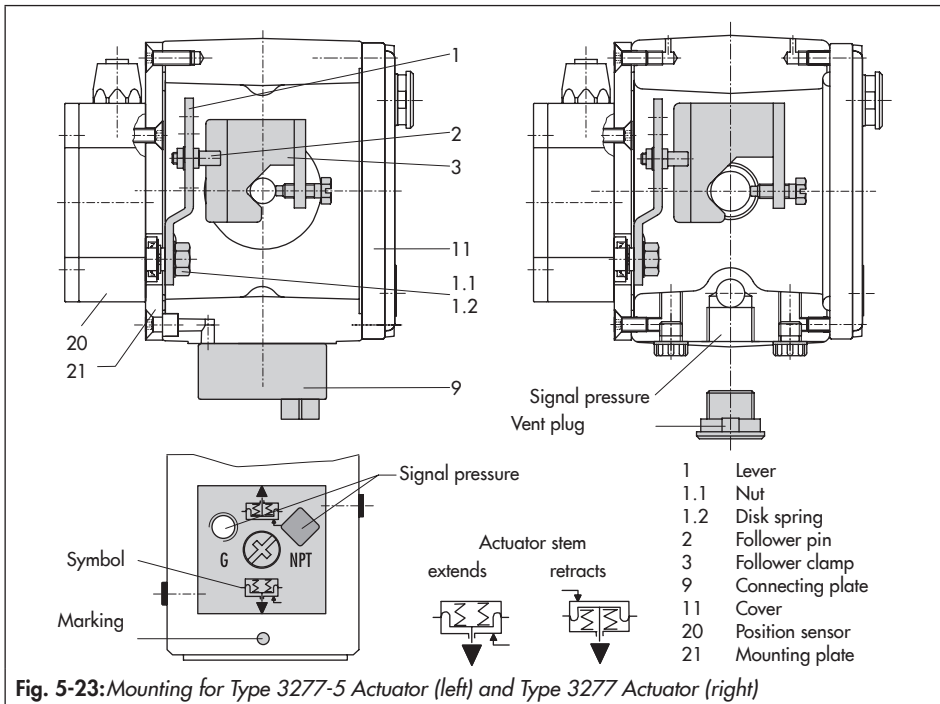

Fig. 5-23: Mounting for Type 3277-5 Actuator (left) and Type 3277 Actuator (right)

2. Screw the position sensor (20) onto the bracket (21).

The standard attached M lever with the follower pin (2) at position 35 is designed for 120 to 350 cm² actuators with 15 mm rated travel. For other actuator sizes or travels, select the lever and pin position from the travel table on page 5-4. L and XL levers are included in the mounting kit.

3. Place the lever (1) and disk spring (1.2) on the sensor shaft. Place the lever in **mid-position** and **hold it in place**. Screw on the nut (1.1).

4. Screw the two bolts (14) to the bracket (9.1) of the stem connector (9), place the follower plate (3) on top and use the screws (14.1) for fastening.
5. Place the bracket with the sensor at the NAMUR rib in such a way that the follower pin (2) rests in the slot of the follower plate (3), then screw the bracket using its fixing screws onto the valve.

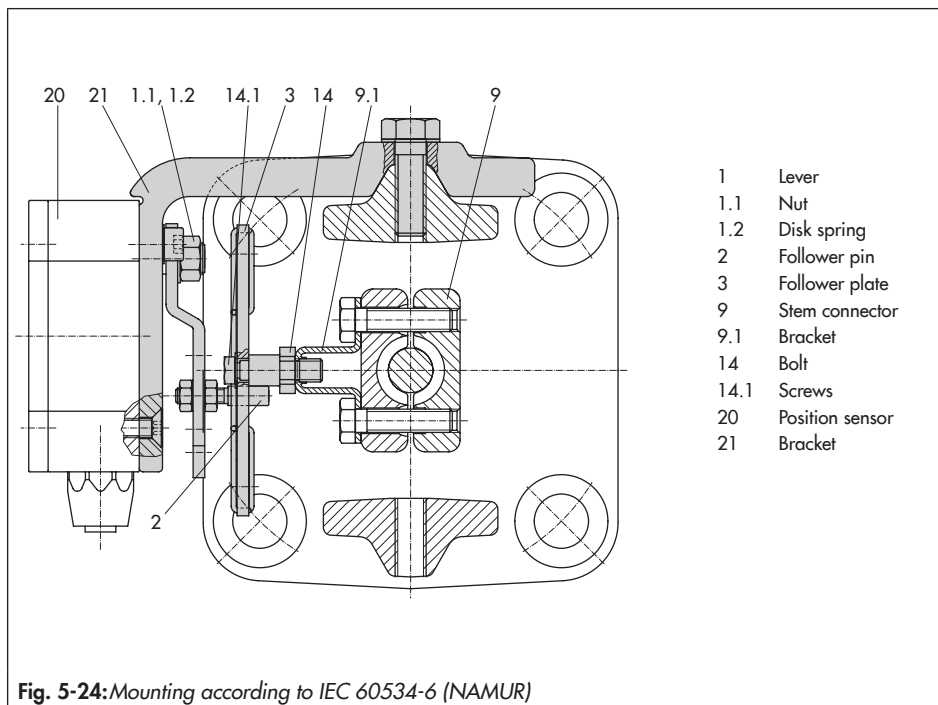

- | | |
|------|-----------------|
| 1 | Lever |
| 1.1 | Nut |
| 1.2 | Disk spring |
| 2 | Follower pin |
| 3 | Follower plate |
| 9 | Stem connector |
| 9.1 | Bracket |
| 14 | Bolt |
| 14.1 | Screws |
| 20 | Position sensor |
| 21 | Bracket |

5.5.3 Mounting the position sensor on a Type 3510 Micro-flow Valve

→ See Fig. 5-25

→ Required mounting parts and accessories: Table 5-11

1. Place the lever (1) on the position sensor in **mid-position** and **hold it in place**. Unscrew the nut (1.1) and remove the standard attached M lever (1) together with the disk spring (1.2) from the sensor shaft.
2. Screw position sensor (20) onto the bracket (21).
3. Select the S lever (1) from the accessories and screw the follower pin (2) into the hole for pin position 17. Place the lever (1) and disk spring (1.2) on the sensor shaft. Place the lever in mid-position and hold it in place. Screw on the nut (1.1).
4. Place follower clamp (3) on the valve stem connector, align at a right angle and screw tight.
5. Position the bracket (21) with the position sensor on the valve yoke and screw tight, making sure the follower pin (2) slides into the groove of the follower clamp (3).

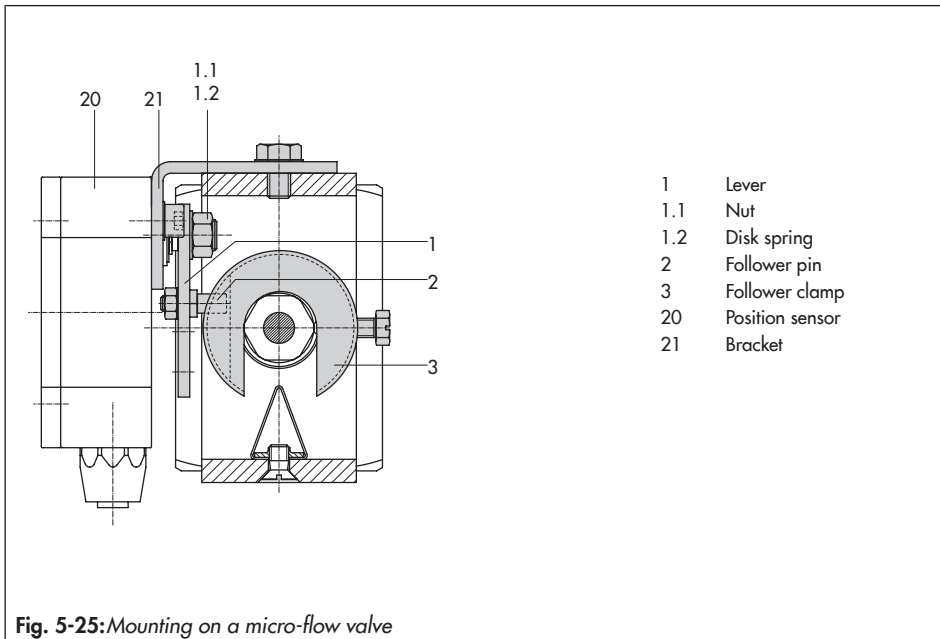

5.5.4 Mounting on rotary actuators

→ See Fig. 5-26

→ Required mounting parts and accessories: Table 5-11

1. Place the lever (1) on the position sensor in **mid-position** and **hold it in place**. Unthread the nut (1.1) and remove the lever together with the disk spring (1.2) from the sensor shaft.
2. Screw the position sensor (20) onto the mounting plate (21).

3. Replace the follower pin (2) normally attached to the lever (1) with the metal follower pin ($\varnothing 5$ mm) from the accessories and screw it into the hole for pin position 90° .
4. Place the lever (1) and disk spring (1.2) on the sensor shaft. Place the lever in **mid-position** and **hold it in place**. Screw on the nut (1.1).

Follow the instructions describing attachment to the standard positioner in Chapter 5.4.6.

Instead of the positioner, attach the position sensor (20) with its mounting plate (21).

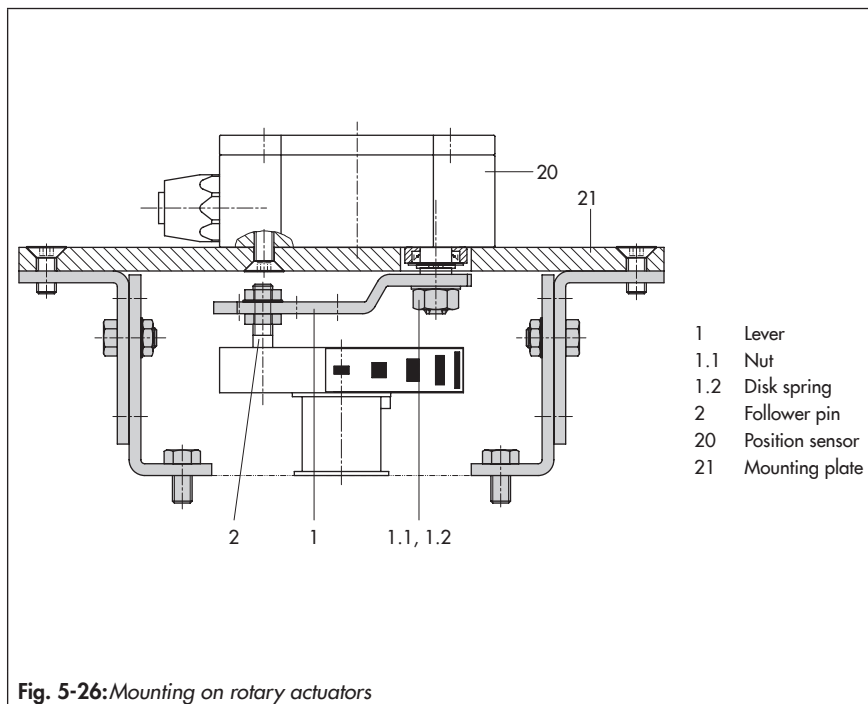

5.6 Mounting the leakage sensor

→ See Fig. 5-27

Normally, the control valve is delivered with positioner and leakage sensor already mounted.

If the leakage sensor is mounted after the valve has been installed or it is mounted on another control valve, proceed as described in the following.

! NOTICE

Risk of malfunction due to incorrect fastening.

Fasten the leakage sensor using a torque of 20 ± 5 Nm.

The M8 threaded connection on the NAMUR rib should preferably be used to mount the sensor (Fig. 5-27).

💡 Tip

If the positioner was mounted directly onto the actuator (integral attachment), the NAMUR interfaces on either side of the valve yoke can be used to mount the leakage sensor.

The start-up of the leakage sensor is described in detail in the Operating Instructions for EXPERTplus Valve Diagnostics.

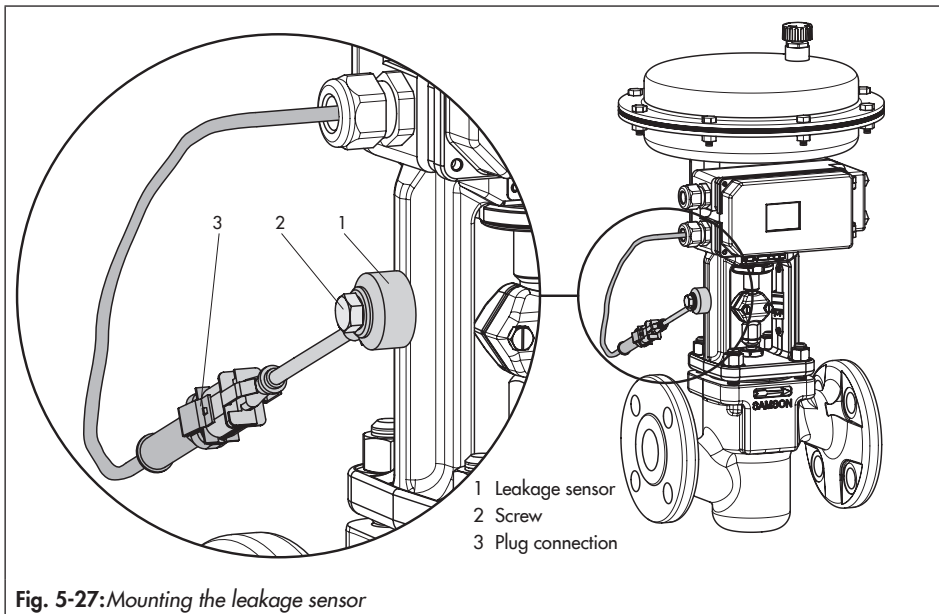

Fig. 5-27: Mounting the leakage sensor

5.7 Retrofitting inductive limit switch

Required retrofit kit:

Limit switch Order no. 1402-1770

i Note

The same requirements apply to retrofitting a unit as to servicing the positioner. For explosion-protected positioners, the requirements specified under 'Servicing explosion-protected devices' in the 'Safety instructions and measures' chapter must be observed. Check the "Limit switch, inductive" box on the nameplate after installing the limit switch.

1. Remove rotary pushbutton (3) and cap (1), unthread the five fastening screws (2) and lift off the plastic cover (9) together with the display, taking care not to damage the ribbon cable (between PCB and display).
2. Use a knife to cut an opening at the marked location (4).
3. Push connector (11) with cable through the opening and secure the proximity switch (7) on the cover with a dot of glue.
4. Remove the jumper (8801-2267) at the socket X7 of the top board and insert the cable connector (11).
5. Guide the cable in such a way that the plastic cover can be placed back onto the positioner. Insert the fixing screws (2) and screw tight. Attach the clamping plate (8) onto the proximity switch.

6. Attach the rotary switch (5). Make sure the flattened side of the positioner shaft is turned so that the rotary switch (5) can be attached with the metal tag next to the proximity switch.
7. On start-up of the positioner, set the option inductive alarm under Code 38 from No to YES.

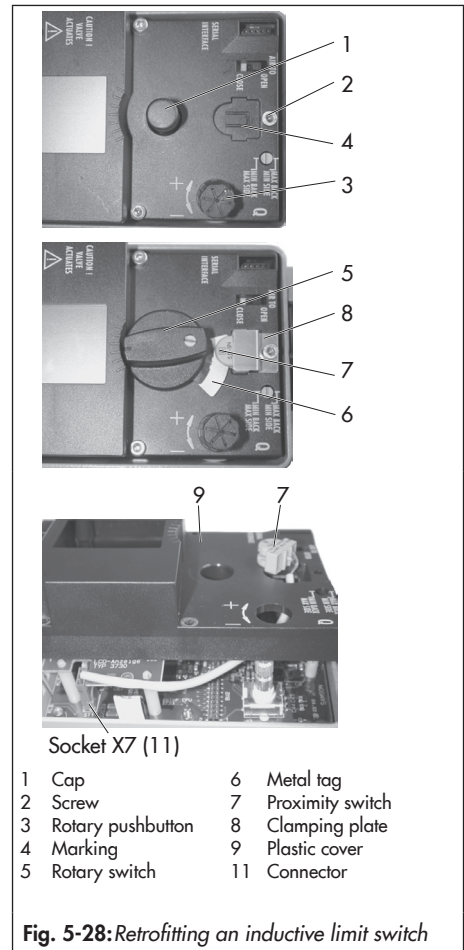

Fig. 5-28: Retrofitting an inductive limit switch

5.8 Mounting positioners with stainless steel housings

Positioners with stainless steel housings require mounting parts that are completely made of stainless steel or free of aluminum.

i Note

The pneumatic connecting plate and pressure gauge bracket are available in stainless steel (order numbers listed below). The Type 3710 Pneumatic Reversing Amplifier is also available in stainless steel.

Connecting plate (stainless steel)	G 1/4 1/4 NPT	1400-7476 1400-7477
Pressure gauge bracket (stainless steel)	G 1/4 1/4 NPT	1402-0265 1400-7108

Table 5-4 to Table 5-10 apply for attaching positioners with stainless steel housings with the following restrictions:

Direct attachment

All mounting kits from Table 5-6 can be used. The connection block is not required. The stainless steel version of the pneumatic connecting plate routes the air internally to the actuator.

Attachment according to IEC 60534-6 (NAMUR rib or attachment to rod-type yokes)

All mounting kits from Table 5-7 can be used. Connecting plate in stainless steel.

Attachment to rotary actuators

All mounting kits from Table 5-10 can be used except for the heavy-duty version. Connecting plate in stainless steel.

5.9 Air purging function for single-acting actuators

The instrument air leaving the positioner is diverted to the actuator spring chamber to provide corrosion protection inside the actuator. Observe the following points:

Direct attachment to Type 3277-5 (stem extends FA/stem retracts FE)

The air purging function is automatically provided.

Direct attachment to Type 3277, 175 to 750 cm²

FA: Remove stopper (12.2, Fig. 5-6) at the black connection block and connect the supply to the actuator chamber on the vented side.

! NOTICE

Mounting possibly incorrect when old powder-paint-coated aluminum connection blocks are used.

Mount old powder-paint-coated aluminum connection blocks as described in 'Attachment according to IEC 60534-6 (NAMUR rib or attachment to rod-type yokes)' and 'Attachment to rotary actuators'.

FE: The air purging function is automatically provided.

Attachment according to IEC 60534-6 (NAMUR rib or attachment to rod-type yokes) and to rotary actuators

The positioner requires an additional port for the exhaust air that can be connected over piping. An adapter available as an accessory is used for this purpose:

Threaded bushing	G ¼	0310-2619
(M20x1.5)	¼ NPT	0310-2550

i Note

*The adapter uses one of the M20x1.5 connections in the housing which means **only one** cable gland can be installed.*

If other valve accessories must be used which vent the actuator (e.g. solenoid valve, volume booster, quick exhaust valve), this exhaust air must also be included in the purging function. The connection over the adapter at the positioner must be protected with a check valve (e.g. check valve G ¼, order no. 8502-0597) mounted in the piping. Otherwise the pressure in the positioner housing would rise above the ambient pressure and damage the positioner when the exhausting components respond suddenly.

5.10 Pneumatic connection

⚠ WARNING

Risk of injury by possible movement of exposed parts (positioner, actuator or valve) after connecting the signal pressure.

→ Do not touch or block exposed moving parts.

⚠ NOTICE

Incorrect connection of the supply air will damage the positioner and will lead to malfunction.

→ Screw the screw fittings into the connecting plate, pressure gauge mounting block or connection block from the accessories.

→ Never screw threaded parts directly into the housing.

The pneumatic ports are located on the back of the positioner (see Fig. 5-29).

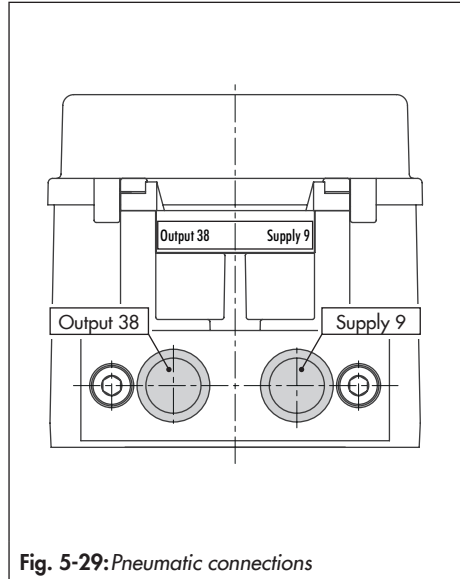

Fig. 5-29: Pneumatic connections

Connecting the supply air

Before performing the pneumatic connection, make sure the following conditions are met:

- The positioner is properly mounted onto the control valve.

If this is the case:

→ Connect the pneumatic connections in the connecting plate, pressure gauge mounting block and connection block (optionally designed as a bore with $\frac{1}{4}$ NPT or G $\frac{1}{4}$ thread). Customary fittings for metal or copper tubing or plastic hoses can be used.

5.10.1 Signal pressure connection

The signal pressure connection depends on how the positioner is mounted onto the actuator:

Type 3277 Actuator

- The signal pressure connection is fixed.

Attachment according to IEC 60534-6 (NAMUR)

- For "actuator stem retracts" fail-safe action: connect the signal pressure to the connection on top of the actuator.
- For "actuator stem extends" fail-safe action: connect the signal pressure to the connection on bottom of the actuator.

Rotary actuators

- For rotary actuators, the manufacturer's specifications for connection apply.

5.10.2 Signal pressure reading



To monitor the supply air and signal pressure, we recommend mounting pressure gauges (see accessories in Chapter 5.12).

Mounting the pressure gauges:

- ➔ See Chapter 5.2 and Chapter Fig. 5-7

5.10.3 Supply pressure

The required supply air pressure depends on the bench range and the actuator's direction of action (fail-safe action).

The bench range is written on the nameplate either as the bench range or signal pressure range depending on the actuator. The direction of action is marked FA or FE or by a symbol.

i Note

PLOW is indicated under Code 0 if the supply pressure is lower than the upper bench range value determined during plotting of the valve signature.

Actuator stem extends FA (AIR TO OPEN)

Fail-close (for globe and angle valves):

- ➔ Required supply pressure = Upper bench range value + 0.2 bar, at least 1.4 bar.

Actuator stem retracts FE (AIR TO CLOSE)

Fail-open (for globe and angle valves):

For tight-closing valves, the maximum signal pressure $p_{st_{max}}$ is roughly estimated as follows:

$$p_{st_{max}} = F + \frac{d^2 \cdot \pi \cdot \Delta p}{4 \cdot A} \text{ [bar]}$$

d = Seat diameter [cm]

Δp = Differential pressure across the valve [bar]

A = Actuator area [cm²]

F = Upper bench range value of the actuator [bar]

If there are no specifications, calculate as follows:

- ➔ Required supply pressure = Upper bench range value + 1 bar

5.10.4 Signal pressure (output)

The signal pressure at the output (38) of the positioner can be restricted to 1.4 bar, 2.4 bar or 3.7 bar in Code 16.

The limitation is not activated by default [7.0 bar].

5.11 Electrical connection

For electrical installation, observe the relevant electrotechnical regulations and the accident prevention regulations that apply in the country of use. In Germany, these are the VDE regulations and the accident prevention regulations of the employers' liability insurance.

⚠ WARNING

Incorrect electrical connection will render the explosion protection unsafe.

- *Adhere to the terminal assignment.*
- *Do not undo the enameled screws in or on the housing.*

⚠ WARNING

Intrinsic safety rendered ineffective in intrinsically safe devices.

- *Only connect intrinsically safe devices intended for use in intrinsically safe circuits to certified intrinsically safe input-connected units.*
- *Do not place intrinsically safe devices back into operation that were connected to intrinsically safe input-connected units without certification.*

- *Do not exceed the maximum permissible electric values specified in the EU type examination certificates when interconnecting intrinsically safe electrical equipment (U_i or U_0 , I_i or I_0 , P_i or P_0 , C_i or C_0 and L_i or L_0).*

The ambient temperature ranges of the tables in the EC type examination certificate apply for the assignment between the permissible ambient temperature, temperature class, maximum short-circuit currents and maximum power P_i and P_0 .

The following additionally applies: For positioners in type of protection Ex tb (Type 3730-65) and type of protection Ex nA (Type 3730-68), the cable glands and blanking plugs must be certified according to EN 60079-7 (Ex e).

Selecting cables and wires

- Observe **Clause 12 of EN 60079-14** for installation of the intrinsically safe circuits.

Clause 12.2.2.7 applies when running multi-core cables or wires with more than one intrinsically safe circuit.

The radial thickness of the insulation of a conductor for common insulating materials (e.g. polyethylene) must not be smaller than 0.2 mm. The diameter of an individual wire in a fine-stranded conductor must not be smaller than 0.1 mm. Protect the conductor ends against splicing, e.g. by using wire-end ferrules.

When two separate cables or wires are used for connection, an additional cable gland

can be installed. Seal cable entries left unused with plugs. Fit equipment used in ambient temperatures below $-20\text{ }^{\circ}\text{C}$ with metal cable entries

Equipment for use in zone 2/zone 22

In equipment operated according to type of protection Ex nA (non-sparking equipment) according to EN 60079-15, circuits may be connected, interrupted or switched while energized only during installation, maintenance or repair.

The special conditions of use mentioned in the statement of conformity must be observed for the rated values and the installation of the series-connected fuse for interconnection of Ex nA circuits.

For Ex nA equipment (non-sparking equipment), circuits may be connected, interrupted or switched while energized only during installation, maintenance or repair.

- Positioners with type of protection Ex nA or Ex tc can be used with a housing cover with or without window.
- The Type 3730-61, Type 3730-65 and Type 3730-68 Positioners are 100 % identical in design, except for the marking and the housing cover.
- For type of protection Ex nA, the VCC connection in the interface adapter must be connected in series with a fuse according to IEC 60127, 250 V F or T with a fuse rating of $I_N \leq 40\text{ mA}$.
- The signal current circuit must be connected in series with a fuse according to IEC 60127-2/VI, 250 V T with a fuse rating of $I_N \leq 63\text{ mA}$.

- The transmitter current circuit must be connected in series with a fuse according to IEC 60127-2/VI, 250 V T with a fuse rating of $I_N \leq 40\text{ mA}$.

The fuses must be installed outside the hazardous area.

Cable entry

Cable entry with M20x1.5 cable gland, 6 to 12 mm clamping range (see accessories in Table 5-4).

There is a second M20x1.5 threaded hole in the housing that can be used for additional connection, when required. The screw terminals are designed for wire cross-sections of 0.2 to 2.5 mm². Tighten the screws by 0.5 to 0.6 Nm.

The wires for the set point must be connected to the terminals 11 and 12 located in the housing.

Only use a **current source**.

$\geq 3.6\text{ mA}$: Microprocessor and display active

$< 3.7\text{ mA}$: LOW reading on display

$\leq 3.8\text{ mA}$: Emergency shutdown (version with shutdown at 3.8 mA)

$> 3.9\text{ mA}$: Supply to actuator possible (version with shutdown at 3.8 mA)

$\leq 4.4\text{ mA}$: Emergency shutdown (version with shutdown at 4.4 mA)

$> 4.6\text{ mA}$: Supply to actuator possible (version with shutdown at 4.4 mA)

$> 22\text{ mA}$: OVERLOAD reading on display

In general, it is not necessary to connect the positioner to a bonding conductor. However, if it is to be connected, it can be connected

Installation

either to the terminal for equipotential bonding inside or outside the device.

Depending on the version, the positioner is equipped with inductive limit switches and/or a solenoid valve.

The position transmitter is operated on a two-wire circuit. The usual supply voltage is 24 V DC. Taking the resistance of the supply leads into account, the voltage at the position transmitter terminals can be between 12 and 30 V DC.

Refer to Fig. 5-30 or to the label on the terminal block.

Connecting the electrical power

Before performing the pneumatic connection, make sure the following conditions are met:

- The positioner is properly mounted onto the control valve.
- The air supply is properly connected.

If this is the case:

- Connect the electrical power (mA signal) as shown in Fig. 5-30.

5.11.1 Switching amplifier according to EN 60947-5-6

For operation of the limit switches, switching amplifiers must be connected in the output circuit. To ensure the operating reliability of the positioner, the amplifiers must comply with the limit values of the output circuits conforming to EN 60947-5-6.

Observe the relevant regulations for installation in hazardous areas.

5.11.2 Establishing communication

Communication between computer and positioner using an FSK modem or handheld communicator (if necessary, using an isolation amplifier) is based on the HART® protocol.

Viator FSK modem

- | | | |
|----------|--------|---------------------|
| – RS-232 | Not ex | Order no. 8812-0130 |
| – PCMCIA | Not ex | Order no. 8812-0131 |
| – USB | Not ex | Order no. 8812-0132 |

If the load impedance of the controller or control station is too low, an isolation amplifier must be connected between controller and positioner (interfacing as for positioner connected in hazardous areas). See Fig. 5-31.

If the positioner is used in hazardous areas, an explosion-protected isolation amplifier must be used.

Using the HART® protocol, all connected control room and field units can be addressed individually using a point-to-point connection or the standard (multidrop) bus.

Point-to-point:

The bus address/polling address must always be set to zero (0).

Standard bus (multidrop):

In the standard bus (multidrop) mode, the positioner follows the analog current signal (reference variable) in the same way as for point-to-point communication. This operating mode is, for example suitable for split-range operation of positioners (series connection).

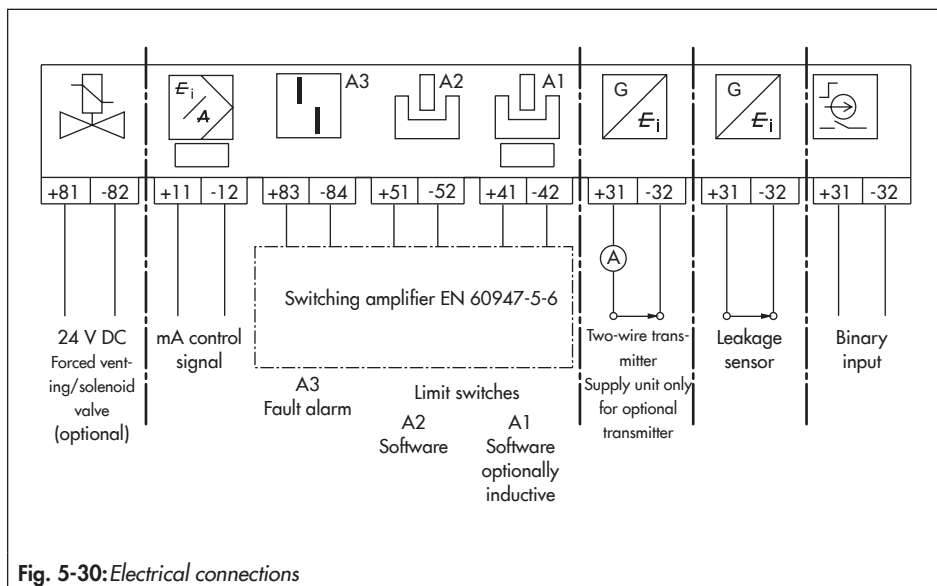

Fig. 5-30: Electrical connections

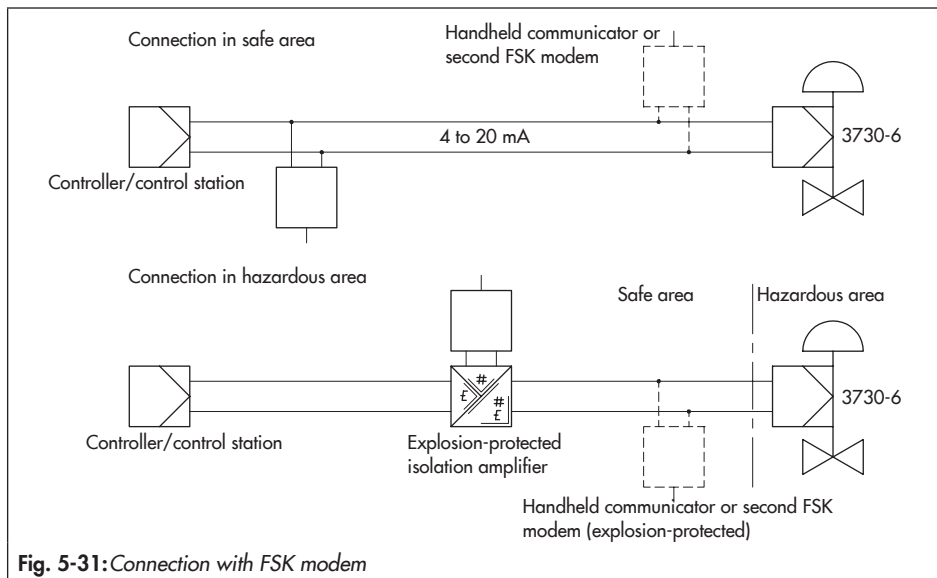

Fig. 5-31: Connection with FSK modem

Installation

The bus address/polling address has to be within a range of 1 to 15.

i Note

Communication errors may occur when the process controller/control station output is not HART®-compatible.

Alternatively, a $250\ \Omega$ resistor can be connected in series and a $22\ \mu\text{F}$ capacitor can be connected in parallel to the analog output. The load for the controller output will increase as a result.

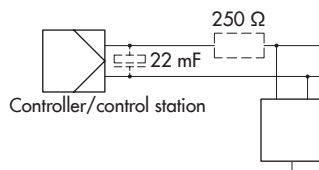

Fig. 5-32: Adapting the output signal

5.12 Mounting accessories

Table 5-4: General accessories

Designation		Order no.
Reversing amplifier for double-acting actuators		Type 3710
Cable gland M20x1.5	Black plastic (6 to 12 mm clamping range)	8808-1011
	Blue plastic (6 to 12 mm clamping range)	8808-1012
	Nickel-plated brass (6 to 12 mm clamping range)	1890-4875
	Nickel-plated brass (10 to 14 mm clamping range)	1922-8395
	Stainless steel 1.4305 (8 to 14.5 mm clamping range)	8808-0160
Adapter M20x1.5 to ½ NPT	Powder-coated aluminum	0310-2149
	Stainless steel	1400-7114

Designation		Order no.
Lever	S	0510-0522
	M	0510-0510
	L	0510-0511
	XL	0510-0512
	XXL	0510-0525
Retrofit kit for inductive limit switch 1 x SJ2-SN		1402-1770
Isolated USB interface adapter (SSP interface to USB port on a computer) including TROVIS-VIEW CD-ROM		1400-9740
Serial interface adapter (SAMSON SSP interface to RS-232 port on a computer)		1400-7700
TROVIS-VIEW 6661 (▶ www.samsongroup.com > SERVICE & SUPPORT > Downloads > TROVIS-VIEW)		

Table 5-5: Direct attachment to Type 3277-5 Actuator

Designation		Order no.	
Mounting parts	Standard version for actuators 120 cm ² or smaller	1400-7452	
	Version compatible with paint for actuators 120 cm ² or smaller	1402-0940	
Accessories for actuator	Old switchover plate for Type 3277-5xxxxxx. 00 Actuator (old)	1400-6819	
	New switchover plate for Type 3277-5xxxxxx. 01 Actuator (new) ¹⁾	1400-6822	
	New connecting plate for Type 3277-5xxxxxx. 01 Actuator (new) ¹⁾ , G ¼ and ½ NPT	1400-6823	
	Old connecting plate for Type 3277-5xxxxxx. 00 Actuator (old): G ¼	1400-6820	
	Old connecting plate for Type 3277-5xxxxxx. 00 Actuator (old): ½ NPT	1400-6821	
Accessories for positioner	Connecting plate (6)	G ¼	1400-7461
		¼ NPT	1400-7462
	Pressure gauge bracket (7)	G ¼	1400-7458
		¼ NPT	1400-7459
	Pressure gauge mounting kit (8) up to max. 6 bar (output/supply)	Stainless steel/brass	1402-0938
		Stainless steel/stainless steel	1402-0939
	Pressure gauge mounting kit (8) up to max. 6 bar (without inscription)	Stainless steel/brass	1402-1637
		Stainless steel/stainless steel	1402-1638

¹⁾ Only new switchover and connecting plates can be used with new actuators (Index 01). Old and new plates are not interchangeable.

Installation

Table 5-6: Direct attachment to Type 3277 Actuator

Mounting parts/accessories		Order no.
Standard version for actuators 175, 240, 350, 355, 700, 750 cm ²		1400-7453
Version compatible with paint for actuators 175, 240, 350, 355, 700, 750 cm ²		1402-0941
Connection block with seals and screw	G ¼	1400-8819
	¼ NPT	1402-0901
Pressure gauge mounting kit up to max. 6 bar (output/supply)	Stainless steel/brass	1402-0938
	Stainless steel/stainless steel	1402-0939
Piping with screw fittings ¹⁾		Order no.
Actuator (175 cm ²), steel	G ¼/G ¾	1402-0970
	¼ NPT/¾ NPT	1402-0976
Actuator (175 cm ²), stainless steel	G ¼/G ¾	1402-0971
	¼ NPT/¾ NPT	1402-0978
Actuator (240 cm ²), steel	G ¼/G ¾	1400-6444
	¼ NPT/¾ NPT	1402-0911
Actuator (240 cm ²), stainless steel	G ¼/G ¾	1400-6445
	¼ NPT/¾ NPT	1402-0912
Actuator (350 cm ²), steel	G ¼/G ¾	1400-6446
	¼ NPT/¾ NPT	1402-0913
Actuator (350 cm ²), stainless steel	G ¼/G ¾	1400-6447
	¼ NPT/¾ NPT	1402-0914
Actuator (355 cm ²), steel	G ¼/G ¾	1402-0972
	¼ NPT/¾ NPT	1402-0979
Actuator (355 cm ²), stainless steel	G ¼/G ¾	1402-0973
	¼ NPT/¾ NPT	1402-0980
Actuator (700 cm ²), steel	G ¼/G ¾	1400-6448
	¼ NPT/¾ NPT	1402-0915
Actuator (700 cm ²), stainless steel	G ¼/G ¾	1400-6449
	¼ NPT/¾ NPT	1402-0916
Actuator (750 cm ²), steel	G ¼/G ¾	1402-0974
	¼ NPT/¾ NPT	1402-0981
Actuator (750 cm ²), stainless steel	G ¼/G ¾	1402-0975
	¼ NPT/¾ NPT	1402-0982

¹⁾ For "actuator stem retracts" fail-safe action with air purging of the top diaphragm chamber

Table 5-7: Attachment to NAMUR rib or attachment to rod-type yokes ¹⁾ according to IEC 60534-6

Travel in mm	Lever	For actuator	Order no.
7.5	S	Type 3271-5 with 60/120 cm ² on Type 3510 Micro-flow Valve	1402-0478
5 to 50	M ²⁾	Actuators from other manufacturers and Type 3271 with 120 to 750 cm ² effective areas	1400-7454
14 to 100	L	Actuators from other manufacturers and Type 3271 with 1000 and 1400-60 cm ²	1400-7455
30 or 60	L	Type 3271, 1400-120 and 2800 cm ² versions with 30/60 mm travel ³⁾	1400-7466
		Mounting brackets for Emerson and Masoneilan linear actuators (in addition, a mounting kit according to IEC 60534-6 is required depending on the travel). See rows above.	1400-6771
		Valtek Type 25/50	1400-9554
40 to 200	XL	Actuators from other manufacturers and Type 3271 with 1400-120 and 2800 cm ² and with 120 mm travel	1400-7456
Accessories			Order no.
Connecting plate		G ¼	1400-7461
		¼ NPT	1400-7462
Pressure gauge bracket		G ¼	1400-7458
		¼ NPT	1400-7459
Pressure gauge mounting kit up to max. 6 bar (output/supply)		Stainless steel/brass	1402-0938
		Stainless steel/stainless steel	1402-0939

1) 20 to 35 mm rod diameter

2) M lever is mounted on basic device (included in the scope of delivery)

3) In conjunction with Type 3273 Side-mounted Handwheel with 120 mm rated travel, additionally one bracket (0300-1162) and two countersunk screws (8330-0919) are required.

Table 5-8: Attachment according to VDI/VDE 3847-1

Mounting parts	Order no.		
VDI/VDE 3847 interface adapter	1402-0257		
Connecting plate, including connection for air purging of actuator spring chamber	Aluminum	ISO 228/1-G ¼	1402-0268
		¼-18 NPT	1402-0269
	Stainless steel	ISO 228/1-G ¼	1402-0270
		¼-18 NPT	1402-0271
Mounting kit for attachment to SAMSON Type 3277 Actuator with 175 to 750 cm ²	1402-0868		
Mounting kit for attachment to SAMSON Type 3271 Actuator or third-party actuators	1402-0869		
Travel pick-off for valve travel up to 100 mm	1402-0177		
Travel pick-off for 100 to 200 mm valve travel (SAMSON Type 3271 Actuator only)	1402-0178		

Table 5-9: Attachment according to VDI/VDE 3847-2

Designation		Order no.
Mounting parts	Mounting block for PFEIFFER Type 31a (edition 2020+) Rotary Actuators with dummy plate for solenoid valve interface	1402-1645
	Blank plate for solenoid valve interface (sold individually)	1402-1290
	Adapter bracket for Type 3730 (VDI/VDE 3847)	1402-0257
	Adapter bracket for Type 3730 and Type 3710 (DAP/PST)	1402-1590
Accessories for actuator	Shaft adapter AA1	1402-1617
	Shaft adapter AA2	1402-1616
	Shaft adapter AA4	1402-1888

Table 5-10: Attachment to rotary actuators

Mounting parts/accessories		Order no.	
Attachment according to VDI/VDE 3845 (September 2010), actuator surface corresponds to fixing level 1			
	Size AA1 to AA4, version with CrNiMo steel bracket	1400-7448	
	Size AA1 to AA4, heavy-duty version	1400-9244	
	Size AA5, heavy-duty version (e.g. Air Torque 10 000)	1400-9542	
	Bracket surface corresponds to fixing level 2, heavy-duty version	1400-9526	
	Attachment for rotary actuators with max. 180° opening angle, fixing level 2	1400-8815 and 1400-9837	
Attachment to SAMSON Type 3278 with 160/320 cm ² , CrNiMo steel bracket		1400-7614	
Attachment to SAMSON Type 3278 with 160 cm ² and to VETEC Type S160, Type R and Type M, heavy-duty version		1400-9245	
Attachment to SAMSON Type 3278 with 320 cm ² and to VETEC Type S320, heavy-duty version		1400-5891 and 1400-9526	
Attachment to Camflex II		1400-9120	
Accessories	Connecting plate	G ¼	1400-7461
		¼ NPT	1400-7462
	Pressure gauge bracket	G ¼	1400-7458
		¼ NPT	1400-7459
	Pressure gauge mounting kit up to max. 6 bar (output/supply)	Stainless steel/brass	1402-0938
		Stainless steel/stainless steel	1402-0939

Table 5-11: Attachment of external position sensor

Mounting parts/accessories		Order no.
Template for mounting position sensor on older mounting parts		1060-0784
Direct attachment	Mounting parts for actuator with 120 cm ²	1400-7472
	Connecting plate (9, old) with $G \frac{1}{8}$	1400-6820
	Type 3277-5xxxxx.00 Actuator $\frac{1}{8}$ NPT	1400-6821
	Connecting plate (new) with Type 3277-5xxxxx.01 Actuator (new) ¹⁾	1400-6823
Mounting parts for actuators with 175, 240, 350, 355 and 750 cm ²		1400-7471
NAMUR attachment	Mounting parts for attachment to NAMUR rib using L or XL lever	1400-7468
Attachment to Type 3510 Micro-flow Valve	Mounting parts for Type 3271 Actuator with 60 cm ²	1400-7469
Attachment to rotary actuators	VDI/VDE 3845 (September 2010), see the 'Design and principle of operation' chapter for details.	
	Actuator surface corresponds to fixing level 1	
	Size AA1 to AA4 with follower clamp and coupling wheel, version with CrNiMo steel bracket	1400-7473
	Size AA1 to AA4, heavy-duty version	1400-9384
	Size AA5, heavy-duty version (e.g. Air Torque 10 000)	1400-9992
	Bracket surface corresponds to fixing level 2, heavy-duty version	1400-9974
	SAMSON Type 3278 with 160 cm ² and VETEC Type S160 and Type R, heavy-duty version	1400-9385
	SAMSON Type 3278 with 320 cm ² and VETEC Type S320, heavy-duty version	1400-5891 and 1400-9974
Accessories for positioner	Connecting plate (6) $G \frac{1}{4}$	1400-7461
	$\frac{1}{4}$ NPT	1400-7462
	Pressure gauge bracket (7) $G \frac{1}{4}$	1400-7458
	$\frac{1}{4}$ NPT	1400-7459
	Pressure gauge mounting kit up to max. 6 bar (output/supply) Stainless steel/brass	1402-0938
	Stainless steel/stainless steel	1402-0939
	Bracket to mount the positioner on a wall (Note: The other fastening parts are to be provided at the site of installation as wall foundations vary from site to site).	0309-0184

¹⁾ Only new connecting plates can be used with new actuators (Index 01). Old and new plates are not interchangeable.

6 Operation

⊗ Rotary pushbutton

The rotary pushbutton is located underneath the front protective cover. The positioner is operated on site using the rotary pushbutton:

Turn ⊗: Select codes and values

Press ⊗: confirm setting.

AIR TO OPEN/AIR TO CLOSE slide switch

- AIR TO OPEN applies to a valve opening as the signal pressure increases.
- AIR TO CLOSE applies to a valve closing as the signal pressure increases.

The signal pressure is the pneumatic pressure at the output of the positioner applied to the actuator.

Volume restriction Q

The volume restriction serves to adapt the air output capacity to the size of the actuator. Depending on the air passage at the actuator, two fixed settings are available.

- For actuators smaller than 240 cm² (Type 3271-5), select MIN SIDE.
- For actuators 240 cm² and larger, select MAX SIDE for a side connection.

Readings

Icons assigned to certain codes, parameters and functions are indicated on the display.

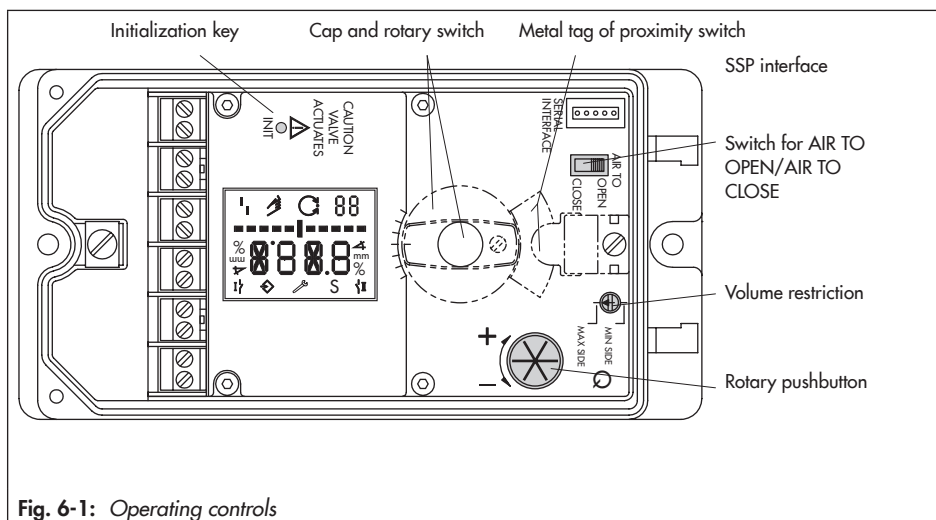







Fig. 6-1: Operating controls

Operation

Operating modes



-  (**manual mode**)
The positioner follows the manual set point (Code 1) instead of the mA signal.
 blinks: The positioner is not initialized. Operation only possible over manual set point (Code 1).
-  (**automatic mode**)
The positioner is in closed-loop operation and follows the mA signal.
- **S SAFE**
The positioner vents the output. The valve moves to the mechanical fail-safe position.

Bar graph

In manual  and automatic  modes, the bars indicate the set point deviation that depends on the sign (+/-) and the value. One bar element appears per 1 % set point deviation.

If the positioner has not been initialized, ( blinks on the display), the bar graph indicates the lever position in degrees in relation to the mid-axis. One bar element corresponds to approximately a 5° angle of rotation. The fifth bar element blinks (reading > 30°) if the permissible angle of rotation has been exceeded. Lever and pin position must be checked.

Status messages

-  Failure
-  Maintenance demanded/Maintenance required
-  blinks: Out of specification

These icons indicate that an error has occurred.

A classified status can be assigned to each error. Classifications include "No message", "Maintenance required", "Maintenance demanded" and "Failure" (► EB 8389-1 on EXPERTplus valve diagnostics).

⇒ Enable configuration

This indicates that the codes marked with an asterisk (*) in the code list are enabled for configuration (see the 'Start-up and configuration' chapter).

6.1 Serial interface

The positioner must be supplied with at least 3.8 mA.

The positioner can be connected directly to the computer over the local serial interface and the serial interface adapter. The operator software is TROVIS-VIEW (version 4) with installed device module 3730-6.

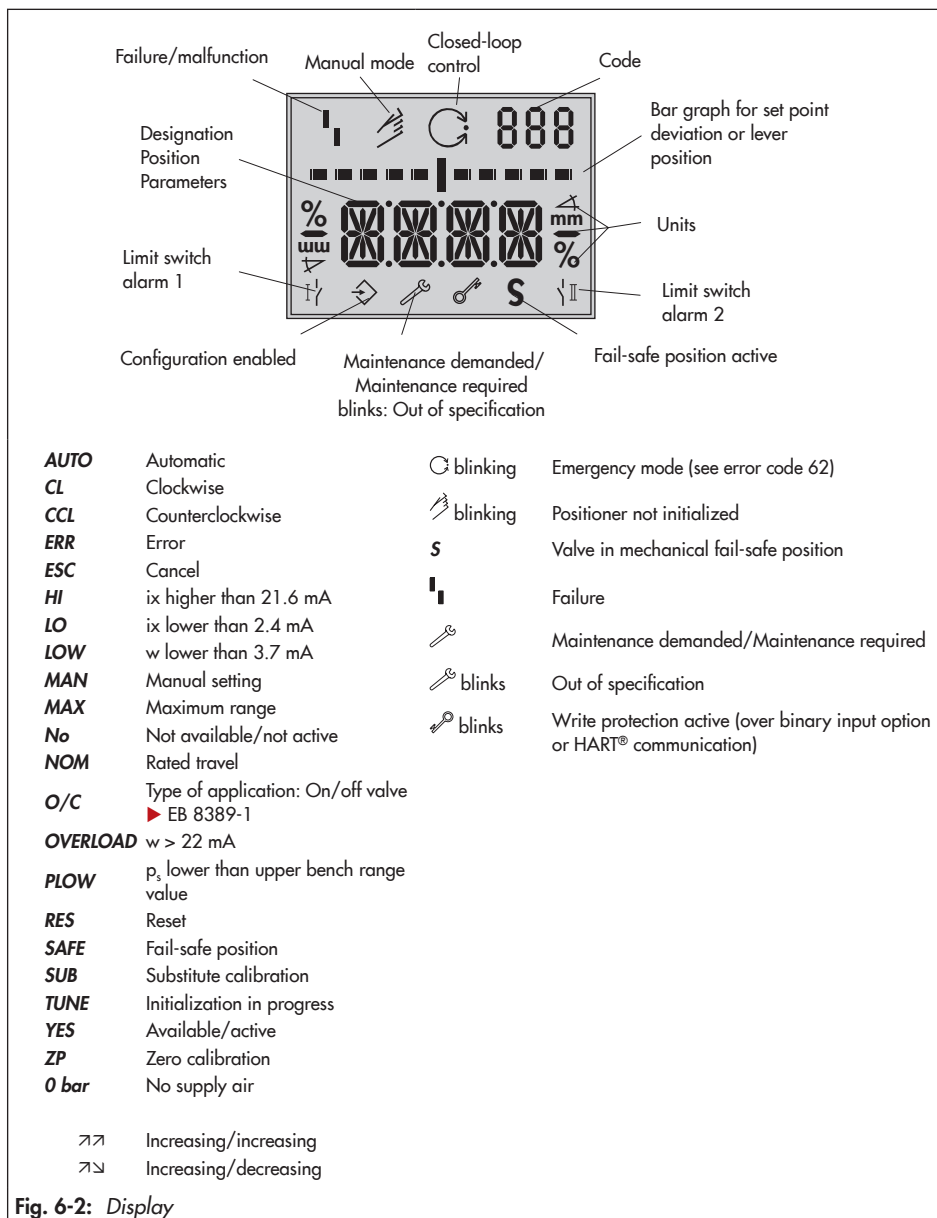

6.2 HART® communication

The positioner must be supplied with at least 3.6 mA. The FSK modem must be connected in parallel to the current loop.

A DTM file (Device Type Manager) conforming to the Specification 1.2 is available for communication. This allows the device, for example to be run with the PACTware user interface. All the positioner's parameters are accessible over the DTM and the user interface.

For start-up and settings, proceed as described in the 'Start-up and configuration' chapter. Refer to the code list in Appendix A for the parameters necessary for the user interface.

i Note

*If complex functions are started in the positioner, which require a long calculation time or lead to a large quantity of data being saved in the volatile memory of the positioner, the alert 'busy' is issued by the DTM file. This alert is **not an error message** and can be simply confirmed.*

Locking HART® communication

The write access for HART® communication can be disabled over Code 47. This function can only be enabled or disabled locally at the positioner.

Write access is enabled by default.

Locking on-site operation

The on-site operation including the INIT key can be locked over HART® communication. The word 'HART' then blinks on the display when Code 3 is selected. This locking function can only be disabled over HART® communication. On-site operation is enabled by default.

6.2.1 Dynamic HART® variables

The HART® specification defines four dynamic variables consisting of a value and an engineering unit. These variables can be assigned to device parameters as required. The universal HART® command 3 reads the dynamic variables out of the device. This allows manufacturer-specific parameters to also be transferred using a universal command.

In the Type 3730-6 Positioner, the dynamic variables can be assigned as listed in Table 6-1 in the Device settings folder (> Positioner > HART communication):

Table 6-1: *Dynamic HART® variables assignment*

Variable	Meaning	Unit
Set point	Set point	%
Direction of action set point	Direction of action set point	%
Set point after transit time specification	Set point after transit time specification	%
Valve position	Valve position	%
Set point deviation e	Set point deviation e	%
Absolute total valve travel	Absolute total valve travel	–
Binary input status	0 = Not active 1 = Active 255 = –/–	–
Internal solenoid valve/forced venting status	0 = De-energized 1 = Energized 2 = Not installed	–
Condensed state	0 = No message 1 = Maintenance required 2 = Maintenance demanded 3 = Failure 4 = Out of specification 7 = Function check	–
Temperature	Temperature	°C
Leakage sensor sound level	Leakage sensor sound level	dB
Ambient pressure	Ambient pressure	mbar
Signal pressure p _{out}	Signal pressure p _{out}	bar
Supply pressure	Supply pressure	bar
Flow rate	Flow rate	m ³ /h
Differential pressure	Differential pressure	bar
All active errors	0 = No errors 1 = Control loop 2 = Zero 4 = w too low 8 = PST/FST status 16 = On/off error activated 64 = Set point outside range 128 = Total valve travel exceeded 256 = Operating mode not AUTO	–

7 Start-up and configuration

The work described in this chapter is only to be performed by personnel appropriately qualified to carry out such tasks.

⚠ DANGER

Risk of fatal injury due to the ignition of an explosive atmosphere.

- Observe EN 60079-14 (VDE 0165, Part 1) for work on the positioner in potentially explosive atmospheres.
- Installation, operation or maintenance of the positioner must only be performed by personnel who has undergone special training or instructions or who is authorized to work on explosion-protected devices in hazardous areas.

⚠ WARNING

Crush hazard arising from moving parts on the valve.

- Do not touch any moving valve parts while the control valve is in operation.
- Before performing any mounting or installation work on the positioner, put the control valve out of operation by disconnecting and locking the supply air and control signal.
- Do not impede the movement of the actuator and plug stem by inserting objects into the yoke.

Before start-up, make sure the following conditions are met:

- The positioner is properly mounted according to the instructions.
- The pneumatic and electrical connections have been performed according to the instructions.

Reading after connecting the electrical power supply:



The wrench icon blinks on the display when the **positioner has not yet been initialized**. The reading indicates the lever position in degrees in relation to the mid-axis.

Code 0 is displayed when a **positioner has been initialized**. The positioner is in the last active operating mode.

The positioner performs a test in the start-up phase while following its automation task at the same time.

During the start-up phase, operation on site is unrestricted, yet write access is limited.

Sequence for start-up:

Action	Chapter
1. Determine the fail-safe position.	7.1
2. Adjust the volume restriction Q.	7.2
3. Limit the signal pressure.	7.3
4. Check the operating range of the positioner.	7.4
5. Initialize the positioner.	7.5
6. Configure the positioner by setting further parameters.	7.6
7. Positioners with inductive limit switches: Adjust the inductive limit switch.	7.7

7.1 Determining the fail-safe position

Define the fail-safe position of the valve (0 %) taking the valve type and the actuator's direction of action into account. Position the AIR TO OPEN/AIR TO CLOSE slide switch accordingly:

- **AIR TO OPEN** setting
Signal pressure opens the valve, e.g. for a fail-close valve
The AIR TO OPEN setting always applies to double-acting actuators.
- **AIR TO CLOSE** setting
Signal pressure closes the valve, e.g. for a fail-open valve

For checking purposes: after successfully completing initialization, the positioner display must read 0 % when the valve is closed and 100 % when the valve is open. If this is not the case, change the slide switch position and re-initialize the positioner.

i Note

The switch position is prompted prior to an initialization. After an initialization has been completed, changing the switch position does not have any effect on the operation of the positioner.

7.2 Adjusting the volume restriction Q

The volume restriction Q serves to adapt the air output capacity to the size of the actuator:

- **MAX BACK** setting for actuators with a **transit time <1 s**, e.g. linear actuators with an effective area smaller than 240 cm², require a restricted air flow rate.
- **MAX SIDE** setting for actuators with a **transit time ≥1 s** (the air flow rate does not need to be restricted.)

Intermediate settings are not permitted.

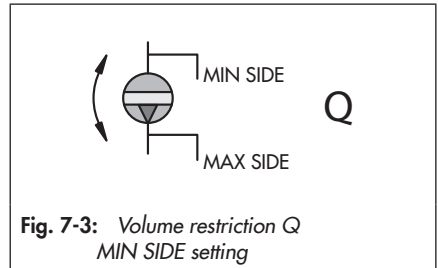

NOTICE

Malfunction due to changed start-up settings.

→ Initialize an initialized positioner again after the setting of the volume restriction has been changed.

7.3 Limiting the signal pressure





If the maximum actuator force may cause damage to the valve, the signal pressure must be limited.

→ Do not activate pressure limitation for double-acting actuators (AIR TO OPEN (AIO) fail-safe position). Default setting is 'No'.

Enable configuration at the positioner before limiting the signal pressure.

Enable configuration:

Configuration is locked again if no settings are entered within 120 s.



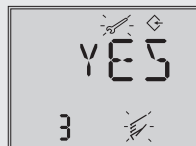

1. Turn  until Code 3 appears (reading: No).
2. Press , the code number 3 blinks.
3. Turn  until YES appears.
4. Press  to confirm (reading: .



Enable configuration
Default: No

Start-up and configuration

Limit the signal pressure:

1. Turn  until Code 16 appears.
2. Press , the code number 16 blinks.
3. Turn  until the required pressure limit (1.4/2.4/3.7 bar) appears.
4. Press  to confirm.







Pressure limit
Default: No

7.4 Checking the operating range of the positioner

To check the mechanical attachment and the proper functioning, the valve should be moved through the operating range of the positioner in the  manual mode with the manual set point.





Select manual mode :

1. Turn  until Code 0 appears.
2. Press , the code number 0 blinks.
3. Turn  until MAN appears.
4. Press . The positioner changes to the manual mode .



Operating mode
Default: MAN

Check the operating range:

1. Turn  until Code 1 appears.
2. Press , the code number 1 and  icon blink.
3. Turn  until the pressure in the positioner builds up and the control valve moves to its final positions so that the travel/angle can be checked.

The angle of rotation of the lever on the back of the positioner is indicated.

A horizontal lever (mid position) is equal to 0°.



Manual set point w
(current angle of rotation
is indicated)

To ensure the positioner is working properly, the outer bar elements must not blink while the valve is moving through the operating range.

Exit Code 1 by pressing the rotary pushbutton (⊗).

The permissible range has been exceeded when the displayed angle is more than 30° and the outer right or left bar element blinks. The positioner goes to the fail-safe position (SAFE). After canceling the fail-safe position (SAFE) (see the 'Operation' chapter) it is **absolutely essential** that you check the lever and pin position as described in the 'Installation' chapter.

⚠ WARNING

Risk of injury due to the actuator stem extending or retracting.

→ Before exchanging the lever or changing the pin position, disconnect the supply air and electrical auxiliary power.

7.5 Initializing the positioner

⚠ WARNING

Risk of injury by exposed moving parts on the positioner, actuator or valve.

→ Do not touch or block exposed moving parts.

ⓘ NOTICE

The process is disturbed by the movement of the actuator or valve.

→ Do not perform the initialization while the process is running. First isolate the plant by closing the shut-off valves.

→ Check the max. permissible signal pressure of the valve before starting initialization. During initialization, the positioner issues an output signal pressure up to the maximum supply pressure supplied. If necessary, limit the signal pressure by connecting an upstream pressure reducing valve.

i Note

Reset positioner to its default settings (see the 'Operation' chapter) before mounting it on a different actuator or changing its mounting position.

Start-up and configuration

During initialization the positioner adapts itself optimally to the friction conditions and the signal pressure required by the control valve. The type and extent of auto tuning depends on the initialization mode selected:

- **Maximum range (MAX)** (standard range)
Initialization mode for simple start-up of valves with two clearly defined mechanical end positions, e.g. three-way valves (see Chapter 7.5.1)
- **Nominal range (NOM)**
Initialization mode for all globe valves (see Chapter 7.5.2)
- **Manually selected OPEN position (MAN)**
Initialization mode for globe valves requiring OPEN position to be entered manually (see Chapter 7.5.3)
- **Manually selected end positions (MAN2)**
Initialization mode for globe valves with manual entry of both positions (see Chapter 7.5.4)
- **Substitute calibration (SUB)**
This mode allows a positioner to be replaced while the plant is running, with the least amount of disruption to the plant (see Chapter 7.5.5).

For normal operation, simply start initialization by pressing the INIT key after mounting the positioner on the valve and defining the fail-safe position and setting the volume restriction. The positioner only needs to work with its default settings. If necessary, perform a reset (see the 'Operation' chapter).

i Note

When the write protection  is activated, initialization cannot be started. An initialization procedure in progress can be canceled by pressing the rotary pushbutton. STOP is displayed for three seconds and the positioner changes to the fail-safe position (SAFE). Clear the fail-safe position again over Code 0 (see the 'Operation' chapter).

The time required for the initialization procedure depends on the actuator transit time, which means that initialization can take a few minutes.

After a successful initialization, the positioner runs in closed-loop operation indicated by the  closed-loop operation icon.

A malfunction leads to the process being canceled. The initialization error is displayed according to how it has been classified by the condensed state (see the 'Malfunction' chapter).



Alternating readings
Initialization in progress
Icon depending on initialization mode selected



Bar graph display indicating the progress of the initialization





Initialization successfully completed. Positioner in automatic mode ()

i Note

When Code 48 - h0 = YES, the diagnostics automatically start to plot the reference graphs required for the valve signature after initialization has been completed. This is indicated by TEST and D1 appearing on the display in alternating sequence.



An error during the plotting of the reference graphs is indicated on the display over Code 48 - h1 and Code 81. The reference graphs do not have any effect on closed-loop operation.

Fail-safe action AIR TO CLOSE

If the slide switch is set to AIR TO CLOSE, the positioner automatically switches to the direction of action increasing/decreasing ( ) after initialization has been completed. This results in the assignment (left) between set point and valve position.

The tight-closing function is activated.

Set Code 15 (set point cutoff increase) to 99 % **for three-way valves.**





Fail-safe position	Direction of action	Set point Valve	
		CLOSED at	OPEN at
Actuator stem extends (FA) AIR TO OPEN		0 %	100 %
Actuator stem retracts (FE) AIR TO CLOSE	 	100 %	0 %

7.5.1 MAX – Initialization based on maximum range

The positioner determines travel/angle of rotation of the closing member from the CLOSED position to the opposite travel stop and adopts this travel/angle of rotation as the operating range from 0 to 100 %.

Enable configuration:



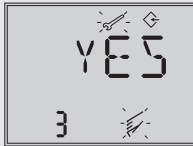

Configuration is locked again if no settings are entered within 120 s.

1. Turn  until Code 3 appears (reading: No).
2. Press , the code number 3 blinks.
3. Turn  until YES appears.
4. Press  to confirm (reading: ).



Enable configuration
Default: No



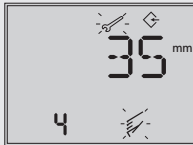

Enter the pin position:

1. Turn  until Code 4 appears.
2. Press , the code number 4 blinks.
3. Turn  to select pin position on lever (see relevant chapter on attachment).
4. Press  to confirm.



Pin position
Default: No

Select the initialization mode:

1. Turn  until Code 6 appears.
2. Press , the code number 6 blinks.
3. Turn  until MAX appears.
4. Press  to confirm the MAX initialization mode.



Default: MAX

Start initialization:

→ Press INIT key.

After initialization, the maximum travel/angle of rotation (Code 5) which was detected during initialization is indicated.

7.5.2 NOM – Initialization based on nominal range





The calibrated sensor allows the exact valve travel to be measured very accurately. During initialization, the positioner checks whether the control valve can move through the indicated nominal range (travel or angle) without collision. If this is the case, the indicated nominal range is adopted with the limits of travel/angle range start (Code 8) and travel/angle range end (Code 9) as the operating range.

i Note

The maximum possible travel must always be greater than the rated travel entered. If this is not the case, initialization is automatically canceled (error message Code 52) because the rated travel could not be achieved.

Enable configuration:





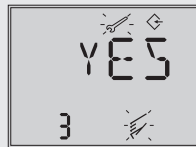



Configuration is locked again if no settings are entered within 120 s.

1. Turn  until Code 3 appears (reading: No).
2. Press , the code number 3 blinks.
3. Turn  until YES appears.
4. Press  to confirm (reading: ).



Enable configuration
Default: No

Enter the pin position and nominal range:

1. Turn  until Code 4 appears.
2. Press , the code number 4 blinks.
3. Turn  to select pin position on lever (see relevant chapter on attachment).
4. Press  to confirm.
5. Turn  until Code 5 appears.
6. Press , the code number 5 blinks.
7. Turn  and set rated travel of the valve.
8. Press  to confirm.





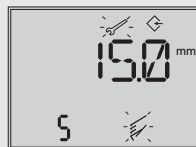

Pin position
Default: No



Nominal range
(locked when Code 4 = No)

Start-up and configuration

Select the initialization mode:

1. Turn  until Code 6 appears.
2. Press , the code number 6 blinks.
3. Turn  until *NOM* appears.
4. Press  to confirm the *NOM* initialization mode.



Init mode
Default: MAX

Start initialization:





- Press INIT key.
- After the initialization has been successfully completed:
Check the direction of action (Code 7) and, if necessary, change it.

7.5.3 MAN – Initialization based on a manually selected OPEN position

Before starting initialization, move the control valve manually to the OPEN position. The positioner calculates the differential travel/angle from the OPEN and CLOSED positions and adopts it as the operating range with limits of lower travel/angle range value (Code 8) and upper travel/angle range value (Code 9).

Enable configuration:



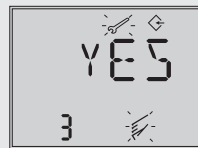

Configuration is locked again if no settings are entered within 120 s.

1. Turn  until Code 3 appears (reading: No).
2. Press , the code number 3 blinks.
3. Turn  until *YES* appears.
4. Press  to confirm (reading: ).



Enable configuration
Default: No



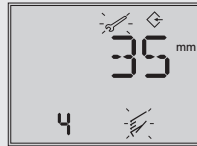

Enter the pin position:

1. Turn  until Code 4 appears.
2. Press , the code number 4 blinks.
3. Turn  to select pin position on lever (see relevant chapter on attachment).
4. Press  to confirm.



Pin position
Default: No









Select the initialization mode:

1. Turn  until Code 6 appears.
2. Press , the code number 6 blinks.
3. Turn  until MAN appears.
4. Press  to confirm the MAN initialization mode.



Init mode
Default: MAX

Enter OPEN position:

1. Turn  until Code 0 appears.
2. Press , the code number 0 blinks.
3. Turn  until MAN appears.
4. Press  to confirm.
5. Turn  until Code 1 appears.
6. Press , the code number 1 blinks.
7. Turn  clockwise in small steps until the required valve position is reached. The valve must be moved with a monotonically increasing signal pressure.
8. Press  to confirm the OPEN position.



Manual set point
(current angle of rotation is indicated)

Start initialization:

- Press INIT key.

7.5.4 MAN2 – Initialization based on manually selected end positions





Before starting initialization, move the control valve manually to the end positions. The positioner calculates the travel/angle difference from the positions that the valve moved to and adopts it as the operating range with limits of lower travel/angle range value (Code 8) and upper travel/angle range value (Code 9).

i Note

This initialization mode can only be started when the valve position differs in the end positions and the positioner has not yet been initialized.

Enable configuration:



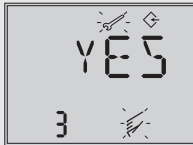

Configuration is locked again if no settings are entered within 120 s.

1. Turn  until Code 3 appears (reading: No).
2. Press , the code number 3 blinks.
3. Turn  until YES appears.
4. Press  to confirm (reading: ).



Enable configuration
Default: No

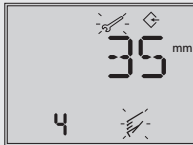

Enter the pin position:

1. Turn  until Code 4 appears.
2. Press , the code number 4 blinks.
3. Turn  to select pin position on lever (see relevant chapter on attachment).
4. Press  to confirm.





Pin position
Default: No

Select the initialization mode and enter end positions:

1. Turn  until Code 6 appears.
2. Press , the code number 6 blinks.
3. Turn  until MAN appears.



Init mode
Default: MAX

4. Press  to confirm the MAN2 as the initialization mode. POS1 and the current angle of the lever are indicated on the display in alternating sequence.
5. Turn  clockwise in small steps until the required valve position is reached. The valve must be moved with a monotonically increasing signal pressure.





POS1 (end position 1)



POS2 (end position 2)

Press  to confirm the valve position (reading: *WAIT*). The valve position is adopted after the pressure settles. POS2 and the current angle position of the lever are indicated on the display in alternating sequence.

Turn  until the valve reaches its OPEN position.

Press  to confirm the valve position (reading: *WAIT*). Initialization can be started as soon as MAN2 is indicated again on the display.

Start initialization:

→ Press INIT key.

After initialization, the tight-closing function (Code 14) is deactivated.

7.5.5 SUB – Substitute calibration

A complete initialization procedure takes several minutes and requires the valve to move through its entire travel range several times. In the SUB initialization mode, the control parameters are estimated and not determined by an initialization procedure. As a result, a high level of accuracy cannot be expected. A different initialization mode should be selected if the plant allows it.

The substitute calibration is used to replace a positioner while the process is running. For this purpose, the control valve is usually fixed mechanically in a certain position or pneumatically

Start-up and configuration





by means of a pressure signal which is routed to the actuator externally. The blocking position ensures that the plant continues to operate with this valve position.

The blocking position can also be the fail-safe position when this condition is beneficial for the temporary phase.

→ Perform a reset before re-initializing the positioner if the substitute positioner has already been initialized (see the 'Operation' chapter).

Enable configuration:





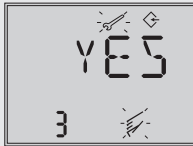



Configuration is locked again if no settings are entered within 120 s.

1. Turn  until Code 3 appears (reading: No).
2. Press , the code number 3 blinks.
3. Turn  until YES appears.
4. Press  to confirm (reading: ).



Enable configuration
Default: No

Enter the pin position and nominal range:

1. Turn  until Code 4 appears.
2. Press , the code number 4 blinks.
3. Turn  to select pin position on lever (see relevant chapter on attachment).
4. Press  to confirm.
5. Turn  until Code 5 appears.
6. Press , the code number 5 blinks.
7. Turn  and set rated travel of the valve.
8. Press  to confirm.

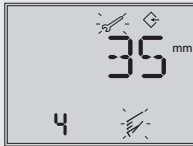



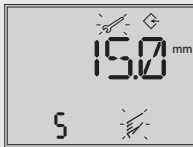

Pin position
Default: No



Nominal range
(locked when Code 4 =
No)





Select the initialization mode:

1. Turn  until Code 6 appears.
2. Press , the code number 6 blinks.
3. Turn  until *SUB* appears.
4. Press  to confirm the SUB initialization mode.



Init mode
Default: MAX



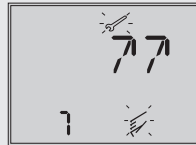

Enter the direction of action:

1. Turn  until Code 7 appears.
2. Press , the code number 7 blinks.
3. Turn  to select the direction of action (\rightarrow / \leftarrow).
4. Press  to confirm.



Direction of action
Default: \rightarrow

Deactivate travel limit:

1. Turn  until Code 11 appears.
2. Press , the code number 11 blinks.
3. Turn  until *No* appears.
4. Press  to deactivate the travel limit function.







Travel limitation
Default: No

Change pressure limit and control parameters:

 Note

Do not change the pressure limit (Code 16). Only change the control parameters K_p (Code 17) and T_V (Code 18) if the settings of the replaced positioner are known.

Start-up and configuration

1. Turn  until the required Code 16/17/18 appears.
2. Press , the code number 16/17/18 blinks.
3. Turn  to set the control parameter selected.
4. Press  to confirm.



Pressure limit
Default: No

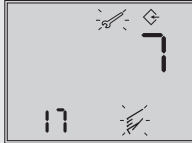







K_p level
Default: 7



T_v level
Default: 2

Enter closing direction and blocking position:

1. Turn  until Code 34 appears.
2. Press , the code number 34 blinks.
3. Turn  and set the closing direction (CCL = counterclockwise/CL = clockwise).
4. Press , to confirm.
5. Turn  until Code 35 appears.
6. Press , the code number 35 blinks.
7. Turn  to set the blocking position, e.g. 5 mm (read off at travel indicator scale of the blocked valve or measure with a ruler).
8. Set switch for fail-safe position AIR TO OPEN or AIR TO CLOSE according to Chapter 7.1.
9. Adjust volume restriction as described in Chapter 7.2.



Closing direction (direction of rotation causing the valve to move to the CLOSED position (view onto positioner display); standard CCL

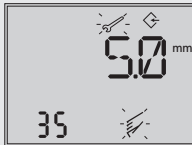

Blocking position
Default: 0

Start initialization:

- Press INIT key.
The operating mode is changed to automatic mode .

Since initialization has not been completed, the error code 76 (no emergency mode) and possibly also error code 57 (control loop) may appear on the display. These alarms do not influence the positioner's readiness for operation.

- If the positioner shows a tendency to oscillate in automatic mode, the parameters K_p and T_V must be slightly corrected. Proceed as follows:
 - Set T_V (Code 18) to 4.
 - If the positioner still oscillates, the gain K_p (Code 17) must be decreased until the positioner shows a stable behavior.

Zero point calibration





- Finally, if process operations allow it, the zero point must be calibrated according to the 'Operation' chapter.

7.5.6 Tuning the KP input filter

Changing the KP level (Code 17) affects the set point deviation. This effect can be compensated for by tuning the input filter without having to re-initialize the positioner.

Enable configuration:

Configuration is locked again if no settings are entered within 120 s.

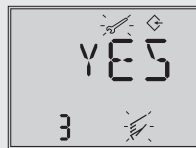

1. Turn  until Code 3 appears (reading: No).
2. Press , the code number 3 blinks.
3. Turn  until YES appears.
4. Press  to confirm (reading: .



Enable configuration
Default: No

Start-up and configuration

Tune the input filter:

1. Turn  until Code 6 appears.
 2. Press , the code number 6 blinks.
 3. Turn  until *KP* appears.
- Press INIT key.
During the tuning, the valve moves through its whole range and the input filter is recalibrated.



Tuning the input filter
Default: MAX

7.6 Setting other parameters



All codes and their meaning and default settings are listed in the code list in Appendix A. Codes which are marked with an asterisk must be enabled with Code 3 before the associated parameters can be configured as described below.

Turn  until Code 3 appears (reading: *No*).

Press , the code number 3 blinks.

Change the setting in Code 3.

Turn  until *YES* appears.

Press , reading: .

Configuration is enabled.

You can now configure codes one after the other:

Turn  to select the required code.

Press , to activate the selected code. The code number starts to blink.

Turn  to select the setting.

Press , to confirm the selected setting.

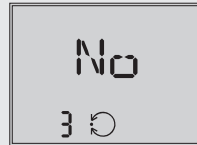

Code 3
Configuration not enabled

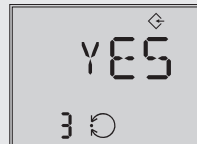

Configuration enabled

If no settings are entered within 120 seconds, the enabled configuration function becomes invalid and the display returns to Code 0.

Cancel the setting:

To cancel a value before it is confirmed (by pressing ) proceed as follows:

Turn  until ESC appears.

Press  to confirm.

The entered value is not adopted.



Canceling the reading

7.7 Adjusting inductive limit switch

The positioner version with an inductive limit switch has an adjustable tag (1) mounted on the axis of rotation, which operates the proximity switch (3).

For operation of the inductive limit switch, the corresponding switching amplifier (see the 'Installation' chapter) must be connected to the output circuit.

When the tag (1) is located in the inductive field of the contact, the switch assumes a high resistance. When it moves outside the field, the switch assumes a low resistance.

Normally, the limit switch is adjusted in such a way that it will provide a signal in both end positions of the valve. The contact, however, can also be adjusted to indicate intermediate valve positions.

The required switching function, i.e. whether the output relay is to be picked up or released when the tag enters the field, must be selected at the switching amplifier, if required.

i Note

The inductive limit switch replaces the software limit switch A1 with terminal assignment +41/-42.

Each switching position can optionally be set to indicate when the tag has entered the field or when it has left the field.

The second software limit switch remains effective, the function of the software limit switch A1 is disabled.

Software adaptation

- Code 38 (inductive alarm is set to YES).
- The inductive limit switch is connected to the terminals +41/-42 (see the 'Installation' chapter).
- The device is set up accordingly in the delivered state.

Start-up and configuration

Adjust the switching point

i Note

During adjustment or testing, the switching point must always be approached from mid-position (50 %).

To guarantee the switching under all ambient conditions, adjust the switching point approx. 5 % before the mechanical stop (OPEN – CLOSED).

For CLOSED position:

1. Initialize the positioner.
2. Move the valve to 5 % in the MAN mode (see display).
3. Adjust the tag at the yellow adjustment screw (2) until the tag enters or leaves the field and the switching amplifier responds.
You can measure the switching voltage as an indicator.

Contact function:

- Tag leaving the field > contact is closed.
- Tag entering the field > contact is opened.

For OPEN position:

1. Initialize the positioner.
2. Move the valve to 95 % in the MAN mode (see display).
3. Adjust the tag (1) at the yellow adjustment screw (2) until the tag enters or leaves the field of the proximity switch (3).
You can measure the switching voltage as an indicator.

Contact function:

- Tag leaving the field > contact is closed.
- Tag entering the field > contact is opened.

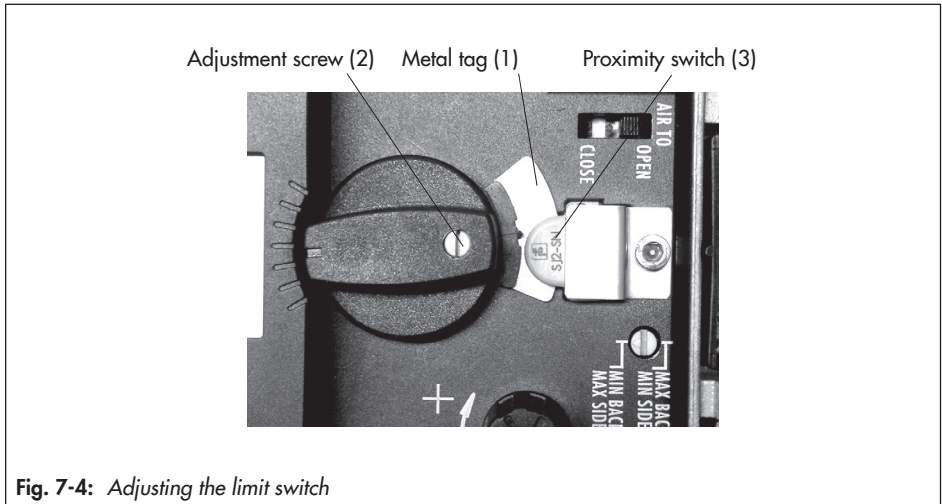

Fig. 7-4: *Adjusting the limit switch*

8 Operation

The work described in this chapter is only to be performed by personnel appropriately qualified to carry out such tasks.

⚠ DANGER

Risk of fatal injury due to the ignition of an explosive atmosphere.

- Installation, operation or maintenance of the positioner must only be performed by personnel who has undergone special training or instructions or who is authorized to work on explosion-protected devices in hazardous areas.





⚠ WARNING

Crush hazard arising from moving parts on the valve.

- Do not touch any moving valve parts while the control valve is in operation.
- Before performing any mounting or installation work on the positioner, put the control valve out of operation by disconnecting and locking the supply air and control signal.
- Do not impede the movement of the actuator and plug stem by inserting objects into the yoke.

8.1 Adapting the display direction

The display contents can be turned by 180° to adapt the display reading to the actuator's mounting situation. If the displayed data appear upside down, proceed as follows:

1. Turn  until Code 2 appears.
2. Press , the code number 2 blinks.
3. Turn  and select the desired reading direction.
4. Press  to confirm.

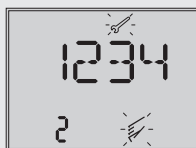

Reading direction for right attachment of pneumatic connections



Reading direction for left attachment of pneumatic connections

8.2 Changing the operating modes

8.2.1 Closed-loop operation (automatic mode)





After initialization has been completed successfully, the positioner is in  automatic mode (AUTO).



Automatic mode

8.2.2 Manual mode

Switching to  manual mode (MAN):

1. Turn  until Code 0 appears.
2. Press , reading: *AUTO*, the code number 0 blinks.
3. Turn  until *MAN* appears.
4. Press . The positioner changes to the manual mode (.

The manual mode starts using the last set point used in automatic mode, ensuring a bumpless changeover. The current position is displayed in %.





Automatic mode



Manual mode



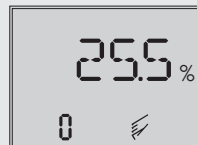

Adjusting the manual set point:

1. Turn  until Code 1 appears.
2. Press , the code number 1 blinks.
3. Turn  until sufficient pressure has been built up in the positioner and the control valve moves to the required position.







The positioner automatically returns to Code 0 if no settings are made within 120 seconds, but remains in the manual mode.

Switch to automatic mode

1. Turn  until Code 0 appears.
2. Press , the code number 0 blinks.
3. Turn  until *AUTO* appears.
4. Press . The positioner switches to automatic mode.

8.2.3 Fail-safe position (SAFE)





If you want to move the valve to the fail-safe position determined during start-up (see the 'Start-up and configuration' chapter), proceed as follows:

1. Turn  until Code 0 appears.
2. Press , reading: current operating mode (AUTO or MAN), the code number 0 blinks.
3. Turn  until *SAFE* appears.
4. Press , reading: *S*



The valve moves to the fail-safe position.
If the positioner has been initialized, the current valve position in % is indicated on the display.

Exiting the fail-safe position:

1. Turn  until Code 0 appears.
2. Press , the code number 0 blinks.
3. Turn  and select the required operating mode (AUTO or MAN).
4. Press  to confirm.
5. The positioner switches to the operating mode selected.

8.3 Performing zero calibration

In case of inconsistencies in the closed position of the valve, e.g. with soft-seated plugs, it might be necessary to recalibrate zero.

⚠ WARNING

Risk of injury due to the actuator stem extending or retracting.

→ Do not touch or block the actuator stem.

ⓘ NOTICE

The process is disturbed by the movement of the actuator stem.





→ Do not perform zero calibration while the process is running. First isolate the plant by closing the shut-off valves.

The positioner must be connected to the supply air to perform the zero calibration.

A zero calibration is not possible if there is zero point shift of more than 5 %. In this case, Code 54 is activated. The positioner must be re-initialized.

Enable configuration:

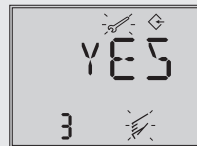

Configuration is locked again if no settings are entered within 120 s.

1. Turn  until Code 3 appears (reading: No).
2. Press , the code number 3 blinks.
3. Turn  until YES appears.
4. Press  to confirm (reading: ).



Enable configuration
Default: No

Perform zero calibration:

1. Turn  until Code 6 appears.
 2. Press , the code number 6 blinks.
 3. Turn  until ZP appears.
- Press INIT key.
Zero calibration starts. The positioner moves the valve to the CLOSED position and recalibrates the internal electrical zero point.

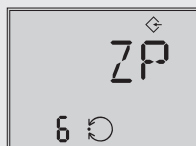

Init mode
Default: MAX

8.4 Resetting the positioner

A reset allows the positioner to be reset to the default settings. To reset the positioner, the options DIAG, STD and DS are available in Code 36. Table 8-2 lists the reset functions.





i Note

Code 36 – DS is usually selected when the valve is mounted in another position or when the positioner is to be mounted to another valve.

Performing a reset does not necessarily mean the positioner must be re-initialized.

Enable configuration:

Configuration is locked again if no settings are entered within 120 s.



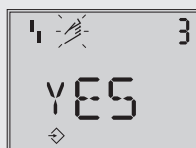

1. Turn  until Code 3 appears (reading: No).
2. Press , the code number 3 blinks.
3. Turn  until YES appears.
4. Press  to confirm (reading: .



Enable configuration
Default: No

Operation

Reset start-up parameters:

1. Turn  until Code 36 appears (reading: ●●-●●-).
 2. Press , the code number 36 blinks.
 3. Turn  until *DIAG/STD/DS* appears.
 4. Press  to confirm.
- The parameters are reset depending on the setting made (see Table 8-2).

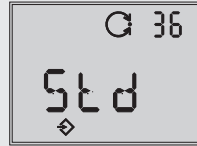

Reset
Default: No



Table 8-2: Reset functions

		Reset Code 36		
		DIAG	STD	DS
Initialization		No	YES	YES
Fail-safe action				
Air supply failure		No	No	YES
Power supply failure of positioner		No	No	YES
Power supply failure of external solenoid valve		No	No	YES
Emergency mode		No	No	No
Operating hours counter		No	No	No
Device in operation		No	YES	YES
Device switched on since initialization		No	YES	YES
Device in operation since initialization		No	YES	YES
Logging		No	YES	YES
Code	Parameters			
2	Reading direction	No	YES	YES
4	Pin position	No	YES	YES
5	Nominal range	No	YES	YES
6	Initialization mode	No	YES	YES
7	Direction of action	No	YES	YES
8	Lower travel/angle range value	No	YES	YES
9	Upper travel/angle range value	No	YES	YES

		Reset Code 36		
		DIAG	STD	DS
10	Lower travel/angle range value	No	YES	YES
11	Upper travel/angle range value	No	YES	YES
12	Set point, lower range value	No	YES	YES
13	Set point, upper range value	No	YES	YES
14	CLOSED end position	No	YES	YES
15	OPEN end position	No	YES	YES
16	Pressure limit	No	YES	YES
17	Proportional-action coefficient Kp level	No	No	No
18	Derivative-action time Tv level	No	No	No
19	Tolerance band	No	YES	YES
20	Valve characteristic selection	No	YES	YES
21	Enter transit time OPEN	No	YES	YES
22	Enter transit time CLOSED	No	YES	YES
24	Total valve travel limit	No	YES	YES
25	Alarm mode	No	YES	YES
26	Limit A1	No	YES	YES
27	Limit A2	No	YES	YES
32	Error message in case of condensed state 'Function check'	No	YES	YES
33	Error message in case of 'Maintenance required' and 'Out of specification' condensed states	No	YES	YES
38	Inductive limit switch	No	No	No
46	Bus address	No	No	YES
48 - 49 -	Diagnostics (▶ EB 8389-1)			

9 Malfunction

Malfunctions are indicated on the display by error codes. Appendix A lists possible error messages and recommended action.

The error codes appear on the display corresponding to their status classification set over the condensed state (Maintenance required/Maintenance demanded: , Out of specification:  blinking, Failure: ). If 'No message' is assigned to the error code as the status classification, the error is not included in the condensed state.

A status classification is assigned to every error code in the default setting. The assignment of the status classification can be changed in TROVIS-VIEW and over the parameters of the DD. Refer to the operating instructions for the valve diagnostics

► EB 8389-1 on EXPERTplus valve diagnostics for more details.

To provide a better overview, the classified messages are summarized in a condensed state for the positioner according to the NAMUR Recommendation NE 107. The status messages are divided into the following categories:

– Failure

The positioner cannot perform its control task due to a malfunction in the positioner itself or in one of its peripherals or the positioner has not yet been successfully initialized.

– Maintenance required

The positioner still performs its control task (with restrictions). A maintenance demand or above average wear has

been determined. The wear tolerance will soon be exhausted or is reducing at a faster rate than expected. Maintenance is necessary in the medium term.

– Maintenance demanded



The positioner still performs its control task (with restrictions). A maintenance demand or above average wear has been determined. The wear tolerance will soon be exhausted or is reducing at a faster rate than expected. Maintenance is necessary in the short term.

– Out of specification

The positioner is running outside the specified operating conditions.

If an event is classified as “No message”, this event does not have any affect on the condensed state.

Table 9-1: Condensed state reading

Condensed state	Positioner display
Failure	
Function check	Text e.g. <i>TUNE</i> or <i>TEST</i>
Maintenance required/ maintenance demanded	
Out of specification	 blinking

The message with the highest priority determines the condensed state in the positioner.

9.1 Troubleshooting

⚠ DANGER

Risk of fatal injury due to the ignition of an explosive atmosphere.

→ Installation, operation or maintenance of the positioner must only be performed by personnel who has undergone special training or instructions or who is authorized to work on explosion-protected devices in hazardous areas.

⚠ WARNING

Crush hazard arising from moving parts on the valve.

- Do not touch any moving valve parts while the control valve is in operation.
- Before performing any mounting or installation work on the positioner, put the control valve out of operation by disconnecting and locking the supply air and control signal.
- Do not impede the movement of the actuator and plug stem by inserting objects into the yoke.

Table 9-1 lists general errors.

If the positioner detects an error, the possible source of error is displayed in Code 49 onwards. In this case, *ERR* is displayed.

Example:

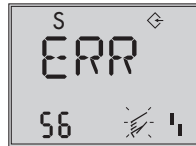

Example:
Error caused by pin position

→ Refer to the code list (Appendix A) for possible causes and the recommended action.

Fault alarm output

'Failure' as the condensed state causes the optional fault alarm output to be switched.

- The 'Function check' condensed state can also activate the fault alarm output (Code 32).
- The 'Maintenance required/Maintenance demanded' condensed state and 'Out of specification' can also activate the fault alarm output (Code 33).

Confirming error messages

1. Turn **⊗** until Code 3 appears (reading: No).
 2. Press **⊗**, the code number 3 blinks.
 3. Turn **⊗** until YES appears.
 4. Press **⊗** to confirm (reading: **⇒**).
1. Turn **⊗** until the the error code that you want appears.
 2. Press **⊗** to confirm the error message.

i Note

Contact SAMSON's After-sales Service for malfunctions that cannot be remedied as described in Table 9-2 and the code list in Appendix A.

Table 9-2: Further troubleshooting

Description of fault	Measures
No reading on the display	<ul style="list-style-type: none"> → Check electrical connection and electrical power. → Check the ambient temperature (the display's operating range is from -30 to $+65$ °C).
Actuator moves too slowly	<ul style="list-style-type: none"> → Check the supply pressure. → Deactivate software restriction. → Check the cross-section of the piping and screw fittings. → Check the configuration of the mounting parts.
Actuator moves in the wrong direction.	<ul style="list-style-type: none"> → Check the characteristic setting. → Check the piping. → Check the configuration of the mounting parts.
Air leaks from the positioner.	<ul style="list-style-type: none"> → Check attachment. → Check the seals in the connecting plate.

9.2 Emergency action

Fail-safe action is triggered by the i/p converter or solenoid valve and upon supply air failure. The positioner fully discharges its pneumatic output to the atmosphere, causing the pneumatic actuator to be vented. As a result, the valve moves to the fail-safe position. The fail-safe position depends on how the springs are arranged in the pneumatic actuator (air-to-close or air-to-open).

When the supply air fails, the optional solenoid valve or forced venting is triggered and after reaching the shutdown signal, all positioner functions, except open/closed loop control, remain active (including diagnostics as well as position and status feedback).



Tip

Emergency action in the event of valve or actuator failure is described in the associated valve and actuator documentation.

→ Plant operators are responsible for emergency action to be taken in the plant.

10 Servicing

The work described in this chapter is only to be performed by personnel appropriately qualified to carry out such tasks.

⚠ DANGER

Risk of fatal injury due to the ignition of an explosive atmosphere.

- Installation, operation or maintenance of the positioner must only be performed by personnel who has undergone special training or instructions or who is authorized to work on explosion-protected devices in hazardous areas.

⚠ WARNING

Crush hazard arising from actuator and plug stem moving.

- Do not touch any moving valve parts while the control valve is in operation.
- Before performing any mounting or installation work on the positioner, put the control valve out of operation by disconnecting and locking the supply air and control signal.
- Do not impede the movement of the actuator and plug stem by inserting objects into the yoke.

⚠ WARNING

Intrinsic safety rendered ineffective in intrinsically safe devices.

- Only connect intrinsically safe devices intended for use in intrinsically safe circuits

to certified intrinsically safe input-connected units.

- Do not place intrinsically safe devices back into operation that were connected to intrinsically safe input-connected units without certification.
- Do not exceed the maximum permissible electric values specified in the EU type examination certificates when interconnecting intrinsically safe electrical equipment (U_i or U_o , I_i or I_o , P_i or P_o , C_i or C_o and L_i or L_o).

The positioner was checked by SAMSON before it left the factory.

- The product warranty becomes void if service or repair work not described in these instructions is performed without prior agreement by SAMSON's After-sales Service.
- Only use original spare parts by SAMSON, which comply with the original specifications.

The positioner does not require any maintenance.

10.1 Cleaning the cover window

Occasionally, the window in the cover may need to be cleaned.

! NOTICE

Incorrect cleaning will damage the window. The window is made of Makrolon® (new design) and will be damaged when cleaned with abrasive cleaning agents or agents containing solvents.

- Do not rub the window dry.
- Do not use any cleaning agents containing chlorine or alcohol or abrasive cleaning agents.
- Use a non-abrasive, soft cloth for cleaning.

10.2 Cleaning the filters

There are filters with a 100 µm mesh size in the pneumatic connections for supply and output which can be removed and cleaned, if required.

10.3 Maintenance of the supply air pressure reducing stations

The maintenance instructions of any upstream supply air pressure reducing stations must be observed.

10.4 Firmware updates

Firmware updates on positioners currently in operation can be performed as described below. Only individuals with a written approval may perform updates. Approved individuals are named by SAMSON's Quality Management and assigned a test mark.

Laptops and computers connected to the power supply must only be interconnected with intrinsically safe equipment if the SAMSON isolated USB interface adapter (order no. 1400-9740) is connected in-between for software programming or test routines.

Updates outside the hazardous area:

- Remove the positioner and perform the update outside the hazardous area.



Updates on site:

- Updates on site are only permitted after the plant operator presented a signed hot work permit.
- After updating has been completed, add the current firmware to the nameplate (e.g. using a label).
- The individual approved by SAMSON confirms the update by attaching the assigned test mark (stamp).

10.5 Periodic inspection and testing of the positioner

We recommend inspection and testing according to Table 10-1 at the minimum.

Table 10-1: *Recommended inspection and testing*

Inspection and testing	Action to be taken in the event of a negative result
Check the markings, labels and nameplates on the positioner for their readability and completeness.	Immediately renew damaged, missing or incorrect nameplates or labels.
	Clean any inscriptions that are covered with dirt and are illegible.
Check the positioner and leakage sensor (if installed) to ensure they are mounted firmly.	Tighten the any loose mounting screws.
Check the pneumatic connections.	Tighten any loosen male connectors of the screw fittings.
	Renew any air pipes or hoses that leak.
Check the power lines.	Tighten any loose cable glands.
	Make sure that the stranded wires are pushed into the terminals and tighten any loose screws on the the terminals.
	Renew damaged lines.
Check error messages on the display (indicated by the  and  icons).	Troubleshooting (see the 'Malfunction' chapter).

11 Decommissioning

The work described in this chapter is only to be performed by personnel appropriately qualified to carry out such tasks.

⚠ DANGER

Risk of fatal injury due to ineffective explosion protection.

The explosion protection becomes ineffective when the positioner cover is opened.

→ *The following regulations apply to installation in hazardous areas: EN 60079-14 (VDE 0165, Part 1).*

ⓘ NOTICE

The process is disturbed by interrupting closed-loop control.

→ *Do not mount or service the positioner while the process is running and only after isolating the plant by closing the shut-off valves.*

To decommission the positioner before removing it, proceed as follows:

- Put the control valve out of operation. See associated valve documentation.
- Shut off and lock the supply air line to the positioner.
- Disconnect and lock the electrical supply.

12 Removal

The work described in this chapter is only to be performed by personnel appropriately qualified to carry out such tasks.

DANGER

Risk of fatal injury due to the ignition of an explosive atmosphere.

- *The following regulations apply to installation in hazardous areas: EN 60079-14 (VDE 0165, Part 1).*
 - *Installation, operation or maintenance of the positioner must only be performed by personnel who has undergone special training or instructions or who is authorized to work on explosion-protected devices in hazardous areas.*
-
- Put the positioner out of operation (see the 'Decommissioning' chapter).
 - Disconnect the wires for electrical input and remove them from the positioner.
 - Unscrew the screw fittings at the Output 38 and Supply 9 ports of the positioner.
 - To remove the positioner, loosen the three fastening screws on the positioner.

13 Repairs

A defective positioner must be repaired or replaced.

! NOTICE

Risk of positioner damage due to incorrect service or repair work.

- Do not perform any repair work on your own.
- Contact SAMSON's After-sales Service for repair work.

13.1 Servicing explosion-protected devices

If a part of the device on which the explosion protection is based needs to be serviced, the device must not be put back into operation until a qualified inspector has assessed it according to explosion protection requirements, has issued an inspection certificate, or given the device a mark of conformity. Inspection by a qualified inspector is not required if the manufacturer performed a routine test on the device before putting it back into operation. Document the passing of the routine test by attaching a mark of conformity to the device.

Replace explosion-protected components only with original, routine-tested components by the manufacturer.

Devices that have already been used outside hazardous areas and are intended for future use inside hazardous areas must comply with the safety requirements placed on serviced devices. Before being operated inside hazardous areas, test the devices according to the specifications for servicing explosion-protected devices.

EN 60079-19 applies to servicing explosion-protected devices.

13.2 Returning devices to SAMSON

Defective devices can be returned to SAMSON for repair.

Proceed as follows to return devices to SAMSON:

1. Put the positioner out of operation (see the 'Decommissioning' chapter).
2. Remove the positioner (see the 'Removal' chapter).
3. Proceed as described on the Returning goods page of our website
 - ▶ www.samsongroup.com > Service > After-sales Service > Returning goods

14 Disposal



We are registered with the German national register for waste electric equipment (stiftung ear) as a producer of electrical and electronic equipment, WEEE reg. no.: DE 62194439

- Observe local, national and international refuse regulations.
- Do not dispose of components, lubricants and hazardous substances together with your other household waste.



On request, we can appoint a service provider to dismantle and recycle the product.

15 Certificates

The following certificate is shown on the next page:

- EU declaration of conformity for Type 3730-6
- EU declaration of conformity for Type 3730-6-110 and -210
- EU declaration of conformity for Type 3730-6-810
- EAC certificate for Type 3730-6
- EAC certificate for Type 3730-6-113, -213 and -813
- ATEX: statement of conformity
- ATEX: EU type examination certificate
- IECEx: IECEx certificate of conformity for Type 3730-6-111, -211 and -511
- IECEx: IECEx certificate of conformity for Type 3730-6-811
- CSA certificate
- FM certificate

The certificates shown were up to date at the time of publishing. The latest certificates can be found on our website:

► www.samsongroup.com > Products > Valve accessories > 3730-6



**EU Konformitätserklärung / EU Declaration of Conformity /
Déclaration UE de conformité**

Die alleinige Verantwortung für die Ausstellung dieser Konformitätserklärung trägt der Hersteller/
This declaration of conformity is issued under the sole responsibility of the manufacturer/
La présente déclaration de conformité est établie sous la seule responsabilité du fabricant.
Für das folgende Produkt / For the following product / Nous certifions que le produit

**Elektropneumatischer Stellungsregler mit HART-Kommunikation /
Electropneumatic Positioner with HART communication /
Positionneur électropneumatique avec communication HART
Typ/Type/Type 3730-6...**

wird die Konformität mit den einschlägigen Harmonisierungsrechtsvorschriften der Union bestätigt /
the conformity with the relevant Union harmonisation legislation is declared with/
est conforme à la législation d'harmonisation de l'Union applicable selon les normes:

EMC 2014/30/EU	EN 61000-6-2:2005, EN 61000-6-3:2007 +A1:2011, EN 61326-1:2013
RoHS 2011/65/EU	EN 50581:2012

Hersteller / Manufacturer / Fabricant:

SAMSON AKTIENGESELLSCHAFT
Weismüllerstraße 3
D-60314 Frankfurt am Main
Deutschland/Germany/Allemagne

Frankfurt / Francfort, 2017-07-29

Im Namen des Herstellers/ On behalf of the Manufacturer/ Au nom du fabricant.

Hanno Zager
Leiter Qualitätssicherung/Head of Quality Management/
Responsable de l'assurance de la qualité

Dirk Hoffmann
Zentralabteilungsleiter/Head of Department/Chef du département
Entwicklungsorganisation/Development Organization

EU Konformitätserklärung / EU Declaration of Conformity / Déclaration UE de conformité

Die alleinige Verantwortung für die Ausstellung dieser Konformitätserklärung trägt der Hersteller/
This declaration of conformity is issued under the sole responsibility of the manufacturer/
La présente déclaration de conformité est établie sous la seule responsabilité du fabricant.
Für das folgende Produkt / For the following product / Nous certifions que le produit

Elektropneumatischer Stellungsregler mit HART-Kommunikation / Electropneumatic Positioner with HART communication / Positionneur électropneumatique avec communication HART Typ/Type/Type 3730-6-110 und -210

entsprechend der EU-Baumusterprüfbescheinigung PTB 10 ATEX 2007 ausgestellt von der/
according to the EU Type Examination PTB 10 ATEX 2007 issued by/
établi selon le certificat CE d'essais sur échantillons PTB 10 ATEX 2007 émis par:

Physikalisch Technische Bundesanstalt
Bundesallee 100
D-38116 Braunschweig
Benannte Stelle/Notified Body/Organisme notifié 0102

wird die Konformität mit den einschlägigen Harmonisierungsrechtsvorschriften der Union bestätigt /
the conformity with the relevant Union harmonisation legislation is declared with/
est conforme à la législation d'harmonisation de l'Union applicable selon les normes:

EMC 2014/30/EU	EN 61000-6-2:2005, EN 61000-6-3:2007 +A1:2011, EN 61326-1:2013
Explosion Protection 94/9/EC (bis/to 2016-04-19) Explosion Protection 2014/34/EU (ab/from 2016-04-20)	EN 60079-0:2009, EN 60079-11:2012, EN 60079-31:2009
RoHS 2011/65/EU	EN 50581:2012

Hersteller / Manufacturer / Fabricant:

SAMSON AKTIENGESELLSCHAFT
Weismüllerstraße 3
D-60314 Frankfurt am Main
Deutschland/Germany/Allemagne

Frankfurt / Francfort, 2017-07-29

Im Namen des Herstellers/ On behalf of the Manufacturer/ Au nom du fabricant.

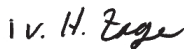

Hanno Zager
Leiter Qualitätssicherung/Head of Quality Management/
Responsable de l'assurance de la qualité

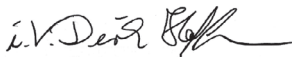

Dirk Hoffmann
Zentralabteilungsleiter/Head of Department/Chef du département
Entwicklungsorganisation/Development Organization



EU Konformitätserklärung / EU Declaration of Conformity / Déclaration UE de conformité

Die alleinige Verantwortung für die Ausstellung dieser Konformitätserklärung trägt der Hersteller/
This declaration of conformity is issued under the sole responsibility of the manufacturer/
La présente déclaration de conformité est établie sous la seule responsabilité du fabricant.
Für das folgende Produkt / For the following product / Nous certifions que le produit

Elektropneumatischer Stellungsregler mit HART-Kommunikation / Electropneumatic Positioner with HART communication / Positionneur électropneumatique avec communication HART Typ/Type/Type 3730-6-810

entsprechend der EU-Baumusterprüfbescheinigung PTB 10 ATEX 2008 X ausgestellt von der/
according to the EU Type Examination PTB 10 ATEX 2008 X issued by/
établi selon le certificat CE d'essais sur échantillons PTB 10 ATEX 2008 X émis par:

Physikalisch Technische Bundesanstalt
Bundesallee 100
D-38116 Braunschweig
Benannte Stelle/Notified Body/Organisme notifié 0102

wird die Konformität mit den einschlägigen Harmonisierungsrechtsvorschriften der Union bestätigt /
the conformity with the relevant Union harmonisation legislation is declared with/
est conforme à la législation d'harmonisation de l'Union applicable selon les normes:

EMC 2014/30/EU

EN 61000-6-2:2005, EN 61000-6-3:2007
+A1:2011, EN 61326-1:2013

Explosion Protection 94/9/EC (bis/to 2016-04-19)
Explosion Protection 2014/34/EU (ab/from 2016-04-20)

EN 60079-0:2009, EN 60079-11:2012,
EN 60079-15:2010, EN 60079-31:2009

RoHS 2011/65/EU

EN 50581:2012

Hersteller / Manufacturer / Fabricant:

SAMSON AKTIENGESELLSCHAFT
Weismüllerstraße 3
D-60314 Frankfurt am Main
Deutschland/Germany/Allemagne

Frankfurt / Francfort, 2017-07-29

Im Namen des Herstellers/ On behalf of the Manufacturer/ Au nom du fabricant.

H. Zager

Hanno Zager
Leiter Qualitätssicherung/Head of Quality Management/
Responsable de l'assurance de la qualité

D. Hoffmann

Dirk Hoffmann
Zentralabteilungsleiter/Head of Department/Chef de département
Entwicklungsorganisation/Development Organization

ЕВРАЗИЙСКИЙ ЭКОНОМИЧЕСКИЙ СОЮЗ



СЕРТИФИКАТ СООТВЕТСТВИЯ

№ ЕАЭС RU C-DE.ЭА11.В.00045/19

Серия RU № 0197354

ОРГАН ПО СЕРТИФИКАЦИИ Общества с ограниченной ответственностью «ТМС РУС».
Место нахождения (адрес юридического лица): Российская Федерация, 127083, город Москва, улица Верхняя Масловка, дом 20, строение 2; адрес места осуществления деятельности: Российская Федерация, 127083, город Москва, улица Верхняя Масловка, дом 20, строение 2, помещения № 18, 28. Аттестат аккредитации № РОСС RU.0001.11ЭА11 от 02.07.2015. Номер телефона: +7 (495) 221-18-04; адрес электронной почты: info@tms-cs.ru.

ЗАЯВИТЕЛЬ Общество с ограниченной ответственностью «Самсон Контролс».
Место нахождения (адрес юридического лица) и адрес места осуществления деятельности: Российская Федерация, 109544, город Москва, бульвар Энтузиастов, дом 2, этаж 5, комната 11. ОГРН 1037700041026. Номер телефона: +7 (495) 777-45-45; адрес электронной почты: samson@samson.ru.

ИЗГОТОВИТЕЛЬ «SAMSON AG Mess- und Regeltechnik».
Место нахождения (адрес юридического лица) и адрес места осуществления деятельности по изготовлению продукции: Weismüllerstrasse 3, D-60314 Frankfurt am Main, Германия.

ПРОДУКЦИЯ Позиционеры, типы 3724, 3725, 3730-0, 3730-1, 3730-2, 3730-3, 3730-4, 3730-5, 3730-6, 3731-3, 3731-5, 4763, 4765. Изготовление в соответствии со стандартами, указанными в приложении к сертификату соответствия на бланке № 0676628.
Серийный выпуск.

КОД ТН ВЭД ЕАЭС 9032 81 000 0

СООТВЕТСТВУЕТ ТРЕБОВАНИЯМ технического регламента Таможенного союза «Электромагнитная совместимость технических средств» (ТР ТС 020/2011)

СЕРТИФИКАТ СООТВЕТСТВИЯ ВЫДАН НА ОСНОВАНИИ протокола сертификационных испытаний № 190919-013-016-02/ИР от 22.10.2019, выданного испытательной лабораторией Общества с ограниченной ответственностью «Иновационные решения», аттестат аккредитации РОСС RU.0001.21AB90; акта о результатах анализа состояния производства № 00062-А от 04.07.2019 органа по сертификации Общества с ограниченной ответственностью «ТМС РУС»; руководств по эксплуатации 4218-3725-3724-2018.РЭ, 4218-3730-4763-2018.РЭ, 4218-3731-2018.РЭ.
Схема сертификации – 1с.

ДОПОЛНИТЕЛЬНАЯ ИНФОРМАЦИЯ Стандарт, в результате применения которого на добровольной основе обеспечивается соблюдение требований технического регламента: подразделы 6.2 и 7.2 ГОСТ Р 51522.1-2011 (МЭК 61326-1:2005) «Электрическое оборудование для измерения, управления и лабораторного применения. Часть 1. Общие требования и методы испытаний». Назначенный срок службы – 15 лет. Назначенный срок хранения – 2 года. Условия хранения указаны в руководствах по эксплуатации 4218-3725-3724-2018.РЭ, 4218-3730-4763-2018.РЭ, 4218-3731-2018.РЭ.

СРОК ДЕЙСТВИЯ С 05.11.2019

ПО 04.11.2024

ВКЛЮЧИТЕЛЬНО

Руководитель (уполномоченное лицо) органа по сертификации

Эксперт (эксперт-аудитор)
(эксперты (эксперты-аудиторы))

Назарова
(подпись)

Ходоров
(подпись)



Назарова Лилия Юрьевна

(ф.и.о.)

Ходоров Владимир Игоревич

(ф.и.о.)

ПРИЛОЖЕНИЕ

К СЕРТИФИКАТУ СООТВЕТСТВИЯ № ЕАЭС RU C-DE.ЭА11.В.00045/19

Серия RU № 0676628 Лист 1 из 1

Стандарты, в соответствии с которыми изготавливается продукция

Обозначение стандарта	Наименование стандарта
IEC 61000-6-2:2016	Electromagnetic compatibility (EMC). Part 6-2: Generic standards. Immunity for industrial environments
EN 61000-6-3:2007	Electromagnetic compatibility (EMC). Part 6-3: Generic standards. Emission standard for residential, commercial and light-industrial environments
EN 61326-1:2013	Electrical equipment for measurement, control and laboratory use. EMC requirements. Part 1: General requirements

Руководитель (уполномоченное лицо) органа по сертификации

(подпись)

Эксперт (эксперт-аудитор) (эксперты (эксперты-аудиторы))

(подпись)



Назарова Лилия Юрьевна (Ф.И.О.)

Ходоров Владимир Игоревич (Ф.И.О.)

СЕРТИФИКАТ СООТВЕТСТВИЯ



№ ТС RU C-DE.AA87.B.01278

Серия RU № 0743927

ОРГАН ПО СЕРТИФИКАЦИИ Орган по сертификации взрывозащищенного и рудничного оборудования (ОС ЦСВЭ) Общества с ограниченной ответственностью «Центр по сертификации взрывозащищенного и рудничного оборудования» (ООО «НАНИО ЦСВЭ»). Адрес места нахождения юридического лица: Россия, 140004, Московская область, Люберецкий район, город Люберцы, поселок ВУТИ, АО «Завод «ЭКОМАШ», литера В, Объект 6, этаж 3, офис 26. Адрес места осуществления деятельности в области аккредитации: Россия, 140004, Московская область, Люберецкий район, город Люберцы, поселок ВУТИ, АО «Завод «ЭКОМАШ», Литера В, Объект 6, этаж 3, офисы 26/3, 26/4, 26/5, 27/6, 30/1, 32. Аттестат № RA.RU.11AA87 от 20.07.2015 г. Телефон: +7 (495) 558-83-53, +7 (495) 558-82-44. Адрес электронной почты: ceve@ceve.ru

ЗАЯВИТЕЛЬ Общество с ограниченной ответственностью «Самсон Контролс», Россия, 109147, Москва, ул. Марксистская, д. 16. ОГРН: 1037700041026. Телефон: +7 (495) 7774545. Адрес электронной почты: samson@samson.ru

ИЗГОТОВИТЕЛЬ SAMSON AG Mess- und Regeltechnik, Weismüllerstrasse 3, 60314 Frankfurt am Main, Германия.

ПРОДУКЦИЯ Позиционеры типов 3730-01, 3730-11, 3730-31, 3730-6-113, 3730-08, 3730-18, 3730-38, 3730-6-813, 3730-6-213 с электропреобразователем (барьером) типа 3770-1 (выпускаются в соответствии с технической документацией SAMSON AG Mess- und Regeltechnik на позиционеры типов 3730-01, 3730-11, 3730-31, 3730-6-113, 3730-08, 3730-18, 3730-38, 3730-6-813, 3730-6-213 с электропреобразователем (барьером) типа 3770-1) с Ех-маркировками согласно приложению (см. бланки №№ 0550180, 0550181, 0550182, 0550183). Серийный выпуск.

КОД ТН ВЭД ТС 9032 810000

СООТВЕТСТВУЕТ ТРЕБОВАНИЯМ ТР ТС 012/2011 «О безопасности оборудования для работы во взрывоопасных средах».

СЕРТИФИКАТ ВЫДАН НА ОСНОВАНИИ Протокола оценки и испытаний № 227.2018-Т от 29.11.2018 Испытательной лаборатории взрывозащищенного и рудничного оборудования (ИЛ ЦСВЭ) Общества с ограниченной ответственностью «Центр по сертификации взрывозащищенного и рудничного оборудования» (ООО «НАНИО ЦСВЭ») (аттестат № RA.RU.21AK06 от 19.01.2016); Акта о результатах анализа состояния производства сертифицируемой продукции № 151-А/18 от 10.10.2018 Органа по сертификации взрывозащищенного и рудничного оборудования (ОС ЦСВЭ) Общества с ограниченной ответственностью «Центр по сертификации взрывозащищенного и рудничного оборудования» (ООО «НАНИО ЦСВЭ») (аттестат № RA.RU.11AA87 выдан 20.07.2015).
Схема сертификации – 1с.

ДОПОЛНИТЕЛЬНАЯ ИНФОРМАЦИЯ

Перечень стандартов – см. приложение, бланк № 0550183.
Условия и срок хранения указаны в технической документации.
Назначенный срок службы – 15 лет.

СРОК ДЕЙСТВИЯ С 30.11.2018 ПО 29.11.2023 ВКЛЮЧИТЕЛЬНО



Руководитель (уполномоченное лицо) органа по сертификации

Эксперт (эксперт-аудитор) (эксперты (эксперты-аудиторы))

[Подпись]
(подпись)

[Подпись]
(подпись)

Коган Алексей Александрович
(инициалы, фамилия)

Мозеров Валентин Алексеевич
(инициалы, фамилия)

ПРИЛОЖЕНИЕ

К СЕРТИФИКАТУ СООТВЕТСТВИЯ № ТС RU C-DE.AA87.B.01278 Лист 1

Серия RU № 0550180

1. НАЗНАЧЕНИЕ И ОБЛАСТЬ ПРИМЕНЕНИЯ

Позиционеры типов 3730-01, 3730-11, 3730-31, 3730-6-113, 3730-08, 3730-18, 3730-38, 3730-6-813, 3730-6-213 с электропреобразователем (барьером) типа 3770-1 (далее – позиционеры) предназначены для преобразования электрического входного сигнала в пропорциональный пневматический выходной сигнал и выдачи токового или цифрового сигнала положения клапана.

Область применения – взрывоопасные зоны помещений и наружных установок, а также зоны, опасные по воспламенению горючей пыли, согласно Ех-маркировке, ГОСТ IEC 60079-14-2013, регламентирующим применение электрооборудования во взрывоопасных средах.

2. ОСНОВНЫЕ ТЕХНИЧЕСКИЕ ДАННЫЕ

2.1. Ех-маркировка:		
- позиционеры типов 3730-01		1Ex ia IIC T6...T4 Gb Ex ia IIIС T80°C Db или Ex ib IIIС T80°C Db
- позиционеры типов 3730-08		2Ex nA II T6...T4 Gc X Ex tc IIIС T80°C Dc X
- позиционеры типов 3730-11		1Ex ia IIC T6...T4 Gb Ex ia IIIС T80°C Db или Ex ib IIIС T80°C Db
- позиционеры типов 3730-18		2Ex nA IIC T6...T4 Gc X Ex tc IIIС T80°C Dc X
- позиционеры типов 3730-31		1Ex ia IIC T6...T4 Gb Ex ia IIIС T80°C Db или Ex ib IIIС T80°C Db
- позиционеры типов 3730-38		2Ex ic IIC T6...T4 Gc или 2Ex nA IIC T6...T4 Gc X Ex tc IIIС T80°C Dc X
- позиционеры типов 3730-6-113		1Ex ia IIC T6...T4 Gb Ex ia IIIС T80°C Db или Ex ib IIIС T80°C Db
3730-6-213 с электропреобразователем (барьером) типа 3770-1		1Ex d [ia] IIC T6...T4 Gb X Ex ib IIIС T80°C Db X
- позиционеры типов 3730-6-813		2Ex nA IIC T6...T4 Gc X 2Ex ic IIC T6...T4 Gc или Ex tc IIIС T80°C Dc
2.2. Диапазон температур окружающей среды, °С:		
- позиционеры типов 3730-6-113, 3730-6-213:		
для I _п = 52мА		от минус 55 до +45(Т6)+60(Т5)+75(Т4)
для I _п = 25мА		от минус 55 до +60(Т6)+80(Т5)+80(Т4)
- позиционеры типов 3730-1		от минус 40 до +50(Т6)+70(Т5)+80(Т4)
- позиционеры типов 3730-11:		
для I _п = 52мА		от минус 40 до +45(Т6)+60(Т5)+75(Т4)
для I _п = 25мА		от минус 40 до +60(Т6)+80(Т5)+80(Т4)
- позиционеры типов 3730-31:		
для I _п = 52мА		от минус 55 до +45(Т6)+60(Т5)+75(Т4)
для I _п = 25мА		от минус 55 до +60(Т6)+80(Т5)+80(Т4)
- позиционеры типов 3730-08		от минус 40 до +50(Т6)+70(Т5)+80(Т4)
- позиционеры типов 3730-18		от минус 40 до +60(Т6)+70(Т5)+80(Т4)
- позиционеры типов 3730-38		от минус 55 до +60(Т6)+70(Т5)+80(Т4)
- позиционеры типов 3730-6-813:		
для I _п = 52мА		от минус 55 до +45(Т6)+60(Т5)+75(Т4)
для I _п = 25мА		от минус 55 до +60(Т6)+80(Т5)+80(Т4)
- электропреобразователь типа 3770-1		от минус 45 до +60
2.3. Степень защиты от внешних воздействий:		
- позиционеры с Ех-маркировкой 2Ex nA II T6...T4 Gc X		не ниже IP54
- все остальные позиционеры		IP65, IP66



Руководитель (уполномоченное лицо) органа по сертификации
Эксперт-аудитор (эксперт)

[Signature]
подпись

Коган Алексей Александрович

инициалы, фамилия

Мозеров Валентин Алексеевич

инициалы, фамилия

ПРИЛОЖЕНИЕ

К СЕРТИФИКАТУ СООТВЕТСТВИЯ № ТС RU C-DE.AA87.B.01278 Лист 2

Серия RU № 0550181

2.4. Входные и выходные искробезопасные параметры позиционеров с Ex-маркировкой IEx ia IIC T6...T4 Gb, Ex ia IIC T80°C Db:		Входные искробезопасные параметры						Выходные искробезопасные параметры					
Типы позиционеров	Клеммы	U _i , * В	I _i , * mA	P _i , * Вт	L _i , мГн	C _i , нФ	U _o , В	I _o , mA	P _o , мВт	L _o , мГн	C _o , нФ		
		3730-6-113, 3730-6-213	11/12	28/32	115/87	1	0	5,3	-	-	-	-	-
	31/32	28/32	115/87,5	1	0	5,3	-	-	-	-	-		
		30	100	-	0	56,3	-	-	-	-	-		
	41/42	16	52/25	0,169/0,064	100	30	-	-	-	-	-		
	41/42 и 51/52	20	60	0,25	0	5,3	-	-	-	-	-		
	81/82	28/32	115/87,5	-	0	5,3	-	-	-	-	-		
	83/84	20	60	0,25	0	5,3	-	-	-	-	-		
	Интерфейс SSP	20	60	0,2	0	0	7,88	69,2	137	10	650		
	Датчик положения	-	-	-	370	66	7,88	13,2	27	10	1000		
3730-01	11/12	28	115	1	0	5,3	-	-	-	-	-		
3730-11	11/12	28	115	1	0	6	-	-	-	-	-		
	44/45	16	52/25	0,169/0,064	100	30	-	-	-	-	-		
	41/42 и 51/52	20	60	0,25	0	16	-	-	-	-	-		
3730-31	11/12	28	115	1	0	35	-	-	-	-	-		
	31/32	28	115	1	0	5,3	-	-	-	-	-		
		30	100	0,25	0	56,3	-	-	-	-	-		
		30	100	-	0	5,3	-	-	-	-	-		
	41/42	16	52/25	0,169/0,064	100	30	-	-	-	-	-		
	41/42 и 51/52	20	60	0,25	0	5,3	-	-	-	-	-		
	81/82	28	115	-	0	5,3	-	-	-	-	-		
	83/84	20	60	0,25	0	5,3	-	-	-	-	-		
	Интерфейс BU	16	25	0,064	0	0	7,88	61,8	120	10	650		
	Датчик положения	-	-	-	370	730	7,88	61	120	10	660		
2.5. Входные и выходные искробезопасные параметры позиционеров с Ex-маркировкой 2Ex ic IIC T6...T4 Gc X, Ex ic IIC T80°C Dc X													
Типы позиционеров	Клеммы	Входные искробезопасные параметры						Выходные искробезопасные параметры					
		U _i , * В	I _i , * mA	P _i , * Вт	L _i , мГн	C _i , нФ	U _o , В	I _o , mA	P _o , мВт	L _o , мГн	C _o , нФ		
3730-08	11/12	28	115	1	0	5,3	-	-	-	-	-		
		28	115	1	0	5,3	-	-	-	-	-		
3730-18	11/12	28	115	1	0	6	-	-	-	-	-		
		44/45	20	52/25	0,169/0,064	100	30	-	-	-	-		
3730-38	41/42 и 51/52	20	60	0,25	0	16	-	-	-	-	-		
		11/12	30	100	1	0	35	-	-	-	-		
	31/32	28/30	115/100	1	0	5,3	-	-	-	-	-		
		30	100	0,25	0	56,3	-	-	-	-	-		
			-	-	-	0	5,3	-	-	-	-		
		41/42	20	52/25	0,169/0,064	100	30	-	-	-	-		
		41/42 и 51/52	20	60	0,4	0	5,3	-	-	-	-		
		81/82	30	100	-	0	5,3	-	-	-	-		
		83/84	20	60	0,4	0	5,3	-	-	-	-		
		Интерфейс BU	20	25	0,064	0	0	7,88	62	120	10	650	
		Датчик положения	-	-	-	370	730	7,88	61	120	10	660	
	3730-6-813	11/12	32	132	1,2	0	5,3	-	-	-	-	-	
31/32			32	132	1	0	56,3	-	-	-	-		
41/42		20	52/25	0,169/0,064	100	30	-	-	-	-	-		
		20	60	0,4	0	5,3	-	-	-	-	-		
81/82		32	132	-	0	5,3	-	-	-	-	-		
		20	60	0,4	0	5,3	-	-	-	-	-		
83/84		20	60	0,4	0	5,3	-	-	-	-	-		
		20	60	0,2	0	5,3	-	-	-	-	-		
	Интерфейс SSP	7,88	61	0,12	10000	1000	-	-	-	-			
	Датчик положения	-	-	-	-	-	-	-	-	-			



* конкретные значения U_i, I_i, P_i определяются из максимально допустимой входной мощности P_i* и не могут действовать на вход позиционеров одновременно.

Руководитель (уполномоченное лицо) органа по сертификации
Эксперт-аудитор (эксперт)

[Подпись] Коган Алексей Александрович
инициалы, фамилия
[Подпись] Мозеров Валентин Алексеевич
инициалы, фамилия

ПРИЛОЖЕНИЕ

К СЕРТИФИКАТУ СООТВЕТСТВИЯ № ТС RU C-DE.AA87.B.01278 Лист 3

Серия RU № 0550183

2.6. Электрические параметры позиционеров с Ex-маркировкой 2Ex nA ПС Т6...Т4 Ge X

Цепь	Клеммы	Номинальное напряжение постоянного тока U _п , В	Ток, мА
	11/12	-	4...20
Датчик положения	31/32	-	4...20
Концевой датчик	41/42	8	8
Программное обеспечение	41/42 и 51/52	8	8
Магнитный клапан	81/82	6...24	-
Индикация ошибок	83/84	8	8
Датчик положения (оммический)	-	6...30	-

2.7. Электрические параметры позиционеров 3730-6-213 с электропреобразователем (барьером) типа 3770-1 с Ex-маркировкой IEx d [ia] ПС/ПВ Т6 Gb X, Ex tb ПС Т30°C Db X:

- максимальное напряжение переменного тока U _m , В	250
- номинальный ток, мА	80
- выходной сигнал	4-20 мА

2.8. Выходные искробезопасные параметры электропреобразователя типа 3770-1:

Цепь	Клеммы	U ₀ , В	I ₀ , мА	P ₀ , мВт	L ₀ , мГн	C ₀ , мкФ
Канал 1	+/-	17,2	110	473	3	360
Канал 2, 3	+/-	12,6	49	154	15	1,15

3. ОПИСАНИЕ КОНСТРУКЦИИ И ОБЕСПЕЧЕНИЯ ВЗРЫВОЗАЩИЩЕННОСТИ ИЗДЕЛИЙ

Позиционеры типов 3730-6-113, 3730-6-213, 3730-6-813 выполнены в прямоугольном корпусе, изготовленного из нержавеющей стали или из алюминиевого сплава с содержанием магния, цинка и никония менее 7,5%. На одной боковой стороне поверхности корпуса имеются отверстия под кабельные вводы, на другой – фитинги пневматической системы. Внутри корпусов позиционеров размещены электронные платы схем управления. На корпусе имеется заземляющий зажим и маркировочная табличка.

Позиционеры типов 3730-01, 3730-11, 3730-31, 3730-08, 3730-18, 3730-38 выполнены в виде единого блока, состоящего из корпуса и крышки. Внутри корпуса расположена электронная плата IP преобразователя, элементы для подключения электрических и пневматических линий. На корпусе имеются отверстия под кабельные вводы.

Электропреобразователь типа 3770-1 представляет собой электронную схему многоканального барьера искрозащиты, помещенную в цилиндрический корпус из алюминиевого сплава с содержанием магния, цинка и никония менее 7,5%. На корпусе имеются отверстия под кабельные вводы, наружный и внутренний заземляющие зажимы.

Взрывозащищенность позиционеров обеспечивается выполнением требований стандартов: ГОСТ 31610.11-2014 (IEC 60079-11:2011). Взрывоопасные среды. Часть 11. Оборудование с видом взрывозащиты искробезопасная электрическая цепь «и»; ГОСТ 31610.15-2012/МЭК 60079-15:2005. Электрооборудование для взрывоопасных газовых сред. Часть 15. Конструкция, испытания и маркировка электрооборудования с видом защиты «и». ГОСТ 31610.0-2014 (IEC 60079-0:2011). Взрывоопасные среды. Часть 0. Оборудование. Общие требования. ГОСТ IEC 60079-1-2011 Взрывоопасные среды. Часть 1. Оборудование с видом взрывозащиты «взрывонепроницаемые оболочки «д», ГОСТ IEC 60079-31-2010 Взрывоопасные среды. Часть 31. Оборудование с защитой от воспламенения пыли оболочками «и» согласно Ex-маркировке, приведенной в п.2.1.

4. МАРКИРОВКА

Ex-маркировка, наносимая на позиционеры, должна включать следующие данные:

- товарный знак или наименование предприятия - изготовителя;
- тип изделия;
- заводской номер;
- Ex-маркировку;
- специальный знак взрывобезопасности;
- предупредительные надписи;
- наименование или знак центра по сертификации и номер сертификата соответствия;



Руководитель (уполномоченное лицо) органа по сертификации
Эксперт-аудитор (эксперт)

[Handwritten signature]
подпись

Коган Алексей Александрович
инициалы, фамилия

Мозеров Валентин Алексеевич
инициалы, фамилия



(1) **EU-TYPE EXAMINATION CERTIFICATE**
(Translation)

(2) Equipment or Protective Systems Intended for Use in Potentially Explosive Atmospheres - **Directive 2014/34/EU**

(3) EU-Type Examination Certificate Number:

PTB 10 ATEX 2007

Issue: 1

(4) Product: Digital positioner, type 3730-6-110..., 3730-6-510... and 3730-6-210... with HART communication

(5) Manufacturer: **SAMSON AG**

(6) Address: **Weismüllerstraße 3, 60314 Frankfurt, Germany**

(7) This product and any acceptable variation thereto is specified in the schedule to this certificate and the documents therein referred to.

(8) The Physikalisch-Technische Bundesanstalt, notified body No. 0102 in accordance with Article 17 of the Directive 2014/34/EU of the European Parliament and of the Council, dated 26 February 2014, certifies that this product has been found to comply with the Essential Health and Safety Requirements relating to the design and construction of products intended for use in potentially explosive atmospheres, given in Annex II to the Directive.

The examination and test results are recorded in the confidential Test Report PTB Ex 19-25143.

(9) Compliance with the Essential Health and Safety Requirements has been assured by compliance with:

EN 60079-0:2018 EN 60079-11:2012 EN 60079-31:2014

(10) If the sign "X" is placed after the certificate number, it indicates that the product is subject to the Specific Conditions of Use specified in the schedule to this certificate.

(11) This EU-Type Examination Certificate relates only to the design and construction of the specified product in accordance to the Directive 2014/34/EU. Further requirements of the Directive apply to the manufacturing process and supply of this product. These are not covered by this certificate.

(12) The marking of the product shall include the following:

 **II 2G Ex ia IIC T6 Gb and II 2D Ex ia IIIC T80 °C Db,**
II 2G Ex db [ia] IIC T6 Gb and II 2D Ex tb IIIC T80 °C Db,
II 2D Ex tb IIIC T80 °C Db

Konformitätsbewertungsstelle, Sektor Explosionsschutz

Braunschweig, January 20, 2020

On behalf of PTB

Dr.-Ing. F. Lienisch
Direktor und Professor



sheet 1/9

EU-Type Examination Certificates without signature and official stamp shall not be valid. The certificates may be circulated only without alteration. Extracts or alterations are subject to approval by the Physikalisch-Technische Bundesanstalt. In case of dispute, the German text shall prevail.

Physikalisch-Technische Bundesanstalt • Bundesallee 100 • 38116 Braunschweig • GERMANY

SCHEDULE

(13)

(14) **EU-Type Examination Certificate Number PTB 10 ATEX 2007, Issue: 1**

(15) Description of Product

The digital positioner with HART communication is a single or double acting positioner. It is used for the conversion of electrical actuating signals into pneumatic actuating pressure signals.

The equipment is installed inside the hazardous area.

The equipment is available in three designs, type 3730-6-110... with an intrinsic safe supply, type 3730-6-210... with a field barrier connected in series and type 3730-6-510.

Marking

Type 3730-6-110



II 2 G Ex ia IIC T6 Gb and



II 2 D Ex ia IIIC T80 °C Db

Type 3730-6-210 with field barrier, type 3770-1



II 2 G Ex db [ia] IIC T6 Gb and



II 2 D Ex tb IIIC T80 °C Db

Typ 3730-6-510:



II 2 D Ex tb IIIC T80 °C Db

For relationship between type of protection, temperature class, options and permissible ambient temperature range, reference is made to the table:

Type of protection / Options	Permissible ambient temperature range
Ex ia IIC T6	60 °C
Ex ia IIC T5	-55 °C ... 70 °C
Ex ia IIC T4	80 °C
Ex ia IIIC	-55 °C ... 80 °C
Option, structure-borne sound sensor	60 °C
	-40 °C ... 70 °C
	80 °C

sheet 2/9

EU-Type Examination Certificates without signature and official stamp shall not be valid. The certificates may be circulated only without alteration. Extracts or alterations are subject to approval by the Physikalisch-Technische Bundesanstalt. In case of dispute, the German text shall prevail.

Physikalisch-Technische Bundesanstalt • Bundesallee 100 • 38116 Braunschweig • GERMANY

SCHEDULE TO EU-TYPE EXAMINATION CERTIFICATE PTB 10 ATEX 2007, Issue: 1

Regarding type of protection „tb“

Dust group	Max. surface temperature	Permissible ambient temperature range
IIIC	T 80 °C	-40 °C ... 70 °C

Electrical data

Type 3730-6-210 with field barrier, type 3770-1 connected in series

Operating values: 4 ... 20 mA
 Supply circuit $U_n = 10 \text{ V}$
 or NAMUR-limit contact $U_m = 250 \text{ V}$

Type 3730-6-110

The positioner may be connected to certified intrinsically safe circuits provided the permissible maximum values for U_i , I_i and P_i are not exceeded.

The circuits for the voltage/power supply, the serial SSP interface and the external position sensor are operationally interconnected and safely electrically isolated from the other intrinsically safe circuits up to a peak value of the nominal voltage of 60 V. The intrinsically safe circuits are safely electrically isolated from each other up to a peak value of the nominal voltage of 60 V. All circuits are safely isolated from ground.

sheet 3/9

EU-Type Examination Certificates without signature and official stamp shall not be valid. The certificates may be circulated only without alteration. Extracts or alterations are subject to approval by the Physikalisch-Technische Bundesanstalt. In case of dispute, the German text shall prevail.

Physikalisch-Technische Bundesanstalt • Bundesallee 100 • 38116 Braunschweig • GERMANY



SCHEDULE TO EU-TYPE EXAMINATION CERTIFICATE PTB 10 ATEX 2007, Issue: 1

Operating values: 4 ... 20 mA

Voltage/power supply type of protection Ex ia IIC/IIB/IIIC
(terminals 11/12) only for connection to a certified
intrinsically safe circuit

Maximum values:

$U_i = 28 \text{ V}$
 $I_i = 115 \text{ mA}$

or

$U_i = 32 \text{ V}$
 $I_i = 87.5 \text{ mA}$
 $P_i = 1 \text{ W}$
 $C_i = 5.3 \text{ nF}$
 L_i negligibly low

Position check-back type of protection Ex ia IIC/IIB/IIIC
(terminals 31/32) only for connection to a certified
intrinsically safe circuit

Maximum values:

$U_i = 28 \text{ V}$
 $I_i = 115 \text{ mA}$

or

$U_i = 32 \text{ V}$
 $I_i = 87.5 \text{ mA}$
 $P_i = 1 \text{ W}$
 $C_i = 5.3 \text{ nF}$
 L_i negligibly low

or

Binary input type of protection Ex ia IIC/IIB/IIIC
(terminals 31/32) only for connection to a certified
intrinsically safe circuit

Maximum values:

$U_i = 30 \text{ V}$
 $I_i = 100 \text{ mA}$
 $C_i = 56.3 \text{ nF}$
 L_i negligibly low

or

sheet 4/9

EU-Type Examination Certificates without signature and official stamp shall not be valid. The certificates may be circulated only without alteration. Extracts or alterations are subject to approval by the Physikalisch-Technische Bundesanstalt. In case of dispute, the German text shall prevail.

Physikalisch-Technische Bundesanstalt • Bundesallee 100 • 38116 Braunschweig • GERMANY

SCHEDULE TO EU-TYPE EXAMINATION CERTIFICATE PTB 10 ATEX 2007, Issue: 1

Structure-borne sound sensor (passive) type of protection Ex ia IIC/IIB/IIIC
(terminals 31/32) only for connection to a certified
intrinsically safe circuit

Maximum values:

$U_i = 30 \text{ V}$
 $I_i = 100 \text{ mA}$
 $C_o = 1.4 \text{ nF}$
 $C_i = 5.3 \text{ nF}$
 L_i negligibly low

Inductive limit contact type of protection Ex ia IIC/IIB/IIIC
(terminals 41/42) only for connection to a certified
intrinsically safe circuit

Maximum values:

$U_i = 16 \text{ V}$
 $I_i = 52 \text{ mA}$
 $P_i = 169 \text{ mW}$

or

$U_i = 16 \text{ V}$
 $I_i = 25 \text{ mA}$
 $P_i = 64 \text{ mW}$
 $C_i = 30 \text{ nF}$
 $L_i = 100 \text{ }\mu\text{H}$

For relationship between temperature class, permissible ranges of the ambient temperature, maximum short-circuit currents and maximum power for analyzing units connected to these clamps, reference is made to the table:

Temperature class	Permissible ambient temperature range	I_o / P_o
T6	... 45 °C	52 mA / 169 mW
T5	-55 °C ... 60 °C	
T4	... 75 °C	
T6	... 60 °C	25 mA / 64 mW
T5	-55 °C ... 80 °C	
T4	... 80 °C	

sheet 5/9

EU-Type Examination Certificates without signature and official stamp shall not be valid. The certificates may be circulated only without alteration. Extracts or alterations are subject to approval by the Physikalisch-Technische Bundesanstalt. In case of dispute, the German text shall prevail.

Physikalisch-Technische Bundesanstalt • Bundesallee 100 • 38116 Braunschweig • GERMANY



SCHEDULE TO EU-TYPE EXAMINATION CERTIFICATE PTB 10 ATEX 2007, Issue: 1

Software-limit contact type of protection Ex ia IIC/IIB/IIIC
(terminals 41/42 and 51/52) only for connection to a certified intrinsically safe circuit

Maximum values:

$U_i = 20 \text{ V}$
 $I_i = 60 \text{ mA}$
 $P_i = 250 \text{ mW}$
 $C_i = 5.3 \text{ nF}$
 L_i negligibly low

Magnet valve type of protection Ex ia IIC/IIB/IIIC
(terminals 81/82) only for connection to a certified intrinsically safe circuit

Maximum values:

$U_i = 28 \text{ V}$
 $I_i = 115 \text{ mA}$
or
 $U_i = 32 \text{ V}$
 $I_i = 87.5 \text{ mA}$
 $C_i = 5.3 \text{ nF}$
 L_i negligibly low

Fault signal output type of protection Ex ia IIC/IIB/IIIC
(terminals 83/84) only for connection to a certified intrinsically safe circuit

Maximum values:

$U_i = 20 \text{ V}$
 $I_i = 60 \text{ mA}$
 $P_i = 250 \text{ mW}$
 $C_i = 5.3 \text{ nF}$
 L_i negligibly low

Serial SSP interface type of protection Ex ia IIC/IIB/IIIC
(plug connector)

Maximum values (active):

$U_o = 7.88 \text{ V}$
 $I_o = 69.2 \text{ mA}$
 $P_o = 137 \text{ mW}$
linear characteristic

sheet 6/9

EU-Type Examination Certificates without signature and official stamp shall not be valid. The certificates may be circulated only without alteration. Extracts or alterations are subject to approval by the Physikalisch-Technische Bundesanstalt. In case of dispute, the German text shall prevail.

SCHEDULE TO EU-TYPE EXAMINATION CERTIFICATE PTB 10 ATEX 2007, Issue: 1

$C_o = 650 \text{ nF}$
 $L_o = 10 \text{ mH}$

or

only for connection to a certified
intrinsically safe circuit

Maximum values (passive):

$U_i = 20 \text{ V}$
 $I_i = 60 \text{ mA}$
 $P_i = 200 \text{ mW}$

C_i negligibly low
 L_i negligibly low

External position sensor type of protection Ex ia IIC/IIB/IIIC
(Analog PCB, pins p9, p10, p11)

Maximum values:

$U_o = 7.88 \text{ V}$
 $I_o = 13.2 \text{ mA}$
 $P_o = 27 \text{ mW}$

linear characteristic

$L_o = 10 \text{ mH}$
 $C_o = 1 \text{ }\mu\text{F}$
 $L_i = 370 \text{ }\mu\text{H}$
 $C_i = 66 \text{ nF}$

type 3730-6-510:

type of protection „tb“

Voltage/power supply Nominal signal: 4 ... 20 mA
(terminals 11/12) Rated voltage: 28V

Position check-back Nominal signal: 4 ... 20mA
(terminals 31/32) Rated voltage: 28V

Structure-borne sound sensor (passive) Capacity: max. 1,4 nF
(terminals 31/32) Rated voltage: 30V

Binary input Nominal signal: 0 ... 30 V DC
(terminals 31/32) Rated voltage: 30 V

Inductive limit contact Nominal signal: 8 V DC, 8 mA
(terminals 41/42) Rated voltage: 16 V

sheet 7/9

EU-Type Examination Certificates without signature and official stamp shall not be valid. The certificates may be circulated only without alteration. Extracts or alterations are subject to approval by the Physikalisch-Technische Bundesanstalt. In case of dispute, the German text shall prevail.

Physikalisch-Technische Bundesanstalt • Bundesallee 100 • 38116 Braunschweig • GERMANY



SCHEDULE TO EU-TYPE EXAMINATION CERTIFICATE PTB 10 ATEX 2007, Issue: 1

Software-limit contact (terminals 41/42; 51/52)	Nominal signal: 8 V DC, 8 mA Rated voltage: 20 V
Magnet valve (terminals 81/82)	Nominal signal: 6 ... 24 V DC Rated voltage: 28 V
Fault signal output (terminals 83/84)	Nominal signal: 6 ... 24 V DC Rated voltage: 28 V
Serial SSP interface (plug connector)	Nominal signal: SSP-interface Rated voltage: 20 V
External position sensor (flange coupling)	Nominal signal: 4 ... 20 mA Rated voltage: 28V

Changes with respect to previous editions

- Adaption to the state of the standards given above.
- Type 3730-6-510 is included in this edition. The changes only concern the marking for dust explosion protection.
- Incorporation of dust explosion protection through intrinsic safety.

(16) Test Report PTB Ex 19-25141

(17) Specific conditions of use

none

sheet 8/9

EU-Type Examination Certificates without signature and official stamp shall not be valid. The certificates may be circulated only without alteration. Extracts or alterations are subject to approval by the Physikalisch-Technische Bundesanstalt. In case of dispute, the German text shall prevail.

Physikalisch-Technische Bundesanstalt • Bundesallee 100 • 38116 Braunschweig • GERMANY



SCHEDULE TO EU-TYPE EXAMINATION CERTIFICATE PTB 10 ATEX 2007, Issue: 1

(18) Essential health and safety requirements

Met by compliance with the aforementioned standards.

According to Article 41 of Directive 2014/34/EU, EC-type examination certificates which have been issued according to Directive 94/9/EC prior to the date of coming into force of Directive 2014/34/EU (April 20, 2016) may be considered as if they were issued already in compliance with Directive 2014/34/EU. By permission of the European Commission supplements to such EC-type examination certificates and new issues of such certificates may continue to hold the original certificate number issued before April 20, 2016.

Konformitätsbewertungsstelle, Sektor Explosionsschutz
On behalf of PTB:

Braunschweig, January 20, 2020

Dr.-Ing. F. Lieneisch
Direktor und Professor



sheet 9/9

EU-Type Examination Certificates without signature and official stamp shall not be valid. The certificates may be circulated only without alteration. Extracts or alterations are subject to approval by the Physikalisch-Technische Bundesanstalt. In case of dispute, the German text shall prevail.

Physikalisch-Technische Bundesanstalt • Bundesallee 100 • 38116 Braunschweig • GERMANY



CONFORMITY STATEMENT

(Translation)

- (1)
- (2) Equipment and Protective Systems Intended for Use in Potentially Explosive Atmospheres - **Directive 94/9/EC**
- (3) Test Certificate Number:



PTB 10 ATEX 2008 X

- (4) Equipment: Digital positioner, type 3730-6-810
- (5) Manufacturer: SAMSON AG Mess- und Regeltechnik
- (6) Address: Weismüllerstr. 3, 60314 Frankfurt, Germany
- (7) This equipment and any acceptable variation thereto are specified in the schedule to this certificate and the documents therein referred to.
- (8) The Physikalisch-Technische Bundesanstalt, on the basis of the Council Directive 94/9/EC of 23 March 1994, certifies that this equipment has been found to comply with the Essential Health and Safety Requirements relating to the design and construction of equipment and protective systems intended for use in potentially explosive atmospheres, given in Annex II to the Directive.
- The examination and test results are recorded in the confidential assessment and test report PTB Ex 10-29352.
- (9) Compliance with the Essential Health and Safety Requirements has been assured by compliance with:
EN 60079-0:2006 EN 60079-15:2005 EN 61241-0:2006 EN 61241-1:2004
- (10) If the sign "X" is placed after the certificate number, it indicates that the equipment is subject to special conditions for safe use specified in the schedule to this certificate.
- (11) This Conformity Statement relates only to the design and construction of the specified equipment in accordance with Directive 94/9/EC. Further requirements of this Directive apply to the manufacture and supply of this equipment.
- (12) The marking of the equipment shall include the following:

II 3 G Ex nA II T6 or II 3 G Ex nL IIC/IIB T6 or II 3 D Ex tD A22 IP66 T80 °C

Zertifizierungssektor Explosionsschutz
On behalf of PTB:

Braunschweig, August 18, 2010

Dr.-Ing. U. Johannsmeyer
Direktor und Professor



Sheet 1/6

ZSEx10200e.dat

Conformity Statements without signature and official stamp shall not be valid. The certificates may be circulated only without alteration. Extracts or alterations are subject to approval by the Physikalisch-Technische Bundesanstalt. In case of dispute, the German text shall prevail.

Physikalisch-Technische Bundesanstalt • Bundesallee 100 • 38116 Braunschweig • GERMANY

SCHEDULE

(13)

(14)

CONFORMITY STATEMENT PTB 10 ATEX 2008 X

(15) Description of equipment

The digital positioner of type 3730-6-810 with HART communication is a single or double acting positioner. It is used for the conversion of electrical actuating signals into pneumatic actuating pressure signals.

The equipment is installed inside the hazardous area.

For relationship between type of protection, temperature class, options and permissible ambient temperature range, reference is made to the table:

Type of protection / Options	Permissible ambient temperature range
Ex nA IIC or Ex nL IIC	T6 60 °C
	T5 -55 °C ... 70 °C
	T4 80 °C
Option, structure-borne sound sensor	60 °C
	-40 °C ... 70 °C
	80 °C

Electrical data

Signal circuit type of protection Ex nA II
(terminals 11/12)

Maximum operational values:

I = 4 ... 20 mA

or

type of protection Ex nL IIC/IIB

U = 32 V

I = 132 mA

P = 1.2 W

L = negligibly low

C = 5.3 nF

Sheet 2/6

Conformity Statements without signature and official stamp shall not be valid. The certificates may be circulated only without alteration. Extracts or alterations are subject to approval by the Physikalisch-Technische Bundesanstalt. In case of dispute, the German text shall prevail.

Physikalisch-Technische Bundesanstalt • Bundesallee 100 • 38116 Braunschweig • GERMANY

Physikalisch-Technische Bundesanstalt



Braunschweig und Berlin

SCHEDULE TO EC-TYPE-EXAMINATION CERTIFICATE PTB 10 ATEX 2008 X

Position check-back.....type of protection Ex nA II
 or binary input
 or structure-borne sound sensor
 (terminals 31/32)

Maximum operational values:
 $I = 4 \dots 20 \text{ mA}$

or

type of protection Ex nL IIC/IIB

$U = 32 \text{ V}$
 $I = 132 \text{ mA}$

$L = \text{negligibly low}$
 $C = 56.3 \text{ nF}$

Inductive limit contacttype of protection Ex nA II
 (terminals 41/42)

Maximum operational values:

$U = 8 \text{ V}$
 $I = 8 \text{ mA}$

or

type of protection Ex nL IIC/IIB

$U = 20 \text{ V}$
 $I = 52 \text{ mA}$
 $P = 169 \text{ mW}$

or

$U = 20 \text{ V}$
 $I = 25 \text{ mA}$
 $P = 64 \text{ mW}$

$L = 100 \text{ }\mu\text{H}$
 $C = 30 \text{ nF}$

For relationship between temperature class, permissible ranges of the ambient temperature, maximum short-circuit currents and maximum power for analyzing units, reference is made to the table:

Temperature class	Permissible ambient temperature range	I_o / P_o
T6	... 45 °C	52 mA / 169 mW
T5	-55 °C ... 60 °C	
T4	... 75 °C	
T6	... 60 °C	25 mA / 64 mW
T5	-55 °C ... 80 °C	
T4	... 80 °C	

ZSEx10200e.dot

Sheet 3/6

Conformity Statements without signature and official stamp shall not be valid. The certificates may be circulated only without alteration. Extracts or alterations are subject to approval by the Physikalisch-Technische Bundesanstalt. In case of dispute, the German text shall prevail.

Physikalisch-Technische Bundesanstalt • Bundesallee 100 • 38116 Braunschweig • GERMANY

Physikalisch-Technische Bundesanstalt



Braunschweig und Berlin

SCHEDULE TO EC-TYPE-EXAMINATION CERTIFICATE PTB 10 ATEX 2008 X

Software-limit contacttype of protection Ex nA II
(terminals 41/42 and 51/52)

Maximum operational values:

U = 8 V
I = 8 mA

or

type of protection Ex nL IIC/IIB

U = 20 V
I = 60 mA
P = 400 mW

L = negligibly low
C = 5.3 nF

Magnet valvetype of protection Ex nA II
(terminals 81/82)

Maximum operational values:

U = 6 ... 24 V DC

or

type of protection Ex nL IIC/IIB

U = 32 V
I = 132 mA

L = negligibly low
C = 5.3 nF

Fault signal outputtype of protection Ex nA II
(terminals 83/84)

Maximum operational values:

U = 8 V
I = 8 mA

or

type of protection Ex nL IIC/IIB

U = 20 V
I = 60 mA
P = 400 mW

L = negligibly low
C = 5.3 nF

ZSEx10200e.ddt

Sheet 4/6

Conformity Statements without signature and official stamp shall not be valid. The certificates may be circulated only without alteration. Extracts or alterations are subject to approval by the Physikalisch-Technische Bundesanstalt. In case of dispute, the German text shall prevail.

Physikalisch-Technische Bundesanstalt • Bundesallee 100 • 38116 Braunschweig • GERMANY

Serial SSP interface..... type of protection Ex nA II
(plug connector)

Maximum operational values:

U = 8 V DC
I = 20 mA

or

type of protection Ex nL IIC/IIB

U = 20 V
I = 60 mA
P = 200 mW

L = negligibly low
C = 5.3 nF

External position sensor..... type of protection Ex nA II
(Analog PCB, pins p9, p10, p11) or Ex nL IIC/IIB

Maximum operational values:

U = 7.88 V
I = 61 mA
P = 120 mW

L = 10 mH
C = 1 μ F

(16) Assessment and test report PTB Ex 10-29352

(17) Special conditions for safe use

Type of protection Ex nA II:

A fuse according to IEC 60127-2/II, 250 V F or IEC 60127-2/VI, 250 V T with a nominal fuse current of max. 80 mA shall be connected in series to the signal circuit and to the position check-back circuit.

A fuse according to IEC 60127-2/II, 250 V F or IEC 60127-2/VI, 250 V T with a nominal fuse current of max. 40 mA shall be connected in series to the serial SSP interface.

All fuses shall be installed outside of the hazardous area.

Type of protection Ex nL IIC:

No fuses are required for the operation with energy-limited circuits of type of protection Ex nL IIC.

ZSEx10200e.dot

Sheet 5/6

Conformity Statements without signature and official stamp shall not be valid. The certificates may be circulated only without alteration. Extracts or alterations are subject to approval by the Physikalisch-Technische Bundesanstalt. In case of dispute, the German text shall prevail.

Physikalisch-Technische Bundesanstalt • Bundesallee 100 • 38116 Braunschweig • GERMANY

Physikalisch-Technische Bundesanstalt



Braunschweig und Berlin

SCHEDULE TO EC-TYPE-EXAMINATION CERTIFICATE PTB 10 ATEX 2008 X

(18) Essential health and safety requirements

met by compliance with the standards mentioned above

Zertifizierungssektor Explosionsschutz
On behalf of PTB:

Braunschweig, August 18, 2010

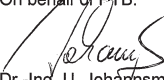
Dr.-Ing. U. Johannsmeyer
Direktor und Professor



ZSE:10200e-ddt

Sheet 6/6

Conformity Statements without signature and official stamp shall not be valid. The certificates may be circulated only without alteration. Extracts or alterations are subject to approval by the Physikalisch-Technische Bundesanstalt. In case of dispute, the German text shall prevail.

Physikalisch-Technische Bundesanstalt • Bundesallee 100 • 38116 Braunschweig • GERMANY

1. E R G Ä N Z U N G

zur Konformitätsaussage PTB 10 ATEX 2008 X

Gerät: Digitaler Stellungsregler Typ 3730-6-810..

Kennzeichnung:  II 3 G Ex nA II T6 bzw. II 3 G Ex nL IIC/IIB T6 bzw. II 3 D Ex tD A22 IP66 T80 °C

Hersteller: SAMSON AG Mess- und Regeltechnik

Anschrift: Weismüllerstr. 3, 60314 Frankfurt, Deutschland

Beschreibung der Ergänzungen und Änderungen

Der Digitale Stellungsregler Typ 3760-6-810.. mit HART Kommunikation ist ein einfach bzw. doppelt wirkender Stellungsregler. Er dient der Umwandlung von elektrischen Stellsignalen in pneumatische Stelldrucksignale.

Der Einsatz erfolgt innerhalb des explosionsgefährdeten Bereiches.

Der Zusammenhang zwischen der Zündschutzart, der Temperaturklasse, den Optionen und dem zulässigen Umgebungstemperaturbereich ist der Tabelle zu entnehmen.

Zündschutzart / Optionen	Zulässiger Umgebungstemperaturbereich
Ex ic IIC bzw. Ex nA II	T6 60 °C
	T5 -55 °C ... 70 °C
	T4 80 °C
Option Körperschallsensor	60 °C
	-40 °C ... 70 °C
	80 °C

Elektrische Daten

Signalstromkreisin Zündschutzart Eigensicherheit Ex ic IIC
(Klemmen 11/12) nur zum Anschluss an einen bescheinigten
eigensicheren Stromkreis

Höchstwerte:

$U_i = 32 \text{ V}$
 $I_i = 132 \text{ mA}$
 $P_i = 1,2 \text{ W}$

ZSEx10201d.docx

Seite 1/5

Konformitätsaussagen ohne Unterschrift und ohne Siegel haben keine Gültigkeit.
Diese Konformitätsaussage darf nur unverändert weiterverbreitet werden.
Auszüge oder Änderungen bedürfen der Genehmigung der Physikalisch-Technischen Bundesanstalt.
Physikalisch-Technische Bundesanstalt • Bundesallee 100 • 38116 Braunschweig • DEUTSCHLAND

L_i vernachlässigbar klein

$C_i = 5,3 \text{ nF}$

bzw.

in Zündschutzart Ex nA II

Stellungsrückmelderin Zündschutzart Eigensicherheit Ex ic IIC
bzw. Binäreingang
bzw. Körperschallsensor
(Klemmen 31/32) nur zum Anschluss an einen bescheinigten
eigensicheren Stromkreis

Höchstwerte:

$U_i = 32 \text{ V}$

$I_i = 132 \text{ mA}$

$P_i = 1 \text{ W}$ (nur für den
Stellungsrückmelder zutreffend)

L_i vernachlässigbar klein

$C_i = 56,3 \text{ nF}$

bzw.

in Zündschutzart Ex nA II

Induktiver Grenzkontaktin Zündschutzart Eigensicherheit Ex ic IIC
(Klemmen 41/42) nur zum Anschluss an einen bescheinigten
eigensicheren Stromkreis

Höchstwerte:

$U_i = 20 \text{ V}$

$I_i = 52 \text{ mA}$

$P_i = 169 \text{ mW}$

bzw.

$U_i = 20 \text{ V}$

$I_i = 25 \text{ mA}$

$P_i = 64 \text{ mW}$

$L_i = 100 \text{ } \mu\text{H}$

$C_i = 30 \text{ nF}$

bzw.

in Zündschutzart Ex nA II

Der Zusammenhang zwischen der Temperaturklasse, den zulässigen Umgebungstemperaturbereichen, den maximalen Kurzschlussströmen und der maximalen Leistung für Auswertegeräte ist der Tabelle zu entnehmen:

Temperaturklasse	Zulässiger Umgebungstemperaturbereich	I / P
T6	... 45 °C	52 mA / 169 mW
T5	-55 °C ... 60 °C	
T4	... 75 °C	
T6	... 60 °C	25 mA / 64 mW
T5	-55 °C ... 80 °C	
T4	... 80 °C	

Software-Grenzkontaktein Zündschutzart Eigensicherheit Ex ic IIC
(Klemmen 41/42 und 51/52) nur zum Anschluss an einen bescheinigten eigensicheren Stromkreis

Höchstwerte:

$$U_i = 20 \text{ V}$$

$$I_i = 60 \text{ mA}$$

$$P_i = 400 \text{ mW}$$

L_i vernachlässigbar klein

$$C_i = 5,3 \text{ nF}$$

bzw.

in Zündschutzart nA II

Magnetventilin Zündschutzart Eigensicherheit Ex ic IIC
(Klemmen 81/82) nur zum Anschluss an einen bescheinigten eigensicheren Stromkreis

Höchstwerte:

$$U_i = 32 \text{ V}$$

$$I_i = 132 \text{ mA}$$

L_i vernachlässigbar klein

$$C_i = 5,3 \text{ nF}$$

bzw.

in Zündschutzart Ex nA II

Störmeldeausgang.....in Zündschutzart Eigensicherheit Ex ic IIC
(Klemmen 83/84) nur zum Anschluss an einen bescheinigten
eigensicheren Stromkreis

Höchstwerte:

$$U_i = 20 \text{ V}$$

$$I_i = 60 \text{ mA}$$

$$P_i = 400 \text{ mW}$$

$$L_i \text{ vernachlässigbar klein}$$

$$C_i = 5,3 \text{ nF}$$

bzw.

in Zündschutzart Ex nA II

Serielle Schnittstelle SSPin Zündschutzart Eigensicherheit Ex ic IIC
(Steckverbinder) nur zum Anschluss an einen bescheinigten
eigensicheren Stromkreis

Höchstwerte:

$$U_i = 20 \text{ V}$$

$$I_i = 60 \text{ mA}$$

$$P_i = 200 \text{ mW}$$

$$L_i \text{ vernachlässigbar klein}$$

$$C_i = 5,3 \text{ nF}$$

bzw.

in Zündschutzart Ex nA II

Externer Positionssensorin Zündschutzart Eigensicherheit Ex ic IIC
(Analogplatine Pins p9, p10, p11) nur zum Anschluss an einen bescheinigten
eigensicheren Stromkreis

Höchstwerte:

$$U_i = 7,88 \text{ V}$$

$$I_i = 61 \text{ mA}$$

$$P_i = 120 \text{ mW}$$

$$L_i = 10 \text{ mH}$$

$$C_i = 1 \text{ }\mu\text{F}$$

bzw.

in Zündschutzart Ex nA II

Die besonderen Bedingungen der Konformitätsaussage werden modifiziert:

Zündschutzart Ex ic IIC:

keine besonderen Anforderungen

Zündschutzart Ex nA II:

Dem Signalstromkreis und dem Stellungsrückmelderstromkreis ist jeweils eine Sicherung nach IEC 60127-2/II, 250 V F bzw. nach IEC 60127-2/VI, 250 V T mit einem Sicherungsnennstrom von maximal 80 mA vorzuschalten.

Bei der Seriellen Schnittstelle SSP ist in die Verbindung Vcc eine Sicherung nach IEC 60127-2/II, 250 V F bzw. nach IEC 60127-2/VI, 250 V T mit einem Sicherungsnennstrom von maximal 40 mA vorzuschalten.

Alle Sicherungen sind außerhalb des explosionsgefährdeten Bereiches zu errichten.

Künftige Kennzeichnung:

 II 3 G Ex ic nA IIC T6 Gc bzw. II 3 D Ex tc IIIC T80 °C Dc IP66

Angewandte Normen

EN 60079-0:2009 EN 60079-11:2012 EN 60079-15:2010 EN 60079-31:2009

Prüfbericht: PTB Ex 14-24013

Konformitätsbewertungsstelle, Sektor Explosionsschutz

Braunschweig, 27. August 2014

Im Auftrag

Dr.-Ing. T. Horn
Regierungsrat





IECEX Certificate of Conformity

INTERNATIONAL ELECTROTECHNICAL COMMISSION IEC Certification System for Explosive Atmospheres

for rules and details of the IECEX Scheme visit www.iecex.com

Certificate No.: **IECEX PTB 10.0057** Page 1 of 4 Certificate history:
Issue 0 (2010-12-10)

Status: **Current** Issue No: 1

Date of Issue: 2020-09-17

Applicant: **SAMSON AKTIENGESELLSCHAFT**
Weismüllerstraße 3
60314 Frankfurt am Main
Germany

Equipment: **Digital positioner, type 3730-6-111, 3730-6-211 and 3730-6-511 with HART communication**

Optional accessory:

Type of Protection: **Intrinsic Safety "I", Flameproof enclosures „d“, Protection by enclosures „tD“**

Marking: type 3730-6-111
Ex ia IIIC T80 °C Db and Ex ia IIC T6 Gb

type 3730-6-211
Ex db[ia] IIC T6 Gb and Ex tb IIIC T80 °C Db

type 3730-6-511
Ex tb IIIC T80 °C Db

Approved for issue on behalf of the IECEX
Certification Body:

Dr. F. Lienesch

Position:

**Head of Department "Explosion Protection in Sensor
Technology and Instrumentation"**

Signature:
(for printed version)

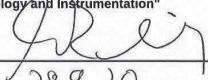
28.9.20

Date:

1. This certificate and schedule may only be reproduced in full.
2. This certificate is not transferable and remains the property of the issuing body.
3. The Status and authenticity of this certificate may be verified by visiting www.iecex.com or use of this QR Code.



Certificate issued by:

Physikalisch-Technische Bundesanstalt (PTB)
Bundesallee 100
38116 Braunschweig
Germany





IECEx Certificate of Conformity

Certificate No.: **IECEx PTB 10.0057**

Page 2 of 4

Date of issue: 2020-09-17

Issue No: 1

Manufacturer: **SAMSON AG Mess- und Regeltechnik**
Weismuellerstr. 3
60314 Frankfurt am Main
Germany

Additional
manufacturing
locations:

This certificate is issued as verification that a sample(s), representative of production, was assessed and tested and found to comply with the IEC Standard list below and that the manufacturer's quality system, relating to the Ex products covered by this certificate, was assessed and found to comply with the IECEx Quality system requirements. This certificate is granted subject to the conditions as set out in IECEx Scheme Rules, IECEx 02 and Operational Documents as amended

STANDARDS :

The equipment and any acceptable variations to it specified in the schedule of this certificate and the identified documents, was found to comply with the following standards

IEC 60079-0:2017 Explosive atmospheres - Part 0: Equipment - General requirements
Edition:7.0

IEC 60079-11:2011 Explosive atmospheres - Part 11: Equipment protection by intrinsic safety "i"
Edition:6.0

IEC 60079-31:2013 Explosive atmospheres - Part 31: Equipment dust ignition protection by enclosure "t"
Edition:2

This Certificate **does not** indicate compliance with safety and performance requirements other than those expressly included in the Standards listed above.

TEST & ASSESSMENT REPORTS:

A sample(s) of the equipment listed has successfully met the examination and test requirements as recorded in:

Test Report:

DE/PTB/EXTR10.0065/01

Quality Assessment Report:

DE/TUN/QAR06.0011/10



IECEx Certificate of Conformity

Certificate No.: **IECEx PTB 10.0057**

Page 3 of 4

Date of issue: 2020-09-17

Issue No: 1

EQUIPMENT:

Equipment and systems covered by this Certificate are as follows:

The digital positioner with HART communication is a single or double acting positioner. It is used for the conversion of electrical actuating signals into pneumatic actuating pressure signals.

The equipment is installed inside the hazardous area.

The equipment is available in two designs, type 3730-6-111 and type 3730-6-211 with a field barrier connected in series.

For further information see schedule.

SPECIFIC CONDITIONS OF USE: NO



IECEx Certificate of Conformity

Certificate No.: IECEx PTB 10.0057

Page 4 of 4

Date of issue: 2020-09-17

Issue No: 1

DETAILS OF CERTIFICATE CHANGES (for issues 1 and above)

1. Adding the modifications of the first and second supplement of PTB 10 ATEX 2007.
2. Update to Standards IEC 60079-0:2017, IEC 60079-11:2012 and IEC 60079-31:2014.
3. Added positioner connection to intrinsically safe circuits of Group III.
4. Added to the model code 3790-6-511 for type of protection Ex tb.
5. Added a dedicated nameplate for the Ex tb unit.
6. Update labelling according to the following table for housings with closed cover or with window in the cover according to drawings 1050-1443, 1050-1444
7. Labelling

Annex:

Annex to IECEx PTB 10.0057 issue-01.pdf



IECEx Certificate of Conformity

INTERNATIONAL ELECTROTECHNICAL COMMISSION IEC Certification Scheme for Explosive Atmospheres

for rules and details of the IECEx Scheme visit www.iecex.com

Certificate No.: issue No.: Certificate history:

Status:

Date of Issue: Page 1 of 3

Applicant: **SAMSON AG Mess- und Regeltechnik**
Weismuellerstr. 3
60314 Frankfurt am Main
Germany

Electrical Apparatus: **Digital positioner, type 3730-6-811**
Optional accessory:

Type of Protection: **Construction, test and marking of type of protection "n", Protection by enclosures „tD“**

Marking: **Ex nA II T6 or Ex nL IIC/IB T6 or Ex tD A22 IP66 T80 °C**

Approved for issue on behalf of the IECEx Certification Body: **Dr.-Ing. U. Johannsmeyer**

Position: **Department Head "Intrinsic Safety and Safety of Systems"**

Signature:
(for printed version)

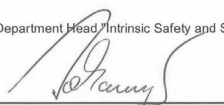

2011-01-12

Date:

1. This certificate and schedule may only be reproduced in full.
2. This certificate is not transferable and remains the property of the issuing body.
3. The Status and authenticity of this certificate may be verified by visiting the Official IECEx Website.

Certificate issued by:

Physikalisch-Technische Bundesanstalt (PTB)
Bundesallee 100
38116 Braunschweig
Germany





IECEX Certificate of Conformity

Certificate No.: IECEX PTB 10.0058X
Date of Issue: 2010-12-10 Issue No.: 0
Page 2 of 3

Manufacturer: **SAMSON AG Mess- und Regeltechnik**
Weismuellerstr. 3
60314 Frankfurt am Main
Germany

Manufacturing location(s):

This certificate is issued as verification that a sample(s), representative of production, was assessed and tested and found to comply with the IEC Standard list below and that the manufacturer's quality system, relating to the Ex products covered by this certificate, was assessed and found to comply with the IECEX Quality system requirements. This certificate is granted subject to the conditions as set out in IECEX Scheme Rules, IECEX 02 and Operational Documents as amended.

STANDARDS:

The electrical apparatus and any acceptable variations to it specified in the schedule of this certificate and the identified documents, was found to comply with the following standards:

IEC 60079-0 : 2004 Edition: 4.0	Electrical apparatus for explosive gas atmospheres - Part 0: General requirements
IEC 60079-15 : 2001 Edition: 2	Electrical apparatus for explosive gas atmospheres - Part 15: Type of protection 'n'
IEC 61241-0 : 2004 Edition: 1	Electrical apparatus for use in the presence of combustible dust - Part 0: General requirements
IEC 61241-1 : 2004 Edition: 1	Electrical apparatus for use in the presence of combustible dust - Part 1: Protection by enclosures "ID"

This Certificate does not indicate compliance with electrical safety and performance requirements other than those expressly included in the Standards listed above.

TEST & ASSESSMENT REPORTS:

A sample(s) of the equipment listed has successfully met the examination and test requirements as recorded in

Test Report:

DE/PTB/EXTR10.0066/00

Quality Assessment Report:

DE/TUN/QAR06.0011/03



IECEx Certificate of Conformity

Certificate No.: IECEx PTB 10.0058X

Date of Issue: 2010-12-10

Issue No.: 0

Page 3 of 3

Schedule

EQUIPMENT:

Equipment and systems covered by this certificate are as follows:

The digital positioner of type 3730-6-811 with HART communication is a single or double acting positioner. It is used for the conversion of electrical actuating signals into pneumatic actuating pressure signals.

The equipment is installed inside the hazardous area.

For relationship between type of protection, temperature class, options and permissible ambient temperature range, reference is made to the table:

For further information see schedule

CONDITIONS OF CERTIFICATION: YES as shown below:

Type of protection Ex nA II: A fuse according to IEC 60127-2/II, 250 V F or IEC 60127-2/VI, 250 V T with a nominal fuse current of max. 80 mA shall be connected in series to the signal circuit and to the position check-back circuit. A fuse according to IEC 60127-2/II, 250 V F or IEC 60127-2/VI, 250 V T with a nominal fuse current of max. 40 mA shall be connected in series to the serial SSP interface. All fuses shall be installed outside of the hazardous area.

Type of protection Ex nL IIC: No fuses are required for the operation with energy-limited circuits of type of protection Ex nL IIC.

Installation Manual for apparatus certified by CSA / FM for use in hazardous locations.
 Intrinsically safe if installed as specified in manufacturer's installation manual.

CSA- certified for hazardous locations

Ex ia IIC T6: Class I, Zone 0
 Class I, Div. 1, Groups A, B, C, D.
 Class II Div. 1, Groups E, F + G; Class III.
 Type 4 Enclosure

FM- approved for hazardous locations

AEx ia IIC T6: Class I, Zone 0
 Class I, Div. 1, Groups A, B, C, D.
 Class II, Div. 1, Groups E, F + G, Class III
 Field enclosures NEMA 4X

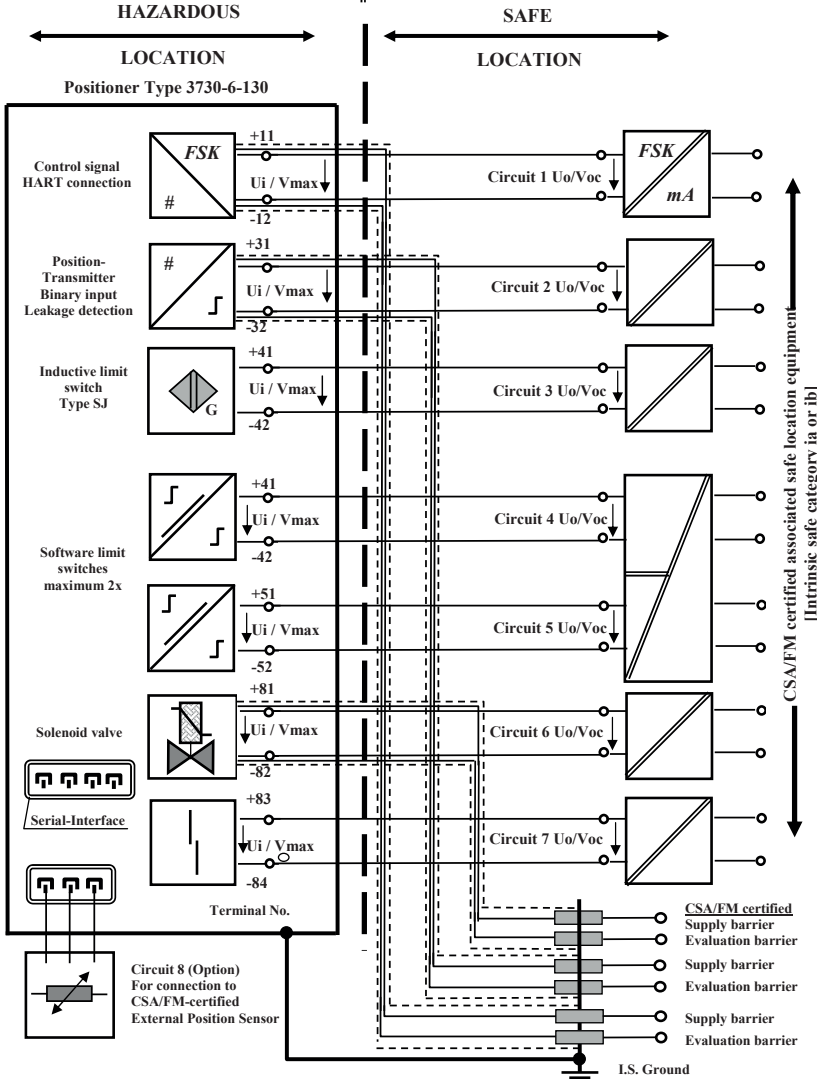

Notes general for CSA Certification:

- 1.) The apparatus may be installed in intrinsically safe circuits only when used in conjunction with CSA / FM certified apparatus. For maximum values of U_i or V_{max} ; I_i or I_{max} ; P_i or P_{max} ; C_i and L_i of the various apparatus see Table 1, 2 and 3 on page 1 and 3
- 2.) For barrier selection see Table 2 on page 3.
- 3.) Use only supply wires suitable for 5°C above surrounding temperature.
- 4.) For the permissible maximum values for the intrinsically safe circuits 1, 3, 4 and 6 see Table 1 and 2
For the permissible barrier parameters for the circuits 1, 2 and 6 see Table 2
- 5.) Cable entry M 20 x 1.5 or metal conduit according to drawing No. 1050 – 0540 T

Notes for CSA Installation:

The installation must be in accordance with the C. E. C. Part 1. (Canadian Electrical Code)
For CSA installation, Safety Barrier must be CSA Certified and installed in accordance with C.E.C. Part. 1
Each pair of I.S. wires must be protected by a shield that is grounded at the I.S. Ground. The shield must extend as close to the terminals as possible install per C.E. Part 1.
Division 2 wiring method shall be in accordance to the Canadian Electrical Code Part 1.

Notes for FM Installation:

The installation must be in accordance with the National Electrical Code ANSI/NFPA 70 and ANSI/RP 12.06.01
For FM installation, Safety Barrier must be FM approved and installed in accordance with ANSI/NFPA 70 and ANSI/RP 12.06.01
Each pair of I.S. wires must be protected by a shield that is grounded at the I.S. Ground. The shield must extend as close to the terminals as possible install per National Electrical Code ANSI/NFPA 70 and ANSI/RP 12.06.01
Division 2 wiring method shall be in accordance to the ANSI/NFPA 70 and ANSI/RP 12.06.01

Electrical rating of intrinsically safe apparatus and apparatus for installation in hazardous locations.

Table 1: Maximum values

Circuit No.	HART-connection		Position transmitter		Binar-Input	Leakage sensor	Limit switches		Solenoid valve	Fault alarm output
	1	2	3	4 and 5	6	7				
Terminal No.	11 / 12		31 / 32			41 / 42	41 / 42 51 / 52	81 / 82	83 / 84	
U_i or V_{max} [V]	28	32	28	32	30	###	16	20	28/32	20
I_i or I_{max} [mA]	115	87.5	115	87.5	100	###	25/52	60	115/87.5	60
P_i or P_{max} [W]	1		1		###	###	64/169	250	1	250
C_i	5.3nF		5.3nF		56.3nF	5.6nF	30nF	5.3nF	5.3nF	5.3nF
L_i	0μH		0μH		0μH	0 1.4nF	100μH	0μH	0μH	0μH

Circuit	Serial interface BU			External position sensor ($R_i \geq 10K\Omega$ passive)		
Terminal	Connector			Analog pcb. pin p9, p10, p11/ External Connector		
U_i or V_{max} [V]	20V	U_0 or V_{0C}	7.88V	U_0 or V_{0C}	7.88V	
I_i or I_{max} [mA]	60 mA	I_0 or I_{SC}	69.2 mA	I_0 or I_{SC}	13.2 mA	
P_i or P_{max} [W]	200 mW	P_0 or P_{max}	137 mW	P_0 or P_{max}	27 mW	
C_i	0nF	C_0	1.65 μ F	C_0	1.65 μ F	$C_i=66$ nF
L_i	0 μ H	L_0	10 mH	L_0	10 mH	$L_i=370$ μ H

Table 2: CSA/FM – certified barrier parameters of circuit 1, 2 and 6

Barrier	Supply barrier				Evaluation barrier		
	V_{0C}	R_{min}	I_{SC}	P_{max}	V_{0C}	R_{min}	I_{SC}
circuit 1,2,6	$\leq 28V$	$\geq 245\Omega$	$\leq 115mA$	$\leq 1W$	$\leq 28V$	#	0mA

Barrier	Output System Parameters		Output Entity Parameters		
	V_{max}	R_{min}	V_{max}	I_{SC}	P_O
circuit 1,2,6	$\leq 28V$	$\geq 245\Omega$	$\leq 28V$	115mA	1W

In grounded signal circuits with only one barrier, the return line must be grounded or included in the potential equalization network of the system

Notes: Entity parameters must meet the following requirements:

$$U_0 \text{ or } V_{0C} \leq U_i \text{ or } V_{max} / I_0 \text{ or } I_{SC} \leq I_i \text{ or } I_{max} / P_0 \text{ or } P_{max} \leq P_i \text{ or } P_{max}$$

$$C_a \geq C_i + C_{cable} \text{ and } L_a \geq L_i + L_{cable}$$

Table 3: For the Model 3730 – 6-130 Positioners the correlation between temperature classification, permissible ambient temperature ranges and maximum short-circuit current is shown in the table below:

Permissible ambient temperature range				
		HART positioner	Limit switch inductive	
			$I_0=25mA/P_0=64mW$	$I_0=52mA/P_0=169mW$
Temperaturklasse	T6	$-55^\circ C \leq T_a \leq +60^\circ C$	$\leq +60^\circ C$	$\leq +45^\circ C$
	T5	$-55^\circ C \leq T_a \leq +70^\circ C$	$\leq +70^\circ C$	$\leq +60^\circ C$
	T4	$-55^\circ C \leq T_a \leq +80^\circ C$	$\leq +80^\circ C$	$\leq +70^\circ C$

CSA- certified for hazardous locations

Ex nA II T6 / Ex nL HC T6 Class I, Zone 2
 Class I, Div. 2, Groups A, B, C, D,
 Class II, Div. 2 Groups E, F +G; Class III
 (Non- incindive Field wiring)

Type 4 Enclosure

FM- approved for hazardous locations

AEx nA II T6; Ex nL HC T6 Class I, Zone 2.
 Class I, Div. 2 Groups A, B, C, D
 Class II, Div. 2 Groups E, F +G; Class III
 (Non- incindive Field wiring)

Field enclosures NEMA 4X

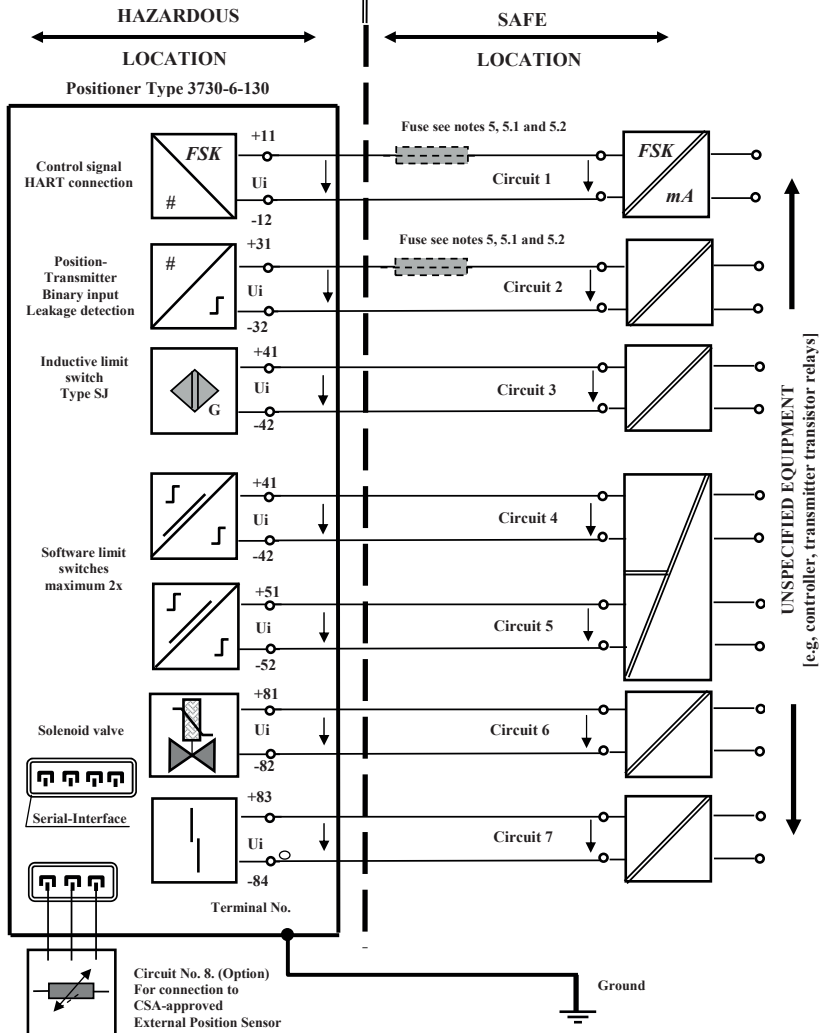

Note:

- 1.) The installation must be in accordance with the Canadian Electrical Code, Part 1
- 2.) For the maximum values for the individual energy limited circuits see Table 4.
- 3.) Cable entry only rigid metal conduit according to drawing No. 1050-0539 T and 1050-0540 T
- 4.) The positioners rated voltage is 32 V DC and thus below the limit of 75 V DC specified in IEC 60079-15:2001, Clause 12 b.
- 5.) For type of protection Ex nA, the signal current circuit and the position transmitter circuit is to be connected in series with a fuse according to IEC 60127-2/II, 250 V F or according to IEC 60127-2/VI, 250 V T with a rated fuse current of max. $I_n \leq 80\text{mA}$.
- 5.1) For type of protection Ex nA, the Vcc connection in the program interface adapter is to be connected in series with a fuse according to IEC 60127-2/II, 250 V F or according to IEC 60127-2/VI, 250 V T with a rated fuse current of max. $I_n \leq 40\text{mA}$.
- 5.2) The fuses must be installed **outside the hazardous area**.

No fuses are required for connection to current circuits with limited energy in type of protection Ex nL.

Table 4: Electrical rating of energy-limited circuits (Non- Incendive) Parameters

Circuit No.	HART-connection	Position transmitter	Binar-Input	Structure-borne sound sensor	Limit switches		Solenoid valve	Fault alarm output
	1	2			3	4 and 5		
Terminal No.	11 / 12	31 / 32			41 / 42	41 / 42 51 / 52	81 / 82	83 / 84
U_i or V_{max} [V]	32	32	32	###	20	20	32	20
I_i or I_{max} [mA]	132	132	132	###	25/52	60	132	60
P_i or P_{max} [W]	1.2	1.2	###	###	64/169	400	###	400
C_i	5.3nF	5.3nF	56.3nF	5.3nF	30nF	5.3nF	5.3nF	5.3nF
L_i	0 μ H	0 μ H	0 μ H	C0 1.4nF	100 μ H	0 μ H	0 μ H	0 μ H
Circuit	Serial interface BU			External position sensor ($R_i \geq 10\text{K}\Omega$ passive)				
Terminal	Connector			Analog pcb. pin p9, p10, p11/ External Connector				
U_i or V_{max} [V]	20V	U_0 or V_{0C}	7.88V	U_0 or V_{0C}	7.88V			
I_i or I_{max} [mA]	60 mA	I_0 or I_{SC}	69.2 mA	I_0 or I_{SC}	13.2 mA			
P_i or P_{max} [W]	400 mW	P_0 or P_{max}	137 mW	P_0 or P_{max}	27 mW			
C_i	0 nF	C_0	10 μ F	C_0	10 μ F	$C_i=66$ nF		
L_i	0 μ H	L_0	10 mH	L_0	10 mH	$L_i=370$ μ H		

Installation manual for equipment certified by FM for use in hazardous areas
 Intrinsically safe if installed as specified in manufacturer's installation manual

FM approved for hazardous areas

Class I, II, III, Div. 1, Groups A, B, C, D, E, F, G
Class I, Zone 0, AEx ia IIC

Field enclosures NEMA 4X

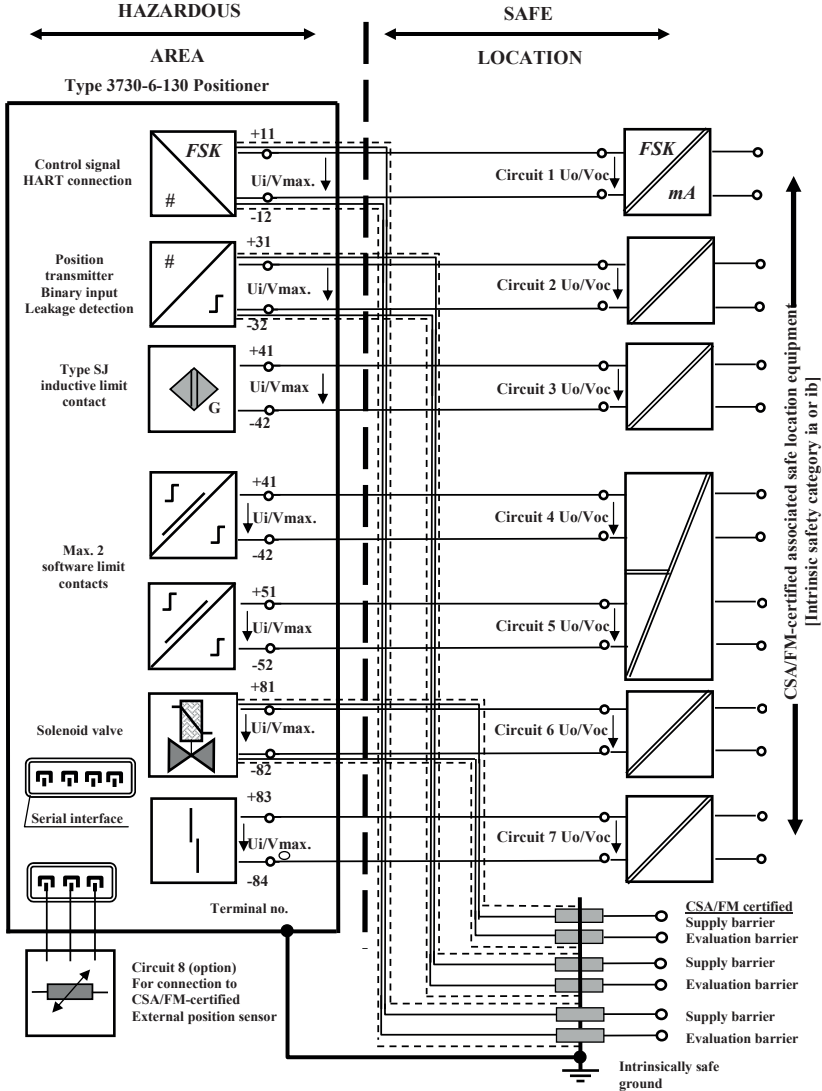

Notes on FM installation:

Installation must be in accordance with ANSI/NFPA 70 and ANSI/RP 12.06.01.

For FM installation, safety barriers must be FM approved and installed in accordance with ANSI/NFPA 70 and ANSI/RP 12.06.01.

Each pair of intrinsically safe wires must be protected by a shield that is grounded at the intrinsically safe ground. The shield must extend as close to the terminals as possible (installation acc. To ANSI/NFPA 70 and ANSI/RP 12.06.01).

The division 2 wiring method must be in accordance with ANSI/NFPA 70 and ANSI/RP 12.06.01.

Electrical rating of intrinsically safe equipment and equipment for installation in hazardous areas

Table 1: Maximum values

Circuit no.	HART connection		Position transmitter		Binary input	Leakage sensor	Limit contacts		Solenoid valve	Fault alarm output
	1	2	3	4 and 5	6	7				
Terminal no.	11/12		31/32				41/42	41/42 51/52	81/82	83/84
U_i or V_{max} [V]	28	32	28	32	30	###	16	20	28/32	20
I_i or I_{max} [mA]	115	87.5	115	87.5	100	###	25/52	60	115/87.5	60
P_i or P_{max} [W]	1		1		###	###	64/169	250	1	250
C_i	5.3 nF		5.3 nF		56.3 nF	5.6 nF	30 nF	5.3 nF	5.3 nF	5.3 nF
L_i	0 μ H		0 μ H		0 μ H	C0 1.4 nF	100 μ H	0 μ H	0 μ H	0 μ H

Circuit	Serial interface BU			External position sensor ($R_i \geq 10 \text{ K}\Omega$ passive)		
Terminal	Connector			Analog PCB pin p9, p10, p11/external connector		
U_i or V_{max} [V]	20 V	U_0 or V_{0C}	7.88 V	U_0 or V_{0C}	7.88 V	
I_i or I_{max} [mA]	60 mA	I_0 or I_{SC}	69.2 mA	I_0 or I_{SC}	13.2 mA	
P_i or P_{max} [W]	200 mW	P_0 or P_{max}	137 mW	P_0 or P_{max}	27 mW	
C_i	0 nF	C_0	650 nF	C_0	1.0 μ F	$C_i=66 \text{ nF}$
L_i	0 μ H	L_0	10 mH	L_0	10 mH	$L_i=370 \mu\text{H}$

Table 2: CSA/FM-certified barrier parameters of circuit 1, 2 and 6

Barrier	Supply barrier				Evaluation barrier		
	V _{0C}	R _{min.}	I _{SC}	P _{max.}	V _{0C}	R _{min.}	I _{SC}
Circuit 1 ,2, 6	≤ 28 V	≥ 245 Ω	≤ 115 mA	≤ 1 W	≤ 28 V	#	0 mA

In grounded signal circuits with only one barrier, the return line must be grounded or included in the equipotential bonding system of the system.

Note! Entity parameters must meet the following requirements:

U_0 or $V_{0C} \leq U_i$ or $V_{max.}/I_0$ or $I_{SC} \leq I_i$ or $I_{max.}/P_0$ or $P_{max.} \leq P_i$ or $P_{max.}$

$C_a \geq C_i + C_{cable}$ and $L_a \geq L_i + L_{cable}$

Table 3: Relation between temperature class, permissible ambient temperature and max. short-circuit current for Type 3730-6-130

Permissible ambient temperature range				
		HART positioner	Inductive limit contact	
			I ₀ =25 mA/P ₀ =64 mW	I ₀ =52 mA/P ₀ =169 mW
Temperature class	T6	-55 ≤ T _a ≤ +60 °C	≤ +60 °C	≤ +45 °C
	T5	-55 ≤ T _a ≤ +70 °C	≤ +70 °C	≤ +60 °C
	T4	-55 ≤ T _a ≤ +80 °C	≤ +80 °C	≤ +70 °C

FM approved for hazardous areas

Class I, Div. 2 Groups A, B, C, D
Class II, III, Div. 2 Groups E, F, G
 (non-incendive field wiring)

Field enclosures NEMA 4X

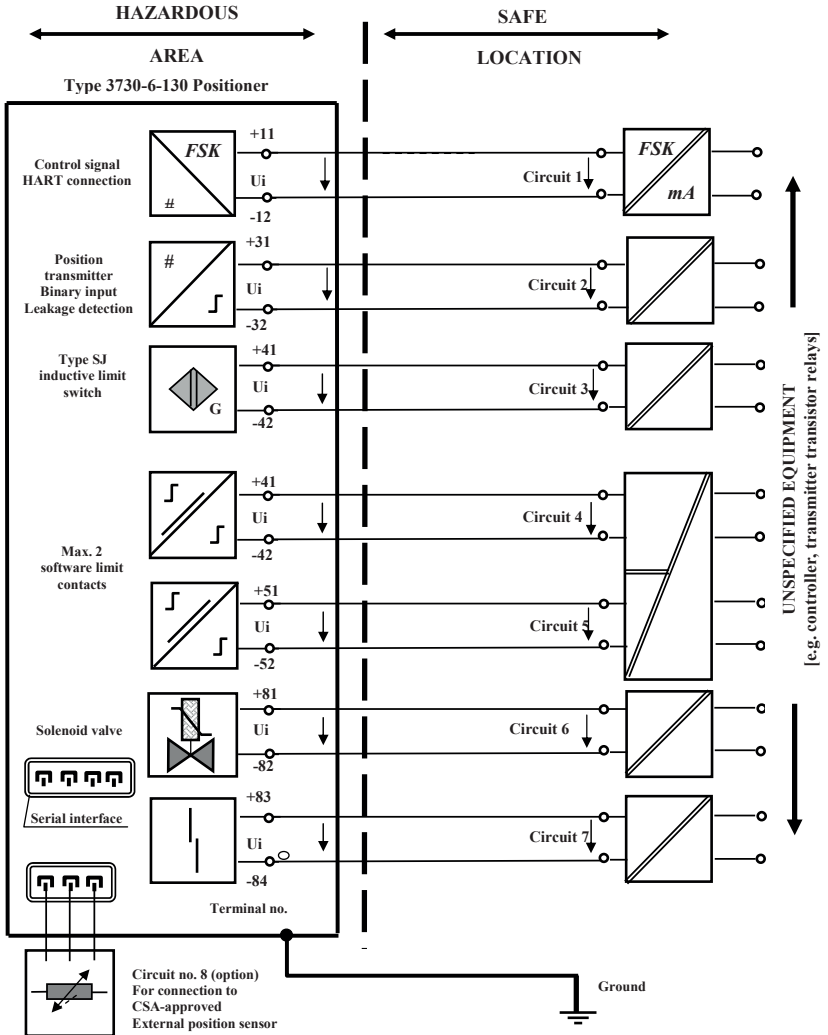

Note!

- 1.) For the maximum values of the individual energy limited circuits see Table 4.
- 2.) Cable entry: only rigid metal conduit according to drawing no. 1050-0540 T

Table 4: Electrical rating of energy-limited circuits (non-incendive) parameters

	HART connection	Position transmitter	Binary input	Leakage sensor	Limit contacts		Solenoid valve	Fault alarm output
					Inductive	Software		
Circuit no.	1	2			3	4 and 5	6	7
Terminal no.	11/12	31/32			41/42	41/42 51/52	81/82	83/84
U_i or V_{max} [V]	32	32	32	###	20	20	32	20
I_i or I_{max} [mA]	132	132	132	###	25/52	60	132	60
P_i or P_{max} [W]	1.2	1.2	###	###	64/169	400	1.2	400
C_i	5.3 nF	5.3 nF	56.3 nF	5.3 nF	30 nF	5.3 nF	5.3 nF	5.3 nF
L_i	0 μ H	0 μ H	0 μ H	C0 1.4 nF	100 μ H	0 μ H	0 μ H	0 μ H
Circuit	Serial interface BU				External position sensor ($R_i \geq 10 \text{ K}\Omega$ passive)			
Terminal	Connector				Analog PCB pin p9, p10, p11/external connector			
U_i or V_{max} [V]	20 V	U_0 or V_{0C}	7.88 V	U_0 or V_{0C}	7.88 V			
I_i or I_{max} [mA]	60 mA	I_0 or I_{SC}	69.2 mA	I_0 or I_{SC}	13.2 mA			
P_i or P_{max} [W]	400 mW	P_0 or P_{max}	137 mW	P_0 or P_{max}	27 mW			
C_i	0 nF	C_0	10 μ F	C_0	10 μ F	$C_i=66 \text{ nF}$		
L_i	0 μ H	L_0	10 mH	L_0	10 mH	$L_i=370 \text{ }\mu\text{H}$		

Installation drawing: control relay KHA5-OTI/Ex2, KHA6-OTI/Ex1 or
KHA6-OTI/Ex2 with Type SJ-b-N proximity switch

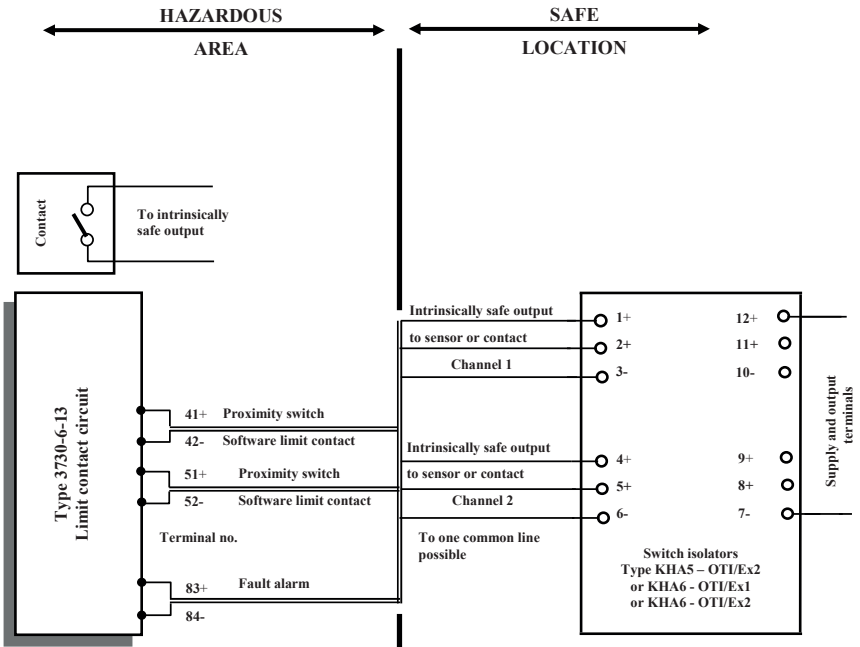

Control relay Terminal no.	Groups	L [mH]	C [μF]	V _{0C} [V]	I _{SC} [mA]
1-3; 2-3 4-6; 5-6	A + B	84.8	1.27	↑ 12.9	↑ 19.8
	C	299	3.82		
	D	744	10.2	↓	↓

16 Appendix A (configuration instructions)

16.1 Parameters and functions

Code no.	Parameter – Readings/values [default setting]	Description
Note: Codes marked with an asterisk (*) must be enabled with Code 3 prior to configuration.		
0	Operating mode [MAN] Manual mode AUTO Automatic mode SAFE Fail-safe position ESC Cancel	Switchover from automatic to manual mode is bumpless. Automatic mode only possible if positioner has been initialized. Reading: Code 0
1	Manual set point (manual w) [0] to 100 % of the nominal range	Adjust the manual set point with the rotary pushbutton. The current travel/angle is displayed in % when the positioner is initialized. If the positioner is not initialized, the position of the lever in relation to the longitudinal axis is indicated in degrees (°). Note: can only be selected when Code 0 = MAN
2	Reading direction 1234, ꞖꞗꞘꞙ, ESC	The reading direction of the display is turned by 180°.
3	Enable configuration [No], YES, ESC	Enables changing of data (automatically deactivated when the rotary pushbutton has not been operated for 120 seconds). Codes marked with an asterisk (*) can only be read and not overwritten when their configuration is not enabled. HART blinks on the display when the on-site operation is locked over HART® communication. PST is displayed when the on-site operation is locked by the time-controlled partial stroke test. In these cases, codes can only read over the SSP interface.
4*	Pin position [No], 17, 25, 35, 50, 70, 100, 200 mm, 90° with rotary actuators, 300 mm with piston actuators, ESC	When attaching the positioner to the control valve, the follower pin must be inserted in the proper pin position on the lever depending on the travel/angle. For initialization using NOM (nominal range) or SUB (substitute calibration), the pin position must be entered. For initialization using MAX, MAN and MAN2, the pin position is not required, however, it is required under Code 5 to display the nominal range.

Appendix A (configuration instructions)

Code no.	Parameter – Readings/ values [default setting]	Description																											
4*	Pin position (continued) <i>If you select a pin position in Code 4 that is too small, the positioner switches to SAFE mode for reasons of safety.</i>	<table border="1"> <thead> <tr> <th>Pin position Code 4</th> <th>Standard Code 5</th> <th>Adjustment range Code 5</th> </tr> </thead> <tbody> <tr> <td>17</td> <td>7.5</td> <td>3.6 to 17.7</td> </tr> <tr> <td>25</td> <td>7.5</td> <td>5.0 to 25.0</td> </tr> <tr> <td>35</td> <td>15.0</td> <td>7.0 to 35.4</td> </tr> <tr> <td>50</td> <td>30.0</td> <td>10.0 to 50.0</td> </tr> <tr> <td>70</td> <td>40.0</td> <td>14.0 to 70.7</td> </tr> <tr> <td>100</td> <td>60.0</td> <td>20.0 to 100.0</td> </tr> <tr> <td>200</td> <td>120.0</td> <td>40.0 to 200.0</td> </tr> <tr> <td>90°</td> <td>90.0</td> <td>24.0 to 100.0</td> </tr> </tbody> </table>	Pin position Code 4	Standard Code 5	Adjustment range Code 5	17	7.5	3.6 to 17.7	25	7.5	5.0 to 25.0	35	15.0	7.0 to 35.4	50	30.0	10.0 to 50.0	70	40.0	14.0 to 70.7	100	60.0	20.0 to 100.0	200	120.0	40.0 to 200.0	90°	90.0	24.0 to 100.0
Pin position Code 4	Standard Code 5	Adjustment range Code 5																											
17	7.5	3.6 to 17.7																											
25	7.5	5.0 to 25.0																											
35	15.0	7.0 to 35.4																											
50	30.0	10.0 to 50.0																											
70	40.0	14.0 to 70.7																											
100	60.0	20.0 to 100.0																											
200	120.0	40.0 to 200.0																											
90°	90.0	24.0 to 100.0																											
5*	Nominal range [15.0] mm or angle °, ESC	<p>For initialization using NOM (nominal range) or SUB (substitute calibration), the nominal range must be entered. The possible adjustment range depends on the pin position from the table for Code 4.</p> <p>After initialization to the maximum range (MAX), the maximum rated travel/angle reached on initialization is displayed.</p>																											
6*	Initialization mode (init mode) [MAX], NOM, MAN, MAN2, SUB, KP, ZP, ESC	<p>MAX: Maximum range · For simple start-up of valves with two clearly defined mechanical end positions · The positioner determines travel/angle of rotation of the closing member from the CLOSED position to the opposite stop in the actuator</p> <p>NOM: Nominal range · For all globe valves · The positioner determines travel/angle of rotation of the closing member from the CLOSED position to the specified nominal range</p> <p>MAN: Manual setting 1 · For all globe valves with unknown nominal range (OPEN position) · The positioner determines travel/angle of rotation from the manually selected OPEN position (100 %) to the CLOSED position</p> <p>MAN2: Manual setting 2 · For all globe valves with unknown nominal range (OPEN and CLOSED position) · The positioner determines travel/angle of rotation between the manually selected OPEN (100 %) and the manually selected CLOSED position (0 %)</p> <p>SUB: Substitute calibration · To replace a positioner while the plant is running, with the least amount of disruption to the plant</p>																											

Code no.	Parameter – Readings/ values [default setting]	Description
6*	Initialization mode (init mode) (continued)	KP: Fine tuning of the input filter · The valve moves through its entire valve range. NP: Zero calibration · The zero point is recalibrated. <i>Note: Valve will temporarily be moved from its operating point to CLOSED position.</i>
7*	Direction of action (w/x) [↗↗, ↘↘, ESC]	Set point's effect on the valve position ↗↗: Increasing/increasing: a globe valve opens as the set point increases. ↘↘: Increasing/decreasing: a globe valve closes as the set point increases. The direction of action is adapted to the change in closed direction as follows: ATO: AIR TO OPEN · On completing initialization, the direction of action remains increasing/increasing (↗↗). A globe valve opens as the reference variable increases. ATC: AIR TO CLOSE · On completing initialization, the direction of action changes to increasing/decreasing (↘↘). A globe valve closes as the mA signal increases.
8*	Travel/angle range start (lower x-range value) [0.0] to 80.0 % of the nominal range, ESC <i>Specified in mm or angle ° provided Code 4 is activated.</i>	Lower range value for the travel/angle of rotation in the operating range. Nominal range and characteristic are automatically adapted. The operating range is the actual travel/angle of the valve and is limited by the lower travel/angle range value (Code 8) and the upper travel/angle range value (Code 9). Usually, the operating range and the nominal range are identical. The nominal range can be limited to the operating range by the lower and upper travel/angle range values. The value is displayed or must be entered. See also the example in Code 9.

Appendix A (configuration instructions)

Code no.	Parameter – Readings/values [default setting]	Description
9*	<p>Travel/angle range end (upper x-range value) 20.0 to [100.0 %] of the nominal range, ESC <i>Specified in mm or angle ° provided Code 4 is activated.</i></p>	<p>Upper range value for the travel/angle of rotation in the operating range. Nominal range and characteristic are automatically adapted. Example: The operating range is modified, for example to limit the range of a control valve which has been sized too large. For this function, the entire resolution range of the set point is converted to the new limits. 0 % on the display corresponds to the adjusted lower limit and 100 % to the adjusted upper limit.</p>
10*	<p>Lower travel/angle limit (lower x-limit) 0.0 to 49.9 % of the operating range, [No], ESC</p>	<p>Lower limitation of the travel/angle of rotation to the entered value. The characteristic is not adapted.</p>
11*	<p>Upper travel/angle limit (upper x-limit) 50.0 to 120.0 %, [100 %] of the operating range, No, ESC</p>	<p>Upper limitation of the travel/angle of rotation to the entered value. The characteristic is not adapted. Example: In some applications, it is better to limit the valve travel, e.g. if a certain minimum medium flow is required or a maximum flow must not be reached. The lower limit must be adjusted with Code 10 and the upper limit with Code 11. If a tight-closing function has been set up, it has priority over the travel limitation. When set to No, the valve can be opened past the rated travel with a set point outside of the 4 to 20 mA range.</p>
12*	<p>Set point range start (w-start) [0.0] to 75.0 %, ESC</p>	<p>Lower range value (0 % = 4 mA) of the valid set point range. This value must be smaller than the upper range value. The set point range is the difference between Set point, upper range value – Set point, lower range value. The difference must be larger or equal to 25 % (= 4 mA). When the set point range of 0 to 100 % = 4 to 20 mA, the valve moves through its entire operating range from 0 to 100 % travel/angle of rotation. In split-range operation, the valves operate with smaller set points. The control signal of the control unit to control two valves is divided such, for instance, that the valves move through their full travel/angle of rotation at only half the input signal (first valve set to 0 to 50 % = 4 to 12 mA and second valve set to 50 to 100 % = 12 to 20 mA).</p>

Code no.	Parameter – Readings/values [default setting]	Description
13*	Set point end (w-end) 25.0 to [100.0] %, ESC	Upper range value (100 % = 20 mA) of valid set point range This value must be greater than the lower range value.
14*	CLOSED end position/set point cutoff decrease (end position w <) 0.0 to 49.9 %, [1.0 %] of the span adjusted in Code 12/13, No, ESC	Limit of the set point w Actuators with ATO fail-safe action are completely vented and actuators with ATC fail-safe action are completely filled with air when the set point falls below the adjusted limit. This action always lead to the tight-closing of the valve. Codes 14/15 have priority over Codes 8/9/10/11. Codes 21/22 have priority over Codes 14/15.
15*	OPEN end position/set point cutoff increase (end position w >) 50.0 to 100.0 % of the span adjusted in Code 12/13, [No], ESC	Limit of the set point w Actuators with ATO fail-safe action are completely filled with air and actuators with ATC fail-safe action are completely vented when the set point falls below the adjusted limit. This action always lead to the valve to be opened to the maximum. Codes 14/15 have priority over Codes 8/9/10/11. Codes 21/22 have priority over Codes 14/15. Example: set the cutoff to 99 % for three-way valves.
16*	Pressure limit 1.4 to 7.0 bar, [No], ESC <i>Do not activate pressure limitation for double-acting actuators (with closed position ATO).</i>	Signal pressure to actuator can be limited. After changing the pressure limit setting, the actuator must be vented once (e.g. by selecting the fail-safe position).
17*	Proportional-action coefficient Kp level 0 to 17 [7], ESC <i>Kp level changes affect the set point deviation. This effect can be compensated for by tuning the input filter in Code 6.</i>	During positioner initialization, the values for Kp and Tv are optimally set. If the value for the KP level is below 3, the error code 61 is activated. If the positioner tends to overshoot impermissibly due to other disturbances, the KP and TV levels can be adapted accordingly after initialization. Increment TV level until desired behavior is reached or when the maximum value of 4 is reached, the KP level can be decreased in increments.
18*	Derivative-action time Tv level 1, [2], 3, 4, No, ESC	See Code 19 A change of the TV level has no effect on the set point deviation.

Appendix A (configuration instructions)

Code no.	Parameter – Readings/values [default setting]	Description
19*	Tolerance band 0.1 to 10.0 %, [5.0 %] of the operating range, ESC	Used for error monitoring. If the set point deviation is greater than selected tolerance band for a time longer than the lag time [30 s], this causes the error code 57 (control loop) to be activated. Note: <i>The lag time can only be set using the operator software.</i>
20*	Select characteristic [0] to 9, ESC	Characteristic selection (see Chapter 16.2) 0 Linear 1 Equal percentage 2 Reverse equal percentage 3 SAMSON butterfly valve, linear 4 SAMSON butterfly valve, equal percentage 5 VETEC rotary plug valve, linear 6 VETEC rotary plug valve, equal percentage 7 Segmented ball valve, linear 8 Segmented ball valve, equal percentage 9 User-defined (defined over operator software)
21*	Transit time OPEN (w ramp OPEN) [0] to 240 s, ESC <i>The entered transit time does not apply when fail-safe action, solenoid valve or forced venting function are triggered nor when the auxiliary energy fails.</i>	The time required to move through the operating range when opening the valve. This parameter can be used to increase the Min. transit time OPEN (Code 40). Limitation of the transit time (Code 21 and 22): For some applications it is recommendable to limit the transit time of the actuator to prevent it from engaging too fast in the running process. Code 21 has priority over Code 15.
22*	Transit time CLOSED (w ramp CLOSED) [0] to 240 s, ESC <i>The entered transit time does not apply when fail-safe action, solenoid valve or forced venting function are triggered nor when the auxiliary energy fails.</i>	The time required to move through the operating range when closing the valve. This parameter can be used to increase the Min. transit time CLOSED (Code 41). Code 22 has priority over Code 14.

Code no.	Parameter – Readings/values [default setting]	Description
23*	Absolute total valve travel [0] to $99 \cdot 10^7$, YES, ESC Exponential reading from 9999 travel cycles onwards	Totaled full valve travel cycle Can be reset to 0 in Code 36 – STD and Code 36 – DS. Note: <i>The total valve travel is saved in a non-volatile memory every 24 hours.</i>
24*	Total valve travel limit 1000 to $99 \cdot 10^7$ [1.000000], ESC Exponential reading from 9999 travel cycles onwards	Limit of total valve travel limit 'Total valve travel exceeded' message is generated depending on selected status classification if the limit is exceeded. Note: <i>The 'Total valve travel exceeded' message has the default status classification 'Maintenance required'. This classification can only be changed in the operator software (e.g. TROVIS-VIEW).</i>
25*	Alarm mode 0, 1, [2], 3, ESC	Switching mode of software limit switch alarms A1 and A2 when activated (when the positioner is initialized). Explosion-protected version according to EN 60947-5-6 0: A1 ≥ 2.2 mA A2 ≤ 1.0 mA 1: A1 ≤ 1.0 mA A2 ≤ 1.0 mA 2: A1 ≥ 2.2 mA A2 ≥ 2.2 mA 3: A1 ≤ 1.0 mA A2 ≥ 2.2 mA Version without explosion protection 0: A1 R = 348 Ω A2 non-conducting 1: A1 non-conducting A2 non-conducting 2: A1 R = 348 Ω A2 R = 348 Ω 3: A1 non-conducting A2 R = 348 Ω When a positioner has not been initialized, the software limit switches always register the signal as in the state of no response. If there is no mA signal at the terminals 11/12, the software limit switches both switch to ≤ 1.0 mA (Ex) or non-conducting (without explosion protection). Note: <i>The fault alarm output always switches to ≤ 1.0 mA/non-conducting in case of a fault; it has ≥ 2.2 mA/R = 348 Ω when there is no fault.</i>
26*	Limit A1 (alarm limit 1) 0.0 to 100.0 [2.0] % of the operating range, No, ESC <i>The setting has no effect when an inductive limit switch is installed.</i>	The valve position limit relating to the operating range. Alarm A1 responds when the value falls below the limit.

Appendix A (configuration instructions)

Code no.	Parameter – Readings/ values [default setting]	Description
27*	Limit A2 (alarm limit 2) 0.0 to 100.0 [98.0] % of the operating range, No, ESC	The valve position limit relating to the operating range. Alarm A2 responds when the value falls below the limit.
28*	Alarm test Reading direction: Standard Turned [No] [No] A1 1A A2 2A A3 3A ESC ESC	Testing the software limit switch alarm A1 and A2 as well as the fault alarm contact A3. If the test is activated, the contact is switched five times. A1/1A: Software limit switch A1 to ≥ 2.2 mA A2/2A: Software limit switch A2 to ≥ 2.2 mA A3/3A: Fault alarm contact A3 to ≤ 1.0 mA
29*	Position transmitter x/ix ³⁾ [↗↗], ↗↘, ESC	Operating direction of the position transmitter: it indicates assignment between travel/angle position and output signal i based on CLOSED position. The operating range (see Code 8) of the valve is represented by the 4 to 20 mA signal. Values exceeding or falling below the limits 2.4 mA or 21.6 mA can be represented. When a positioner has not been connected (set point w less than 3.6 mA), the signal is 0.9 mA and 3.8 mA or 4.4 mA when the positioner has not been initialized. When Code 32 = YES, the position transmitter issues the value as set in Code 30 during initialization or zero calibration. When Code 32 = No, 4 mA is issued during a running autotune.
30*	Fault alarm ix ³⁾ [No], HI, LO, ESC	Select if and how faults that cause the fault alarm contact to be switched are also indicated at the position transmitter output. HI ix = 21.6 ± 0.1 mA or LO ix = 2.4 ± 0.1 mA
31*	Position transmitter test ³⁾ -10.0 to 110.0 % of the operating range · ESC, [default value is last indicated value of the position transmitter]	Testing the position transmitter. Values can be entered in relation to the operating range. The momentary valve position is used in initialized positioners locally as the start value (bumpless changeover to the test mode). When testing by software, the entered simulation value is issued as the position feedback signal for 30 seconds.

³⁾ Analog position transmitter: Code 29/30/31 can only be selected if the position transmitter (optional) is installed.

Code no.	Parameter – Readings/ values [default setting]	Description
32*	Error message in case of 'Function check' condensed state [YES], No, ESC	<p>YES: 'Failure' and 'Function check' condensed state cause an error message to be generated.</p> <p>No: 'Failure' condensed state causes an error message to be generated.</p>
33*	Error message in case of 'Maintenance required' and 'Out of specification' condensed states [YES], No, ESC	<p>YES: 'Failure', 'Maintenance required' and 'Out of specification' condensed state cause an error message to be generated.</p> <p>No: 'Failure' condensed state causes an error message to be generated.</p>
34*	Closing direction CL, [CCL], ESC	<p>CL: Clockwise</p> <p>CCL: Counterclockwise</p> <p>Direction of rotation to reach the valve's CLOSED position (view onto rotary switch with positioner cover open).</p> <p>Note: Needs only be entered in SUB initialization mode (Code 6).</p>
35*	Blocking position [0.0] mm/° /%, ESC	<p>Distance to CLOSED position</p> <p>Note: Needs only be entered in SUB initialization mode (Code 6).</p>
36*	Reset	<p>STD: Resets start-up</p> <ul style="list-style-type: none"> – Resets parameters to their default settings. – Resets diagnostics assessment. – Information parameters (read only) remain unchanged. – Re-initialize positioner. <p>DAG: Reset diagnostics assessment</p> <ul style="list-style-type: none"> – Parameter settings, reference values and logs remain unchanged. – The positioner does not need to be re-initialized. <p>DS: Resets positioner to default settings.</p> <ul style="list-style-type: none"> – Resets parameters to their default settings. – Resets diagnostics assessment. – Information parameters (read only) are deleted. – Re-initialize positioner.
36*	STD, DIAG, DS, ESC	

Appendix A (configuration instructions)

Code no.	Parameter – Readings/values [default setting]	Description
37	Options Read only	Indicates which option (terminals 31 and 32, Fig 17) is installed. No: No option installed POS: Analog position transmitter dl: Binary input LS: Leakage sensor XI: 4 to 20 mA x input When the binary input is used, DI and HIGH or LOW status are displayed in alternating sequence. When the leakage sensor is used, LS and the detected sound level in dB are displayed in alternating sequence.
38*	Inductive limit switch [No], YES, ESC	Indicates whether the inductive limit switch option is installed or not.
39	Set point deviation e info Read only	Difference of the target position ($e = w - x$)
40	Min. transit time OPEN Read only	Minimum opening time determined during initialization
41	Min. transit time CLOSED Read only	Minimum closing time determined during initialization
42	Set point Read only	Set point w used in automatic mode 4 to 20 mA correspond to 0 to 100 %
43	Firmware version Read only	Device type and current firmware version (displayed in alternating sequence)
44	y info Read only	Control signal y in % in relation to the travel range determined during initialization MAX: The positioner builds up its maximum output pressure, see description in Code 14 and 15. OP: The positioner vents completely, see description in Code 14 and 15. -- -: The positioner is not initialized.

Code no.	Parameter – Readings/values [default setting]	Description
45	Internal solenoid valve/forced venting Read only	Indicates whether a solenoid valve/forced venting is installed or not. If a voltage supply is connected at the terminals +81/-82, YES and HIGH appear on the display in alternating sequence. If a voltage supply is not connected (actuator vented, fail-safe position indicated on the display by the S icon), YES and LOW appear on the display in alternating sequence.
46*	Bus address [0] to 15, ESC	Using the HART® protocol, all connected control room and field units can be addressed individually using a point-to-point connection or the standard (multidrop) bus. Point-to-point connection: HART® master device connected to one HART® field unit. With this connection, the device address must also be set to '0'. Standard (multidrop) bus: Up to 15 field units connected in parallel to a single pair of wires. The master device distinguishes them by their preset addresses between 1 and 15.
47*	HART® write protection YES, [No], ESC	When write protection is active, device data can be read, but not overwritten over HART® communication.
48* 49*	Diagnostic parameters · Details on EXPERTplus Valve Diagnostics in the Operating Instructions ▶ EB 8389-1.	

16.1.1 Error codes

Initialization errors

Error codes – Recommended action		Condensed state message active, when prompted, ERR appears. When fault alarms exist, they are displayed here.
50	x > range	<p>Value of measuring signal too high or too low; the lever operates near its mechanical stops.</p> <ul style="list-style-type: none"> • Pin not mounted properly • NAMUR attachment: bracket slipped or follower pin not properly seated on the follower plate's slot. • Follower plate not mounted properly.
	Status classification	[Maintenance required]
	Recommended action	<ul style="list-style-type: none"> • Check attachment and pin position. • Re-initialize positioner.
51	$\Delta x < \text{range}$	<p>Insufficient measuring span of the sensor</p> <ul style="list-style-type: none"> • Pin not mounted properly. • Wrong lever mounted. • Pressure limit set too low. <p>An angle of rotation smaller than 16° at the positioner shaft only generates an alarm. An angle below 9° leads to the initialization being canceled.</p>
	Status classification	[Out of specification]
	Recommended action	<ul style="list-style-type: none"> • Check attachment and pressure limit. • Re-initialize positioner.
52	Attachment	<ul style="list-style-type: none"> • The nominal range could not be achieved during initialization with NOM initialization mode (the maximum travel/angle reached is indicated on the display). • Wrong lever mounted. • Supply pressure too low; valve cannot be moved to desired position.
	Status classification	[Maintenance required]
	Recommended action	<ul style="list-style-type: none"> • Check attachment and supply pressure. • Re-initialize positioner.

Error codes – Recommended action		Condensed state message active, when prompted, <i>ERR</i> appears. When fault alarms exist, they are displayed here.
53	Initialization time exceeded (initialization time >)	Timeout detected during initialization <ul style="list-style-type: none"> • Valve takes too long to open. • Valve cannot find fixed end stops (e.g. when lined control butterfly valves are used). • Valve tends to hunt considerably.
	Status classification	[Maintenance required]
	Recommended action	<ul style="list-style-type: none"> • Check supply pressure and install pneumatic volume booster, if necessary. • Adjust travel/angle stops. • Reduce hunting tendency (e.g. restrict or open booster bypass). Re-initialize the positioner.
54	Initialization - Internal solenoid valve/forced venting	<ol style="list-style-type: none"> 1) Internal solenoid valve/forced venting not or improperly connected. 2) An attempt was made to initialize the device from fail-safe position.
	Status classification	[Maintenance required]
	Recommended action	<ol style="list-style-type: none"> 1) Check connection and supply voltage of solenoid valve/forced venting. Re-initialize positioner. 2) Switch to manual mode. Re-initialize positioner.
55	Transit time not reached (transit time <)	Actuator transit times detected during initialization are so short (< 0.3 s) that optimal positioner tuning is impossible.
	Status classification	[Out of specification]
	Recommended action	<ul style="list-style-type: none"> • Activate volume restriction in positioner output. • Re-initialize positioner.
56	Pin/switch position	<ol style="list-style-type: none"> 1) Pin position not entered for nominal range (NOM) or substitute (SUB) initialization. 2) ATO/ATC switch defective.
	Status classification	[Maintenance required]
	Recommended action	<ol style="list-style-type: none"> 1) Enter pin position and nominal range. Re-initialize positioner. 2) Return positioner to SAMSON for repair.

Appendix A (configuration instructions)

Operational errors

Error codes – Recommended action		Condensed state message active, when prompted, <i>Err</i> appears. When fault alarms exist, they are displayed here.
57	Control loop Additional indication at the fault alarm contact	Control loop error, the valve no longer follows the controlled variable within tolerable times (tolerance band alarm Code 19). <ul style="list-style-type: none"> • Actuator is blocked. • Positioner attachment has shifted subsequently. • Insufficient supply pressure
	Status classification	[Maintenance required]
	Recommended action	<ul style="list-style-type: none"> • Check attachment. • Check supply pressure.
58	Zero point	<ul style="list-style-type: none"> • Mounting arrangement or linkage has slipped. • Valve trim, particularly with soft seat, is worn.
	Status classification	[Maintenance required]
	Recommended action	<ul style="list-style-type: none"> • Check valve and positioner attachment. • Calibrate zero. <p>We recommend to re-initialize the positioner if zero deviates by more than 5 %.</p>
59	Inconsistent data memory	The error is detected by automatic monitoring and corrected automatically.
	Status classification	Failure (cannot be classified)
60	Internal device error Additional indication at the fault alarm contact	The positioner goes to the fail-safe position (SAFE).
	Status classification	Failure (cannot be classified)
	Recommended action	Return positioner to SAMSON for repair.
61	Kp too low	Proportional-action coefficient K_p level lower than 3 was detected during initialization. Note: A K_p level < 3 does not cause the initialization process to be canceled.
	Status classification	[Maintenance required]
	Recommended action	<ul style="list-style-type: none"> • Activate volume restriction in positioner output. • Increase the bypass restriction setting of booster (if installed).

Hardware errors

Error codes – Recommended action		Condensed state message active, when prompted, <i>Err</i> appears. When fault alarms exist, they are displayed here.
62	x signal Additional indication at the fault alarm contact	<ul style="list-style-type: none"> Actuator's measured value recording failed. Conductive plastic element defective. <p>The emergency mode on the display is indicated by a blinking closed-loop operation icon and 4 dashes instead of the position reading.</p> <p>Note on the open-loop operation: If the measuring system has failed, the positioner is still in a reliable state. The positioner switches to emergency mode where the position cannot be accurately controlled anymore. However, the positioner continues operation according to its set point so that the process remains in a safe state.</p>
	Status classification	[Maintenance demanded]
	Recommended action	Return positioner to SAMSON for repair.
63	SIL shutdown/w too low	<ol style="list-style-type: none"> Emergency shutdown of the i/p block is implemented by 3.8 mA or 4.4 mA (depending on the positioner version)'. The set point w is lower than 3.7 mA. This state is indicated on the positioner display by LOW blinking.
	Status classification	[No message]
	Recommended action	<ol style="list-style-type: none"> Raise the current (depending on version) above the limit. Check set point w. If necessary, restrict lower limit of current source to ensure that a current below 3.7 mA cannot be issued.
64	i/p converter (y)	Current circuit of i/p converter interrupted.
	Status classification	Failure (cannot be classified)
	Recommended action	Return positioner to SAMSON for repair.

Appendix A (configuration instructions)

Error appendix

Error codes – Recommended action		Condensed state message active, when prompted, Err appears. When fault alarms exist, they are displayed here.
65	Hardware Additional indication at the fault alarm contact	<ul style="list-style-type: none">• Initialization key jammed.• A hardware error has occurred. The positioner changes to the fail-safe position (SAFE). As long as the error exists, no EXPERTplus diagnostic messages are logged.
	Status classification	[Failure]
	Recommended action	Confirm error and return to automatic mode or perform a reset and re-initialize the positioner. In the problem still persists, return device to SAMSON for repair.
66	Unassigned	
67	Check calculation Additional indication at the fault alarm contact	Hardware controller monitored by test calculation.
	Status classification	[Failure]
	Recommended action	Confirm error. If this is not possible, return the device to SAMSON for repair.

Data errors

Error codes – Recommended action		Condensed state message active, when prompted, <i>Err</i> appears. When fault alarms exist, they are displayed here.
68 to 71	Unassigned	
72	Pressure sensor	Pressure sensor for supply air and/or pressure sensor for signal pressure defective
	Status classification	Maintenance required (cannot be classified)
	Recommended action	Return positioner to SAMSON for repair.
73 to 75	Unassigned	
76	No emergency mode	The travel measuring system of the positioner has a self-monitoring function (see Code 62). An emergency mode (open-loop control) is not available for certain actuators, such as double-acting actuators. In case of a travel sensing error, the positioner vents the output (Output 38) or A1 in double-acting actuators. During the initialization, the positioner automatically checks whether the actuator has such a function or not.
	Status classification	[No message]
	Recommended action	Merely information, confirm, if necessary. No further action required.

Diagnosis errors

Error codes – Recommended action		Condensed state message active, when prompted, <i>Err</i> appears. When fault alarms exist, they are displayed here.
77	Unassigned	
78	Unassigned	
79	Collective error	Messages generated in EXPERTplus The error does not have any direct effect on the positioner's functioning.
	Status classification	Maintenance required (cannot be classified)
80	Unassigned	

Appendix A (configuration instructions)

Error codes – Recommended action		Condensed state message active, when prompted, Err appears. When fault alarms exist, they are displayed here.
81	Valve signature canceled	Error during automatic plotting of the valve signature Error messages are not yet saved in a non-volatile memory. They cannot be reset.
	Status classification	[Maintenance required]
	Recommended action	Restart the valve signature recording or start initialization including valve signature.
82	Unassigned	
83	Unassigned	
84	PST/FST	A partial stroke test or full stroke test cannot be started or has been canceled.
	Status classification	[No message]
	Recommended action	Read out test status (only in the operator software)
85	On/off valve	The transit time and breakaway time or the final travel/angle value of the on/off valve has changed.
	Status classification	[No message]
	Recommended action	Check valve and actuator.

16.2 Selecting the characteristic

The characteristics that can be selected in Code 20 are shown in the following in graph form.

i Note

A characteristic can only be defined (user-defined characteristic) using a workstation/operating software (e.g. TROVIS-VIEW).

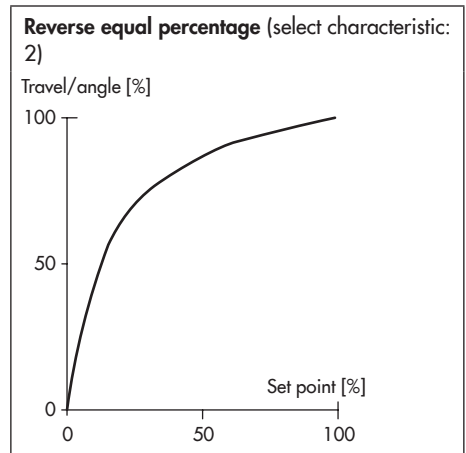
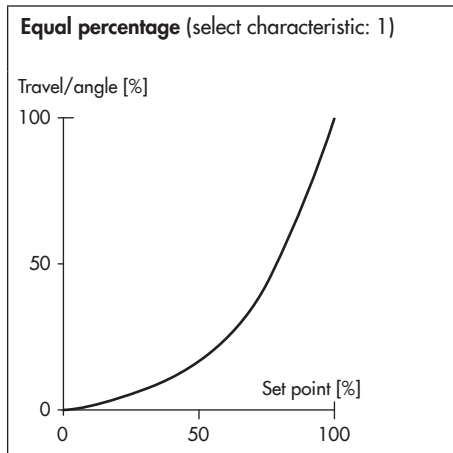
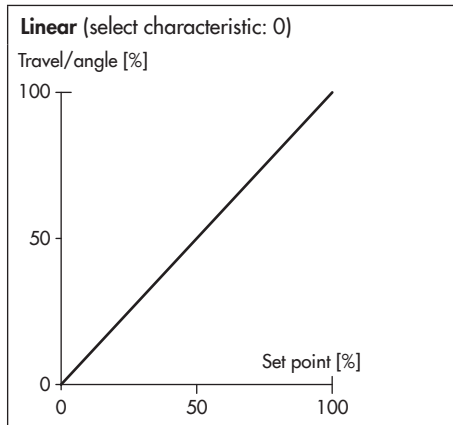

SAMSON butterfly valve linear (select characteristic: 3)

Travel/angle [%]
100
50
0

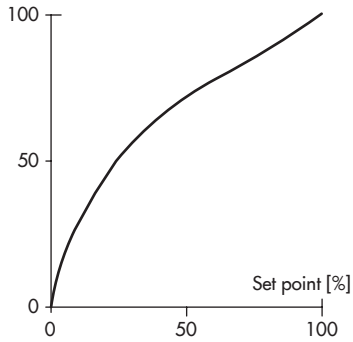

SAMSON butterfly valve equal percentage (select characteristic: 4)

Travel/angle [%]
100
50
0

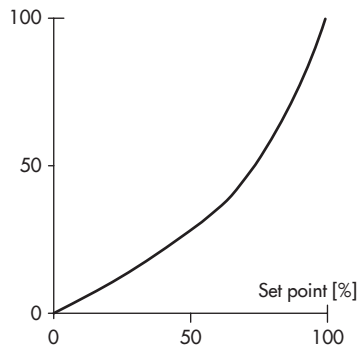

VETEC rotary plug valve linear (select characteristic: 5)

Travel/angle [%]
100
50
0

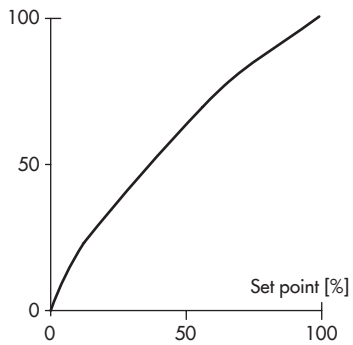

VETEC rotary plug valve equal percentage (select characteristic: 6)

Travel/angle [%]
100
50
0

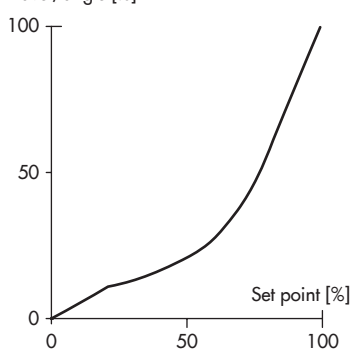

Segmented valve ball linear (select characteristic: 7)

Travel/angle [%]
100
50
0

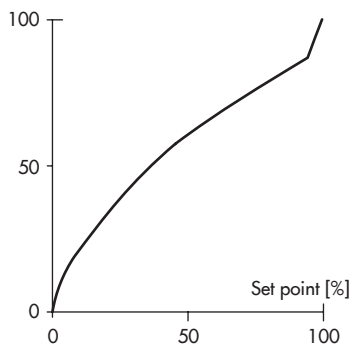

Segmented valve ball equal percentage (select characteristic: 8)

Travel/angle [%]
100
50
0

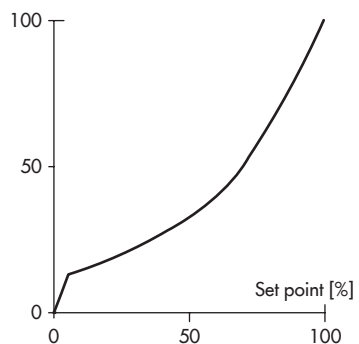

17 Appendix B

17.1 Accessories

Table 17-2: *General accessories*

Designation		Order no.
Reversing amplifier for double-acting actuators		Type 3710
Cable gland M20x1.5	Black plastic (6 to 12 mm clamping range)	8808-1011
	Blue plastic (6 to 12 mm clamping range)	8808-1012
	Nickel-plated brass (6 to 12 mm clamping range)	1890-4875
	Nickel-plated brass (10 to 14 mm clamping range)	1922-8395
	Stainless steel 1.4305 (8 to 14.5 mm clamping range)	8808-0160
Adapter M20x1.5 to ½ NPT	Powder-coated aluminum	0310-2149
	Stainless steel	1400-7114
Lever	S	0510-0522
	M	0510-0510
	L	0510-0511
	XL	0510-0512
	XXL	0510-0525
Retrofit kit for inductive limit switch 1 x SJ2-SN		1402-1770
Isolated USB interface adapter (SSP interface to USB port on a computer) inc. TROVIS-VIEW CD-ROM		1400-9740
Serial interface adapter (SAMSON SSP interface to RS-232 port on a computer)		1400-7700
TROVIS-VIEW 6661 ► www.samsongroup.com > DOWNLOADS > Software & Drivers > TROVIS-VIEW		

Table 17-3: *Direct attachment to Type 3277-5 Actuator*

Designation		Order no.
Mounting parts	Standard version for actuators 120 cm ² or smaller	1400-7452
	Version compatible with paint for actuators 120 cm ² or smaller	1402-0940
Accessories for actuator	Old switchover plate for Type 3277-5xxxxxx.00 Actuator (old)	1400-6819
	New switchover plate for Type 3277-5xxxxxx.01 Actuator (new) ¹⁾	1400-6822
	New connecting plate for Type 3277-5xxxxxx.01 Actuator (new) ¹⁾ , G ½ and ½ NPT	1400-6823
	Old connecting plate for Type 3277-5xxxxxx.00 Actuator (old): G ½	1400-6820
	Old connecting plate for Type 3277-5xxxxxx.00 (old): ½ NPT	1400-6821

Appendix B

Designation		Order no.	
Accessories for positioner	Connecting plate (6)	G ¼	1400-7461
		¼ NPT	1400-7462
	Pressure gauge bracket (7)	G ¼	1400-7458
		¼ NPT	1400-7459
	Pressure gauge mounting kit (8) up to max. 6 bar (output/supply)	Stainless steel/brass	1402-0938
		Stainless steel/stainless steel	1402-0939

¹⁾ Only new switchover and connecting plates can be used with new actuators (Index 01). Old and new plates are not interchangeable.

Table 17-4: Direct attachment to Type 3277 Actuator

Mounting parts/accessories	Order no.	
Standard version for actuators 175, 240, 350, 355, 700, 750 cm ²	1400-7453	
Version compatible with paint for actuators 175, 240, 350, 355, 700, 750 cm ²	1402-0941	
Connection block with seals and screw	G ¼	1400-8819
	¼ NPT	1402-0901
Pressure gauge mounting kit up to max. 6 bar (output/supply)	Stainless steel/brass	1402-0938
	Stainless steel/stainless steel	1402-0939
Piping with screw fittings ¹⁾	Order no.	
Actuator (175 cm ²), steel	G ¼/G ¾	1402-0970
	¼ NPT/¾ NPT	1402-0976
Actuator (175 cm ²), stainless steel	G ¼/G ¾	1402-0971
	¼ NPT/¾ NPT	1402-0978
Actuator (240 cm ²), steel	G ¼/G ¾	1400-6444
	¼ NPT/¾ NPT	1402-0911
Actuator (240 cm ²), stainless steel	G ¼/G ¾	1400-6445
	¼ NPT/¾ NPT	1402-0912
Actuator (350 cm ²), steel	G ¼/G ¾	1400-6446
	¼ NPT/¾ NPT	1402-0913
Actuator (350 cm ²), stainless steel	G ¼/G ¾	1400-6447
	¼ NPT/¾ NPT	1402-0914
Actuator (355 cm ²), steel	G ¼/G ¾	1402-0972
	¼ NPT/¾ NPT	1402-0979
Actuator (355 cm ²), stainless steel	G ¼/G ¾	1402-0973
	¼ NPT/¾ NPT	1402-0980
Actuator (700 cm ²), steel	G ¼/G ¾	1400-6448
	¼ NPT/¾ NPT	1402-0915
Actuator (700 cm ²), stainless steel	G ¼/G ¾	1400-6449
	¼ NPT/¾ NPT	1402-0916

Mounting parts/accessories		Order no.
Actuator (750 cm ²), steel	G ¼/G ⅜	1402-0974
	¼ NPT/⅜ NPT	1402-0981
Actuator (750 cm ²), stainless steel	G ¼/G ⅜	1402-0975
	¼ NPT/⅜ NPT	1402-0982

1) For "actuator stem retracts" fail-safe action with air purging of the top diaphragm chamber

Table 17-5: Attachment to NAMUR rib or attachment to rod-type yokes ¹⁾ according to IEC 60534-6

Travel in mm	Lever	For actuator	Order no.
7.5	S	Type 3271-5 with 60/120 cm ² on Type 3510 Micro-flow Valve	1402-0478
5 to 50	M ²⁾	Actuators from other manufacturers and Type 3271 with 120 to 750 cm ² effective areas	1400-7454
14 to 100	L	Actuators from other manufacturers and Type 3271 with 1000 and 1400-60 cm ²	1400-7455
30 or 60	L	Type 3271, 1400-120 and 2800 cm ² versions with 30/60 mm travel ³⁾	1400-7466
		Mounting brackets for Emerson and Masoneilan linear actuators (in addition, a mounting kit according to IEC 60534-6 is required depending on the travel). See rows above.	1400-6771
		Valtek Type 25/50	1400-9554
40 to 200	XL	Actuators from other manufacturers and Type 3271 with 1400-120 and 2800 cm ² and with 120 mm travel	1400-7456
Accessories			Order no.
Connecting plate	G ¼		1400-7461
	¼ NPT		1400-7462
Pressure gauge bracket	G ¼		1400-7458
	¼ NPT		1400-7459
Pressure gauge mounting kit up to max. 6 bar (output/supply)	Stainless steel/brass		1402-0938
	Stainless steel/stainless steel		1402-0939

1) 20 to 35 mm rod diameter

2) M lever is mounted on basic device (included in the scope of delivery)

3) In conjunction with Type 3273 Side-mounted Handwheel with 120 mm rated travel, additionally one bracket (0300-1162) and two countersunk screws (8330-0919) are required.

Table 17-6: Attachment according to VDI/VDE 3847-1

Mounting parts		Order no.	
VDI/VDE 3847 interface adapter		1402-0257	
Connecting plate, including connection for air purging of actuator spring chamber	Aluminum	ISO 228/1-G ¼	1402-0268
		¼-18 NPT	1402-0269
	Stainless steel	ISO 228/1-G ¼	1402-0270
		¼-18 NPT	1402-0271
Mounting kit for attachment to SAMSON Type 3277 Actuator with 175 to 750 cm ²		1402-0868	
Mounting kit for attachment to SAMSON Type 3271 Actuator or third-party actuators		1402-0869	
Travel pick-off for valve travel up to 100 mm		1402-0177	
Travel pick-off for 100 to 200 mm valve travel (SAMSON Type 3271 Actuator only)		1402-0178	

Table 17-7: Attachment according to VDI/VDE 3847-2

Designation		Order no.
Mounting parts	Mounting block for PFEIFFER Type 31a (edition 2020+) Rotary Actuators with dummy plate for solenoid valve interface	1402-1645
	Blank plate for solenoid valve interface (sold individually)	1402-1290
	Adapter bracket for Type 3730 (VDI/VDE 3847)	1402-0257
	Adapter bracket for Type 3730 and Type 3710 (DAP/PST)	1402-1590
Accessories for actuator	Shaft adapter AA1	1402-1617
	Shaft adapter AA2	1402-1616
	Shaft adapter AA4	1402-1888

Table 17-8: Attachment to rotary actuators

Mounting parts/accessories	Order no.
Attachment according to VDI/VDE 3845 (September 2010), actuator surface corresponds to fixing level 1	
Size AA1 to AA4, version with CrNiMo steel bracket	1400-7448
Size AA1 to AA4, heavy-duty version	1400-9244
Size AA5, heavy-duty version (e.g. Air Torque 10 000)	1400-9542
Bracket surface corresponds to fixing level 2, heavy-duty version	1400-9526
Attachment for rotary actuators with max. 180° opening angle, fixing level 2	1400-8815 and 1400-9837
Attachment to SAMSON Type 3278 with 160/320 cm ² , CrNiMo steel bracket	1400-7614
Attachment to SAMSON Type 3278 with 160 cm ² and to VETEC Type S160, Type R and Type M, heavy-duty version	1400-9245

Mounting parts/accessories		Order no.
Attachment to SAMSON Type 3278 with 320 cm ² and to VETEC Type S320, heavy-duty version		1400-5891 and 1400-9526
Attachment to Camflex II		1400-9120
Accessories	Connecting plate	G ¼ ¼ NPT
		1400-7461
		1400-7462
	Pressure gauge bracket	G ¼ ¼ NPT
		1400-7458 1400-7459
	Pressure gauge mounting kit up to max. 6 bar (output/ supply)	Stainless steel/brass Stainless steel/stainless steel
		1402-0938 1402-0939

Table 17-9: Attachment of external position sensor

Mounting parts/accessories		Order no.
Template for mounting position sensor on older mounting parts		1060-0784
Direct attachment	Mounting parts for actuator with 120 cm ²	1400-7472
	Connecting plate (9, old) with Type 3277-5xxxxx.00 Actuator	G ⅛ ⅛ NPT
		1400-6820 1400-6821
	Connecting plate (new) with Type 3277-5xxxxx.01 Actuator (new) ¹⁾	1400-6823
	Mounting parts for actuators with 175, 240, 350, 355 and 750 cm ²	1400-7471
NAMUR attachment	Mounting parts for attachment to NAMUR rib using L or XL lever	1400-7468
Attachment to Type 3510 Micro-flow Valve	Mounting parts for Type 3271 Actuator with 60 cm ²	1400-7469
Attachment to rotary actuators	VDI/VDE 3845 (September 2010), see the 'Design and principle of operation' chapter for details.	
	Actuator surface corresponds to fixing level 1	
	Size AA1 to AA4 with follower clamp and coupling wheel, version with CrNiMo steel bracket	1400-7473
	Size AA1 to AA4, heavy-duty version	1400-9384
	Size AA5, heavy-duty version (e.g. Air Torque 10 000)	1400-9992
	Bracket surface corresponds to fixing level 2, heavy-duty version	1400-9974
	SAMSON Type 3278 with 160 cm ² and VETEC Type S160 and Type R, heavy-duty version	1400-9385
	SAMSON Type 3278 with 320 cm ² and VETEC Type S320, heavy-duty version	1400-5891 and 1400-9974

Appendix B

Mounting parts/accessories			Order no.
Accessories for positioner	Connecting plate (6)	G ¼	1400-7461
		¼ NPT	1400-7462
	Pressure gauge bracket (7)	G ¼	1400-7458
		¼ NPT	1400-7459
	Pressure gauge mounting kit up to max. 6 bar (output/supply)	Stainless steel/brass	1402-0938
		Stainless steel/stainless steel	1402-0939
Bracket to mount the positioner on a wall (Note: The other fastening parts are to be provided at the site of installation as wall foundations vary from site to site).			0309-0184

- ¹⁾ Only new connecting plates can be used with new actuators (Index 01). Old and new plates are not interchangeable.

17.2 After-sales service

Contact our after-sales service for support concerning service or repair work or when malfunctions or defects arise.

E-mail contact

You can reach our after-sales service at aftersaleservice@samsongroup.com.

Addresses of SAMSON AG and its subsidiaries

The addresses of SAMSON AG, its subsidiaries, representatives and service facilities worldwide can be found on our website (www.samsongroup.com) or in all SAMSON product catalogs.

Required specifications

Please submit the following details:

- Order number and position number in the order
- Specifications on the nameplate:
 - Supply pressure
 - Explosion protection specifications
 - Input signal
 - Emergency shutdown
 - Features
 - Firmware version
 - Model number
 - Configuration ID
 - Serial number

EB 8384-6 EN



SAMSON AKTIENGESELLSCHAFT

Weismüllerstraße 3 · 60314 Frankfurt am Main, Germany

Phone: +49 69 4009-0 · Fax: +49 69 4009-1507

samson@samsongroup.com · www.samsongroup.com