

**Automation System TROVIS 5100
Control and Processing Unit
TROVIS 5171**



Mounting and Operating Instructions

EB 5171 EN

Firmware version 1.1x
Edition November 2005

Disclaimer of liability

We are constantly developing our products and therefore, reserve the right to change the product or the information contained in this document at any time without notice.

We do not assume any liability for the accuracy or completeness of these mounting and operating instructions. Moreover, we do not guarantee that the buyer can use the product for an intended purpose. SAMSON rejects any liability for claims by the buyer, especially claims for compensation including lost profits or any other financial loss, except the damage was caused intentionally or by gross negligence. If an essential term of the contract is breached by negligence, SAMSON's liability is limited to the foreseeable damage.

Safety instructions



- ▶ The device may only be assembled, started up or operated by trained and experienced personnel familiar with the product. Proper shipping and appropriate storage are assumed.
- ▶ The device has been designed for use in electrical power systems. For wiring and maintenance, you are required to observe the relevant safety regulations.

Contents

1	Operation	5
1.1	Operating elements	5
1.1.1	Operating keys	5
1.2	Display	6
1.3	Displaying data	7
1.4	Setting the controller time	8
1.5	Setting the times-of-use	9
2	Start-up	12
2.1	Programming	12
2.2	Activating and deactivating functions	13
2.3	Changing parameters	15
2.4	Entering the key number	16
2.5	Configuring the universal inputs	16
2.6	Resetting to default values	18
3	Manual operation	19
4	System-wide functions	20
4.1	Automatic summer time/winter time changeover	20
5	Operational faults	21
5.1	Error status register	21
5.2	Fault alarms	22
5.2.1	Sending SMS text message in case of a fault	22
5.2.2	Sending fax in case of a fault alarm	23
6	Communication	24
6.1	RS-232-C system bus interface	25
6.2	System bus interface with RS-232/RS-485 cable converters (for four-wire bus)	26
6.3	Description of communication parameters to be adjusted	27
6.4	Meter bus interface	29
6.4.1	Activating the meter bus	29
7	LON communication	31
7.1	Sending outdoor temperatures and the controller time	31
8	Installation	33
9	Electrical connection	35
10	Appendix	38
10.1	Function block list	38

10.2	Parameter list	40
10.3	Sensor resistance tables	44
10.4	Technical data	45
10.5	Customer data	47
	Index.	50
	Frequently used abbreviations.	54

1 Operation

The TROVIS 5171 Control and Processing Unit (**P**rogrammable Logic Controller = PLC) is freely programmable. The controller is delivered **without** an executable program in the memory. The application must be developed separately for the desired purpose on the PC using ISaGRAF® (programming as in DIN IEC 61131-1) and then transferred to the controller.

On start-up, after transferring the generated application, the **current time and date** must be set in the controller (-> section 1.4).

1.1 Operating elements

1.1.1 Operating keys

The keys are located in the front panel of the PLC and protected by a Plexiglas door.



Changeover key

(press with pen or other pointed item)
Switch between levels (-> inside of back cover)



Reset key

(press with pen or other pointed item)
Reset freely accessible parameters and function blocks to their default values (factory settings)



Cursor key(s)

- Navigate in levels (also in application developed with ISaGRAF®)
- Change values



Enter key

- Open levels (also in application developed with ISaGRAF®)
- Activate editing mode for parameters and function blocks
- Confirm entered settings

1.2 Display

After switching on and during operation, the PLC is in the operating level. When the application is active, either the name of the application or a customer-specific menu is displayed. This menu can be customized to meet your specific needs in the ISaGRAF® application. If no application has been loaded or activated, **STOP** is displayed. If an active connection between the PC and PLC exists, the  icon is displayed.

In the info level, the current controller time and operating data are displayed. The binary inputs and outputs are represented by black squares below the row of numbers. Icons indicate the operating status of the PLC.

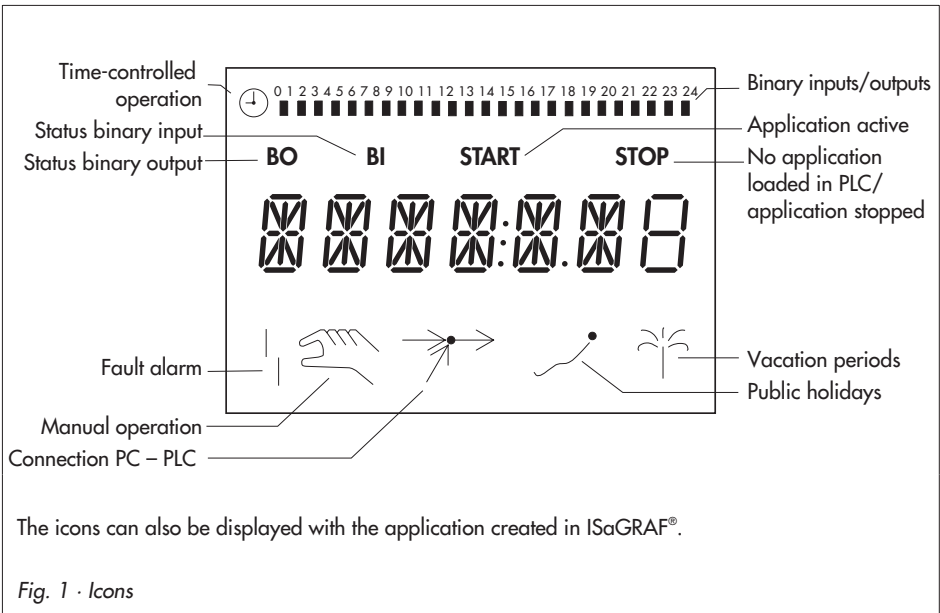

1.3 Displaying data

The states of the inputs and outputs, the available memory as well as information on fault alarms and communication can be retrieved in the info level.

The following levels provide information on the device status:

- ▶ FREI ___ KB: Free memory; for programming with ISaGRAF®
Bar graph indicates the cycle time:
Block 1 = 1 ms, Block 2 = 2 ms, Block 3 = 4 ms,
Block 4 = 8 ms, ...
- ▶ INF1 AI: Measured value of connected analog inputs (AE1 to AE17);
depending on configuration of universal inputs in CO6
[mA, °C, V]
BI: Status of the binary inputs (ON/OFF)
AO: Output value of the two analog outputs [V]
BO: Status of the binary outputs (ON/OFF)
- ▶ INF2...6 Do not exist
- ▶ INF7 LON communication
(in devices with LON interface and CO7 -> FB00 = ON)
- ▶ INF8 FSR: Error status register
BRUCH: Sensor failure information
- ▶ INF9 Modbus/meter bus communication

Proceed as follows:

⇒ **3s** Switch to configuration and parameter level.
Display shows: **PA5**

⏏ Select **END**.

⇒ Switch to info level.
Display shows: controller time

⏏ Select info level (-> Fig. 6 on page 53).

⊗ Open info level.

⏏ Select data point.

Exit info level:

⏏ Select **END**.

⊗ Return to operating level.
Display shows: name of the application or customer-specific menu

1.4 Setting the controller time

The current time and date need to be set immediately after start-up and after a power failure lasting more than 24 hours.

The time is set in **PA5** parameter level.

Proceed as follows:



- ⇒ **3s** Switch to configuration and parameter level.
Display shows: **PA5**



- ⊗ Open PA5 parameter level.
Display shows: controller time
- ⊗ Activate editing mode for controller time.
- ⏴ Change controller time.

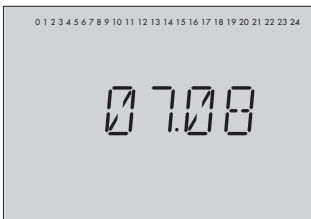

- ⊗ Confirm changed time.
Display shows: date (day.month)
- ⊗ Activate editing mode for date.
- ⏴ Change date.



- ⊗ Confirm date.
Display shows: year
- ⊗ Activate editing mode for year.
- ⏴ Change year.
- ⊗ Confirm year.
Display shows: **Zeit 1**

- ⏴ Select **END**.
- ⊗ Exit PA5 parameter level.
- ⏴ Select **END**.
- ⏴ Exit configuration and parameter level.
Display shows: controller time
- ⏴ Select **END**.
- ⊗ Switch to operating level.
Display shows: name of the application or customer-specific menu

Note!

If no key is pressed for two minutes, the PLC returns to operating level.

1.5 Setting the times-of-use

The controller provides 12 times-of-use that can be utilized separately.

Within a specified time-of-use (ZEIT 1 to ZEIT 12), two usage periods can be programmed for each day of the week. If you do not require all usage periods, the start and stop times of the idle periods must be set to identical times.

Note!

The behavior of the PLC during and outside the times-of-use is to be determined in the ISaGRAF® application.

Parameters	Default	Parameter level/Range of values
Period, day	Mo -- So	PA5 / Mo -- So, Monday to Sunday
Start time-of-use 1	7:00h	PA5 / 0:00h to 24:00h; in steps of 30 minutes
Stop time-of-use 1	12:00h	PA5 / 0:00h to 24:00h; in steps of 30 minutes
Start time-of-use 2	12:00h	PA5 / 0:00h to 24:00h; in steps of 30 minutes
Stop time-of-use 2	22:00h	PA5 / 0:00h to 24:00h; in steps of 30 minutes

Proceed as follows:

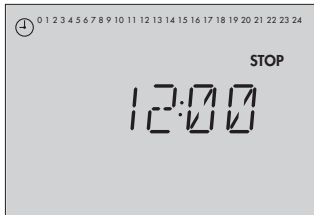
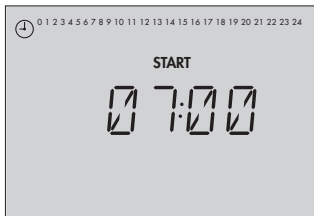
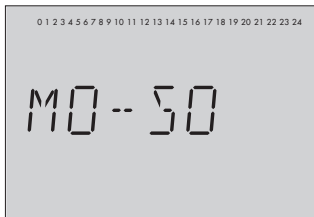

- ⌚ 3s Switch to configuration and parameter level.
Display shows: **PA5**
- ✖ Open PA5 parameter level.
Display shows: controller time
- ⏴ Select desired times-of-use (ZEIT 1 to ZEIT 12), e.g. ZEIT 1.
Display shows: **ZEIT _**

- ✖ Activate editing mode for selected time-of-use.
Display shows: **Mo -- So** (Monday to Sunday)

- ⏴ Select period/day for time-of-use.
- ✖ Activate editing mode for selected time-of-use.
Display shows: **START**; ⌚ blinks.
- ⏴ Edit start time (steps of 30 minutes).

- ✖ Confirm start time.
Display shows: **STOP**
- ⏴ Edit stop time (steps of 30 minutes).
- ✖ Confirm stop time.
Display shows: **START**
The second time-of-use is set similarly to the first.

To set times-of-use for each day, repeat the instructions in the fields highlighted in gray.

Note!

Do not use the Mo -- So menu to check the programmed times-of-use.

If this menu is opened after the times-of-use have been set, the usage times programmed for each day of the week are reset to their default settings.

-
- ⏴ Select **END**.
 - ⊗ Exit parameter level.
 - ⏴ Select **END**.
 - ⏴ Exit configuration and parameter level.
Display shows: controller time
 - ⏴ Select **END**.
 - ⊗ Switch to operating level.
Display shows: name of the application or customer-specific menu
-

Note!

If no key is pressed for two minutes, the PLC returns to the operating level.

2 Start-up

2.1 Programming

Programming the PLC requires a PC with ISaGRAF® software.

The ISaGRAF® software enables you to program a control system that is tailored to the specific needs of your plant (ISaGRAF® development environment 1400-7621). Programming must follow the structures and rules stipulated in DIN IEC 61131-3. The PLC may be programmed with the languages defined in the standard: Sequential Function Chart (SFC), Instruction List (IL), Flow Chart (FC), Function Block Diagram (FBD), Ladder Diagram (LD), and Structured Text (ST).

There are 128 KB of memory available in the PLC for the ISaGRAF® application.

The programmed application is compiled to machine code in the PC environment. This code is then transferred to the PLC over the front RJ-45 jack (connecting cable 1400-7308).

Programming languages:

Sequential Function Chart (SFC):	Used to describe operations of a sequential process with a simple graphic representation
Instruction List (IL):	Low-level textual language for logic and arithmetic operations
Flow Chart (FC):	High-level language used to visualize the data flow
Function Block Diagram (FBD):	Graphics-based language for building and combining complex functions (logical, arithmetic)
Ladder Diagram (LD):	Simple graphics-based language for logical operations (boolean)
Structured Text (ST):	High level language similar to PASCAL and C especially designed for control applications

For operation and application of the ISaGRAF® environment, refer to the documentation included in the software package. To enable simple and clear programming, ready-made functions and function blocks are available from SAMSON.

Note! In ISaGRAF®, internal variables can be assigned (hexadecimal) network addresses. The status or value of the internal variable is written to the associated holding register and can be read over Modbus. The PLC holding registers 42001 to 46999 are reserved for this purpose.

Important! The PLC application must be reloaded after a cold start.

2.2 Activating and deactivating functions

A function is activated over the associated function block. The numbers 0 to 24 in the top row of the display represent the respective function block numbers. When a configuration level is opened, the activated function blocks are indicated by a black square on the right-hand side below the function block number. For more details on function blocks, refer to section 10.1.

The functions are grouped by topics:

- ▶ CO1...4 Do not exist
- ▶ CO5 Higher level functions
- ▶ CO6 Configuration of universal inputs
- ▶ CO7 LON communication
(in devices with LON interface and CO7 -> FB00 = ON)
- ▶ CO8 Fault initialization
- ▶ CO9 Modbus/meter bus communication

Proceed as follows:

⇒ **3s** Switch to configuration and parameter level.
Display shows: **PA5**

⏴ Select configuration level (→ Fig. 6 on page 53).

⊗ Open configuration level.

⏴ Select function block.

⊗ Activate editing mode for selected function block.
Function block number blinks.

When the display shows **0 0 0 0**, the valid key number must be entered, see section 2.4.

⏴ Activate function block (FB = ON).

An activated function block is indicated by a black square on the right-hand side below the function block number.

Or:

⏴ Deactivate function block (FB = OFF).

⊗ Confirm changed settings.

If the function block is not closed, further function blocks can be edited.

Proceed as follows:

Change settings and confirm changes.

If applicable, the following function block parameter is displayed.

Once all parameters have been confirmed, the opened function block is closed.

To set further function blocks, repeat the instructions in the fields highlighted in gray.

- ⏴ Select **END**.
 - ⊗ Exit configuration level.
 - ⏴ Select **END**.
 - ⏴ Exit configuration and parameter level.
Display shows: controller time
 - ⏴ Select **END**.
 - ⊗ Switch to operating level.
Display shows: name of the application or customer-specific menu
-

Note!

If no key is pressed for two minutes, the PLC returns to the operating level.

2.3 Changing parameters

Depending on the activated functions, not all parameters listed in the Appendix (→ section 10.2) might be available.

The parameters are grouped by topics:

- ▶ PA1...4 Do not exist
- ▶ PA5 Controller time, times-of-use
- ▶ PA6 Does not exist
- ▶ PA7 LON communication
(in devices with LON interface and CO7 → FB00 = ON)
- ▶ PA8 Does not exist
- ▶ PA9 Modbus/meter bus communication

Proceed as follows:

⇒ **3s** Switch to configuration and parameter level. Display shows: **PA5**

⏴ Select parameter level (→ Fig. 6 on page 53).

⊗ Open parameter level.

⏴ Select parameter.

⊗ Activate editing mode for selected parameter.

⏴ Change parameter.

⊗ Confirm parameter.

To set further parameters, repeat the instructions in the fields highlighted in gray.

⏴ Select **END**.

⊗ Exit parameter level.

⏴ Select **END**.

⇒ Exit configuration and parameter level.
Display shows: controller time

⏴ Select **END**.

⊗ Switch to operating level.
Display shows: name of the application or customer-specific menu

Note!

If no key is pressed for two minutes, the PLC returns to operating level.

2.4 Entering the key number

Some functions are protected against unintentional and unauthorized access by a key number. The key number, which is required to activate and deactivate protected functions, can be found on page 49. To avoid unauthorized use, remove the page or make the key number unreadable.

Proceed as follows:

On the display, **0 0 0 0** blinks.

- ⏴ Enter key number.
- ⊗ Confirm key number.
When the correct number has been entered, the function block you wish to change blinks on the display.
When an invalid key number is entered, the PLC switches to the next configuration level.

The key number remains active for approximately 5 minutes.

2.5 Configuring the universal inputs

Note!

Connect a 50 Ω resistor in parallel on using the 0(4) to 20 mA input.
When the inputs (0 to 10 V or 0(4) to 20 mA) are active, use terminal 13 for GND instead of terminal 10.

17 universal inputs are available. The inputs can be configured to serve as a binary, analog (0 to 10 V, 0(4) to 20 mA) or sensor input. The hardware must be configured accordingly (sensor initialization).

The sensor resistance values can be found on page 44.

The following applies:

- ▶ CO6 -> Fb00 = ON: Pt 100 and Pt 1000 mixed (default)
- ▶ CO6 -> Fb00 = OFF: Pt 100 and PTC mixed

Each universal input can also be configured separately.

The following function block parameters are available: Pt 100/500/1000/2000, Ni 200/1000/2000, PTC, NTC, OHM (1-2 kΩ), BE, 0(4) to 20 mA, and 0 to 10 V (model no. 5171-0003 and higher).

The function blocks FB01 to FB17 correspond to the binary inputs BE1 to BE17 in the wiring

diagram (-> page 37). The function block for the selected sensor is activated and the function block parameter associated with the type of input signal is selected.

If the temperature values displayed by the PLC deviate from the actual temperatures, the measured values of the connected sensors can be changed or reset.

When calibrating a sensor, the currently displayed sensor value must be changed such that it corresponds to the temperature value (reference value) measured directly at the point of measurement.

Sensor calibration must be activated in CO6 using FB23.

An improper calibration can be deleted by setting FB23 = OFF.

Note!

The tolerance by which a sensor value can be corrected is ± 12 °C.

Proceed as follows:

⇒ **3s** Switch to configuration and parameter level.

Display shows: **PA5**

- ⏴ Select CO6 configuration level.
- ⊗ Open CO6 configuration level.
- ⏴ Select function block FB23.
- ⊗ Open function block FB23.
- ⏴ Select sensor input you wish to calibrate.
- ⊗ Display measured value. Measured value blinks.
- ⏴ Correct measured value.
Use the actual temperature from a thermometer installed directly at the point of measurement as reference value.
- ⊗ Confirm corrected measured value.

Further sensors are calibrated similarly.

- ⏴ Select **END**.
- ⊗ Exit configuration level.
- ⏴ Select **END**.
- ⇒ Exit configuration and parameter level. Display shows: controller time
- ⏴ Select **END**.

- ⊠ Switch to operating level.
Display shows: name of the application or customer-specific menu

2.6 Resetting to default values

All parameters and function blocks that were set without previously entering the key number can be reset to their default values (factory settings) from configuration and parameter level.

Important!

Certain functions may no longer be available depending on the ISaGRAF® application once the parameters and function blocks were reset to their default values.

Proceed as follows:

- ⇒ **3s** Switch to configuration and parameter level.
Display shows: **PA5**
 - * Load default settings.
Parameters are reset to their default values.
-

Note!

Function blocks that are protected by the key number will only be reset if the key number is still active.

3 Manual operation

All outputs are configured in manual operating mode (see wiring diagram in section 9).

Proceed as follows:

⇒ **3s** Switch to configuration and parameter level.
Display shows: **PA5**

↓ Select **END**.

⇒ Switch to info level.
Display shows: controller time

↓ Select **Hand**.

⊗ Open manual level.

↓ Select output:
A01 = analog output 1 (0 to 10 V)
A02 = analog output 2 (0 to 10 V)
B01 = binary output 1
B02 = binary output 2

⊗ Activate editing mode for selected output.
Display blinks.

↑ Activate output, increase value.

Or:

↓ Deactivate output, reduce value.

⊗ Confirm changes.
The changed values remain valid as long as manual operating mode is active.

↓ Select **END**.

⊗ Exit manual level.

↓ Select **END**.

⊗ Switch to operating level.
Display shows: name of the application or customer-specific menu

4 System-wide functions

4.1 Automatic summer time/winter time changeover

The time is automatically adapted on the last Sunday in March at 2.00h and on the last Sunday in October at 3.00h.

Function	WE	Configuration
Summer time/winter time changeover	ON	CO5 -> F05 = ON

5 Operational faults

If the corresponding universal inputs are configured as sensors using CO6 -> FB01 to FB17 = ON, a sensor failure can be detected, processed, and indicated (text message, fax).

5.1 Error status register

In the INF8 level, the bits of the error status register are indicated.

The error status register (holding register - 16 bit) HR 60 serves as indicator for faults of the controller or the plant. In modem mode (CO9 -> FB01 = ON), a change in status of HR 60 triggers a dial-up connection to the building control station.

Note!

Error status register HR 61 is displayed in the PLC but not used for fault indication.

Holding register HR 60

Number = bit number in the HR

If bit is set, is displayed to the right below the number.

Bit value

Sensor failure

Reset to default values

–

–

–

–

Unauthorized access occurred

Fault alarm of a binary input

Fault of heat meter on M-Bus

Fault indicated by heat meter

–

Fault alarm binary input changed

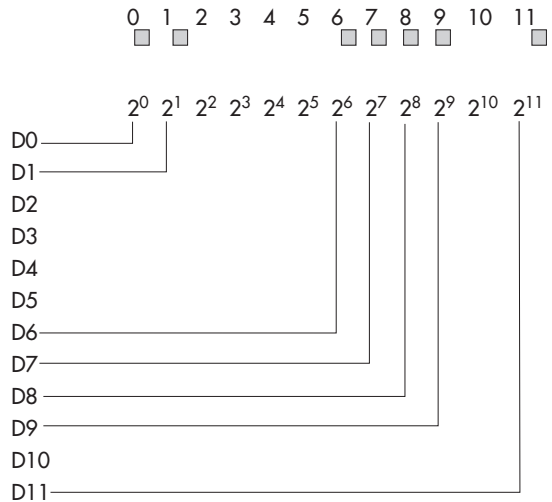

Example of transfer to the process control system:

The error status register is transferred as a word <w> in a holding register whose content is represented by the sum of the respective number <n> of the active data bit:

$$\langle w \rangle = ([D0] \times \langle 1 \rangle + ([D11] \times \langle 2048 \rangle)$$

5.2 Fault alarms

Fault alarms can be forwarded either directly to the process control station over a modem, to a mobile phone over the SMS function or to a fax machine. Only one function (Modbus, SMS or fax function) can be selected at a time as the functions use the same interface.

Fault alarms forwarded to a mobile phone or fax contain the number of the affected error status register (FSR1), the fault as specified in the error status register (BitNo), the short designation of the device, and the bit number (Bit xx).

5.2.1 Sending SMS text message in case of a fault

Currently, fault alarms can only be forwarded to mobile phones in the German D1 network. The appropriate D1 network access number as well as the recipient's mobile phone number must be entered in PA9 parameter level:

- ▶ **D1 network access number:** 0171 252 10 02
(place an additional 0 in front when dialing from a private branch exchange)
Numbers 0 to 9, P = pause, - = end, max. 22 characters
The network access number is issued by the network operator Deutsche Telekom and may change without notice.
- ▶ **Recipient's mobile number:** 49 xxx yyyyyyy where
xxx stands for 171, 160 or any other valid D1 dialing code and
yyyyyyy represents the recipient's phone number
Numbers 0 to 9, P = pause, - = end, max. 14 characters

Note!

At the moment, SMS fault alarms cannot be sent to any other mobile phone network than D1.

Functions	Default	Configuration
Modbus	ON	CO9 -> FB00 = OFF
Modem	OFF	CO9 -> FB01 = OFF
SMS fault alarm	OFF	CO9 -> FB06 = ON
SMS dialing mode	OFF	CO9 -> FB07
Fax fault alarm	OFF	CO9 -> FB10 = OFF

Parameters	Default	Parameter level/Range of values
Access number (ZUGNO)	–	PA9 / Freely configurable*
Recipient's mobile phone no. (HANDY)	–	PA9 / Freely configurable**
* Numbers 0 to 9, P = pause, - = end, max. 22 characters		
** Numbers 0 to 9, P = pause, - = end, max. 14 characters		

5.2.2 Sending fax in case of a fault alarm

The device type is forwarded in addition to a detailed error description. The recipient's fax number must be programmed in the PA9 level. Optionally, also the sender's station ID can be programmed; this number will then be forwarded as well. If no station ID is specified, the string "nicht verfügbar" (not available) is inserted.

- ▶ **Fax number:** numbers 0 to 9, P = pause, - = end, max. 14 characters
(place an additional 0 in front when dialing from a private branch exchange)
- ▶ **Station ID:** numbers 0 to 9, P = pause, - = end, max. 14 characters

Functions	Default	Configuration
Modbus	ON	CO9 -> FB00 = OFF
Modem	OFF	CO9 -> FB01 = OFF
SMS fault alarm	OFF	CO9 -> FB06 = OFF
Fax fault alarm	OFF	CO9 -> FB10 = ON
Fax dialing mode	OFF	CO9 -> FB11
Parameters	Default	Parameter level/value range
Fax number (TELNO)	–	PA9 / Freely configurable*
Station ID (ST ID)	–	PA9 / Freely configurable*
* Numbers 0 to 9, P = pause, - = end, max. 14 characters		

6 Communication

Using the serial system bus interface, the PLC can communicate with a building control station. Together with the suitable process visualization software and communication software, a complete control system can be implemented.

The following interface settings are possible:

– **Operation with a dial-up modem on the RS-232-C system bus interface**

Basically, communication is only established automatically when faults occur in the plant. The controller works autonomously. Nevertheless, the modem can dial up to the controller at any time to read data from it or change settings, if necessary. The use of the modem connecting cable (1400-7139) is recommended.

– **Operation with a leased line modem on the RS-232-C system bus interface**

Communication is established over a permanent connection between two leased line modems. This setup is applied for long-distance transmissions or when different signal level converters are used. The connection cable between the device and the modem can also be established over the modem connecting cable (1400-7139).

- **Operation on a four-wire bus**

To link the controller and the bus line, the signal level needs to be converted by an appropriate converter (SAMSON cable converter 1400-7308).

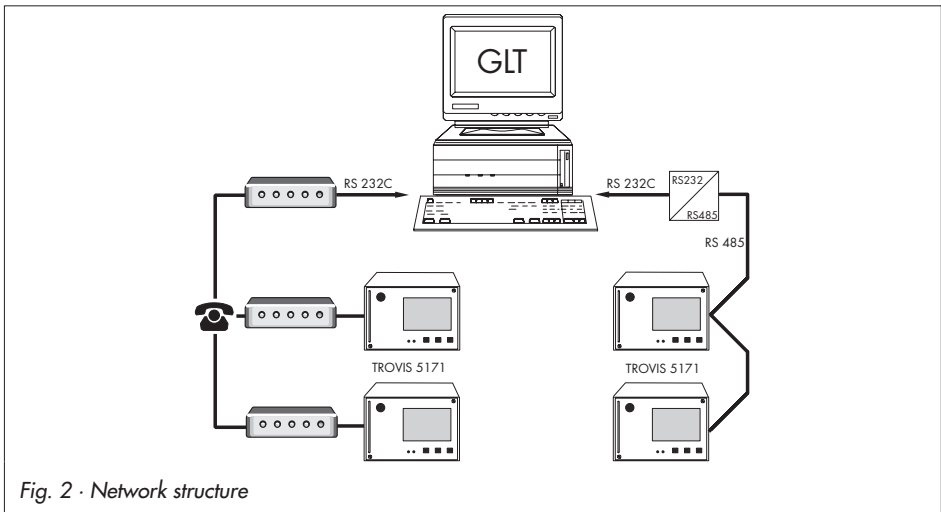

Fig. 2 · Network structure

The PLC is equipped with an RS-232 Modbus interface. Optionally, a cable converter (1400-7308) for operation on a four-wire bus is available.

6.1 RS-232-C system bus interface

The system bus connection is located on the rear panel of the controller housing (RJ 12 connector). The device can be connected either directly to the serial interface of a PC (point-to-point connection) or to a (dial-up) modem. A dial-up modem is required if the controller is to be connected to the telecommunications network. In this case, the controller operates autonomously and issues an alarm to the building control station (GLT) when faults occur. In addition, the building control station can dial up to the controller, read data from it, and transfer new data to it after the valid key number has been written to holding register 40070.

If the key number was accepted by the controller, register value "1" indicates write permission. Otherwise, the register value remains "0". Write permission must be obtained upon each connection by sending the key number.

Note!

If an invalid key number is written to holding register 40070 for the third consecutive time, the controller immediately interrupts the modem connection and activates bit D6 in the error status register (Unauthorized access occurred). As a result, an alarm call is triggered to the configured control system or an SMS text message/fax is sent. Bit D6 is reset as soon as the error status register was read by the control system and the connection was terminated.

In special cases, the **Lock dial-up** function can be selected to stop dial-up in case of faults. Using the **Dial-up also upon corrected fault** function, the controller additionally informs the building control station when a previously signaled fault no longer persists.

Functions	Default	Configuration
Modem	ON	CO9 -> FB01 = ON
Modem dialing mode	OFF	CO9 -> FB02
Lock dial-up	OFF	CO9 -> FB03
Dial-up also upon corrected fault	OFF	CO8 -> FB00
Parameters*	Default	Parameter level/Range of values
Station address	255	PA9 / 1 to 247 (1 to 999 with CO9 -> FB04 = ON)
Baud rate	9600	PA9 / 300 to 19200
Cyclical initialization (I)	30 min	PA9 / 0 to 255 min
Modem dialing pause (P)	5 min	PA9 / 1 to 255 min
Modem time-out (T)	5 min	PA9 / 0 to 255 min

Parameters*	Default	Parameter level/Range of values
No. of redialing attempts (C)	5	PA9 / 0 to 99
Phone no. of control station (TELNO)	-	PA9 / Freely configurable**
Alternative phone no. (RESNO)	-	PA9 / Freely configurable**

** Numbers 0 to 9, P = pause, - = end, max. 22 characters

* -> Section 6.3 (Description of communication parameters to be adjusted)

6.2 System bus interface with RS-232/RS-485 cable converters (for four-wire bus)

Operating the PLC in combination with cable converters requires a permanent bus connection (data cable). The bus line links the devices/control units in an open ring. At the end of the bus line, the data cable is connected to the control station using an RS-485/RS-232 converter (e.g. TROVIS 5484). The maximum extension (cable length) of the bus line is 1,200 m. A maximum of 32 devices can be connected to such a segment. If you wish to use more than 32 devices or need to bridge greater distances, make sure repeaters (e.g. TROVIS 5482) are installed to replicate the signal. In all, a maximum of 246 devices can be connected to a bus line.

Caution!

Make sure that the relevant standards and regulations concerning lightning and overvoltage protection are observed upon installation.

Functions	Default	Configuration
Modbus	ON	CO9 -> FB00 = ON
Modem	OFF	CO9 -> FB01 = OFF
Modbus 16-bit addressing	OFF	CO9 -> FB04

Parameters*	Default	Parameter level/value range
Station address	255	PA9 / 1 to 247 (1 to 999 with CO9 -> FB04 = ON)
Baud rate	9600	PA9 / 300 to 19200

* -> Section 6.3 (Description of communication parameters to be adjusted)

6.3 Description of communication parameters to be adjusted

Station address

This address is used to identify the PLC in bus or modem operation. In a system, each controller needs to be assigned a unique address.

Baud rate

In a bus system, baud rate refers to the transfer speed between the control system and the PLC. In modem mode, the parameter refers to the transfer speed between controller and modem.

The baud rate adjusted on the PLC must correspond to the baud rate of the control system, otherwise no communication can be established.

Cyclical initialization (I)

This parameter defines the period of time for a cyclical issue of the initialization command "ATZ". The command is not issued during dial-up or when connected. "ATZ" causes the configuration profile 0 to be copied to the active profile, provided the modem parameters have been set and saved in profile 0 using a suitable terminal program.

Sample initialization of a modem with a terminal program:

AT & F (restores modem to its factory settings)
 OK (response of the modem)
 ATEOSO = 1 (EO: echo off;
 SO = 1: answer on first ring)

Modem dialing pause (P)

It is recommended to observe an interval of approx. 3 to 5 minutes between dialing up to the control system, text messaging center or fax machine to avoid a permanent overloading of the (telecommunications) network. The modem dialing pause is the interval between two dialing attempts.

Modem time-out (T)

When the controller connects to the building control station but without addressing a Modbus data point, the PLC closes the connection after the time specified for *Modem time-out* has elapsed. If the error status register was not read during this connection, the PLC dials up to the GLT again after the *Modem dialing pause (P)* has elapsed.

No. of redialing attempts (C)

The controller tries to dial up to the control system again, observing the *Modem dialing pause*, in case the GLT, text messaging center or the fax machine is busy or the function that triggered the alarm call has not been reset by the control system. After the specified number of redialing attempts has failed, the PLC switches to the *Alternative phone no.* Resetting a triggered call = reading the error status register (HR 40060)

Phone no. of control station (TELNO)

Enter the phone number of the control system’s modem, if required including the dialing code. Short pauses between the numbers can be entered using P (= 1 second); “-” indicates the end of the string. The phone number can include max. 22 characters.

Example: “069, 2 sec. pause, 4009, 1 sec. pause, 0”:

0 6 9 P P 4 0 0 9 P 0 - (= 11 characters)

Alternative phone no. (RESNO)

Enter the phone number of an alternative recipient, if required including the dialing code. Short pauses between the numbers can be entered using P (= 1 second); “-” indicates the end of the string. The phone number can include max. 22 characters.

Example: “069, 1 sec. pause, 654321”:

0 6 9 P 6 5 4 3 2 1 - (= 10 characters)

Common modem settings are:

- ▶ EO - Echo off
- ▶ QO - Enable result codes
- ▶ X3 - Dial without checking for dial tone
- ▶ % CO - Data compression off
- ▶ \ N1 - Buffer off, fault correction off
- ▶ V1 - Result codes in text format
- ▶ % B 9600 - Baud rate 9600
- ▶ \ VO - Standard connect result codes

Resetting to default settings

A modem can be reset to its default settings directly at the PLC using the key number.

Key number	Command
44	AT&F&W <CR> <LF>
45	AT&F&W ATX3 <CR> <LF> (for branch exchange systems)

Note!

The initialization settings described here are indispensable for operation on a dial-up modem. Nevertheless, it cannot be guaranteed that data are transferred after the initialization settings have been adjusted. Due to the broad range of modems available on the market and the different commands, refer to the operating manual of the modem for further details.

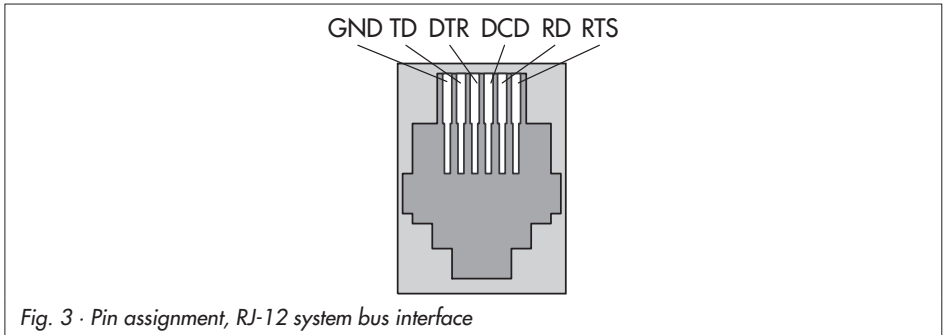

Fig. 3 · Pin assignment, RJ-12 system bus interface

6.4 Meter bus interface

Thanks to the meter bus interface, the PLC can communicate with up to 3 heat and water meters according to EN 1434-3.

Details on the use of the different heat and water meters can be found in the technical documentation TV-SK 6311.

6.4.1 Activating the meter bus

To successfully transfer data from the heat meter (WMZ) to the PLC, the heat meter must use a standardized protocol in accordance with EN 1434-3. It is impossible to make a general statement about which specific data can be accessed in each meter. For details on the different meter makes, refer to the technical documentation TV-SK 6311. All necessary function block parameters to set up communication with heat or water meters are available in CO9 -> FB21 to FB23. The meter bus address, the model code, and the reading mode must be specified. A meter bus address must be unique and correspond with the address preset in the WMZ.

If the preset meter bus address is unknown, a single heat meter connected to the controller can be assigned meter bus address 254. Address 255 deactivates communication with the respective heat meter. The model code, which needs to be set for the respective heat meter, can be found in TV-SK 6311. In general, the default setting of 1434 can be used for most devices.

The meters can be read either automatically approx. every 24 hours (24h), continuously (con) or when the coils (= Modbus data points) assigned to the heat meters WMZ1 to WMZ3 are overwritten with the value 1 over the system bus interface (Coil).

In INF9 info level, "1434" is displayed when the meter bus is activated. Press the enter key to get to the display referring to the meter bus. For each of the three heat meters whose address is not 255, "buSi" (with i = 1, 2, 3) is indicated. Press the enter key again to display the following information about the associated meter:

- ▶ Flow rate (d, cm/h)
- ▶ Total capacity (U, cm³)
- ▶ Capacity (P, kW)
- ▶ Energy (A, Mwh, GJ)
- ▶ Flow temperature (b, °C)
- ▶ Return flow temperature (b, °C)
- ▶ Meter identification number (L without enter key, H with enter key)
- ▶ Meter bus address (sent by WMZ) (A, -)

Blinking values in combination with black squares in the top row of the display (fault status of the associated meter → TV-SK 6311) indicate different faults.

Note!

With reading mode "24h", the displayed values are not updated by reading the status information again; the values read during the last cycle remain unchanged.

With reading mode "con", the values in the levels are not continuously updated. Reopen the specific level to get current values.

Functions	Default	Configuration
Meter bus 1, 2, 3	OFF	CO9 → FB21 = ON, FB22 = ON, FB23 = ON
	255	Meter bus address for WMZ 1, 2, 3 / 0 to 255
	1434	Model code WMZ 1, 2, 3 / P15, PS2, 1434, CAL3, APAIO, SLS
	con	Reading mode WMZ 1, 2, 3 / 24h, con, CoIL

7 LON communication

Note!

The following section only applies to devices with LON interface and CO7 -> FB00 = ON. On connecting LONMARK devices, CO7 -> FB00 = OFF needs to be configured.

Using LON, the inputs and outputs of max. 20 Series 5100 Controllers can be read. The connected controllers transmit their inputs and outputs as well as the pulse counter and its pulse length to the PLC over LON.

Each controller is assigned a LON station address, which needs to be set in parameter level PA7. A station address in a subnet must be unique. Each controller type is assigned its own subnet. This means that identical LON station addresses can be assigned for different controller types, e.g. 5174 and 5179, as they belong to different subnets.

Controller type	Subnet	Station address
TROVIS 5171	1	1 to 20
TROVIS 5174	4	1 to 20
TROVIS 5177	7	1 to 20
TROVIS 5179	9	1 to 20

Moreover, a master PLC can control the binary outputs of four additional TROVIS 5171 Controllers (-> max. 60 binary outputs). The address of the master PLC is set in parameter level PA7 (value range: 1 to 20); it must be different from the addresses of the additional controllers.

Functions	Default	Configuration
LON active	OFF	CO7 -> FB00 = ON

In INF7 info level, all other TROVIS 5100 devices are listed with their controller type and LON address (e.g. "74-01"). If the display blinks, a fault occurred during communication.

7.1 Sending outdoor temperatures and the controller time

Two outdoor temperatures and the controller time can be made available on the LON bus to be adopted by the other controllers. Each controller in the system can send these values. The values are either sent by one controller or each values is transmitted by a separate controller.

The controller time and the outdoor temperature are transmitted every four minutes. In addition, the outdoor temperature is sent when it changed by 0.5 °C or more. All controllers delete the values received over the bus ten minutes after the last update.

Transmitting the controller time

The controller time can be made available to all LON devices. They read the transmitted controller time and adopt it. The controller time is sent using CO7 -> FB02 = ON. This function may only be activated in one LON device; otherwise, different controller times may be transmitted.

In case the LON device sending the controller time fails, all other devices continue operation with their local time setting.

Functions	Default	Configuration
Controller time	OFF	CO7 -> FB02

Transmitting the outdoor temperatures

Two outdoor temperatures can be made available on the bus. Activate the associated function block and specify the terminal number of the sensor whose value is to be sent. The transmitted temperature values are available to all LON devices.

Functions	Default	Configuration
Outdoor temperature 1	OFF	CO7 -> FB03 Terminal number
Outdoor temperature 2	OFF	CO7 -> FB04 Terminal number

Note!

The outdoor temperature used by each LON device is configured on selecting the outdoor sensor (select: FUEHL, 0-10; Lon1, Lon-2).

8 Installation

The controller consists of the housing with the electronics and the back panel with the terminals. It is suitable for panel, wall, and top hat rail mounting (Fig. 4).

Panel mounting

1. Remove both screws (1).
2. Pull apart the controller housing and back panel.
3. Make a cut-out of 138 x 92 mm (width x height) in the control panel.
4. Insert the controller housing through the panel cut-out.
5. Insert one mounting clamp (2) each at the top and bottom or at the sides. Screw the threaded rod towards the panel with a screwdriver such that the housing is clamped against the control panel.
6. Install the electrical connections at the back of the housing as described in section 9.
7. Fit the controller housing.
8. Fasten both screws (1).

Wall mounting

1. Remove both screws (1).
2. Pull apart the controller housing and back panel.
3. If necessary, bore holes with the specified dimensions in the appropriate places. Fasten the back panel with four screws.
4. Install the electrical connections at the back of the housing as described in section 9.
5. Fit the controller housing.
6. Fasten both screws (1).

Top hat rail mounting

1. Fasten the spring-loaded hook (4) at the bottom of the top hat rail (3).
2. Slightly push the controller upwards and pull the upper hooks (5) over the top hat rail.

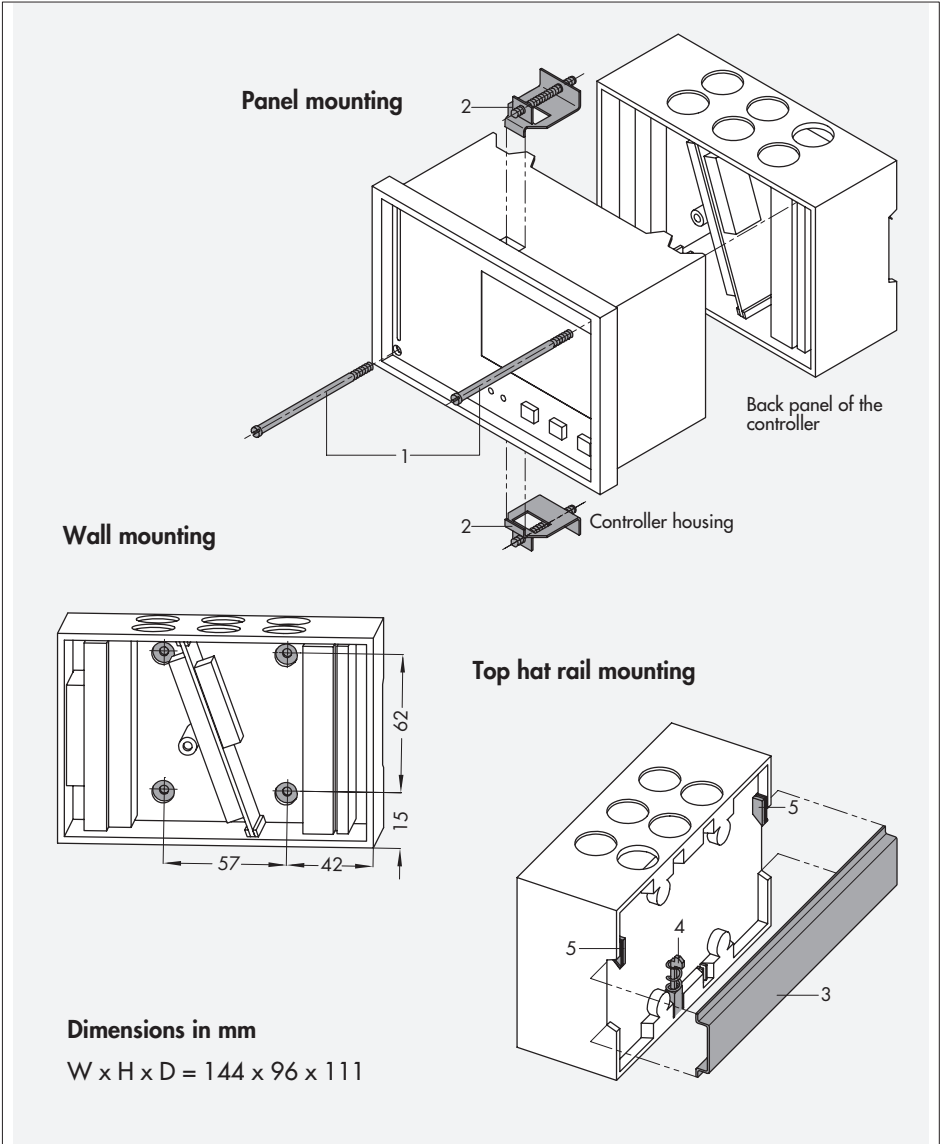

Fig. 4 Installation

9 Electrical connection

Caution!

For electrical connection of the PLC, you are required to observe the relevant electrotechnical regulations of the country of use as well as the regulations of the local power supplier. Make sure all electrical connections are installed by trained and qualified personnel!

Notes on installing the electrical connections

- ▶ Install the 230 V power supply lines and the signal lines separately! To increase noise immunity, observe a minimum distance of 10 cm between the lines. Make sure the minimum distance is also observed when the lines are installed in a cabinet.
- ▶ The lines for digital signals (bus lines) and analog signals (sensor lines, analog outputs) must also be installed separately.
- ▶ In plants with a high electromagnetic noise level, we recommend to use shielded cables for the analog signal lines. Ground the shield at one side, either at the control cabinet inlet or outlet, using the largest possible cross-section. Connect the central grounding point and the PE grounding conductor with a cable $\geq 10 \text{ mm}^2$ using the shortest route.
- ▶ Inductances in the control cabinet, e.g. contactor coils, are to be equipped with suitable interference suppressors (RC elements).
- ▶ Control cabinet elements with high field strength, e.g. transformers or frequency converters, should be shielded with separators providing a good ground connection.

Overvoltage protection

- ▶ If signal lines are installed outside buildings or over large distances, make sure appropriate surge or overvoltage protection measures are taken. Such measures are indispensable for bus lines!
- ▶ The shield of signal lines installed outside buildings must have current conducting capacity and be grounded on both sides.
- ▶ Surge diverters must be installed at the control cabinet inlet.

Noise suppression

The TROVIS 5171 Controller with SAMSON actuator is interference suppressed according to VDE 0875. If different actuator makes are used, or moreover, further actuators with interference sources are used in a plant, the operator/supplier of a custom-made plant must make sure that the entire plant complies with VDE 0875 regulations due to the legal obligation of ensuring interference suppression.

Connecting the PLC

Open the housing to connect the cables. Make holes in the marked locations at the top, bottom or back of the housing's back panel and fit suitable grommets or screw joints.

Observe the diagram on the following page for connection. The connection diagram contains all possible inputs and outputs. The assignment of the corresponding inputs and outputs is determined by the respective program.

Inputs

When wiring the universal inputs (BE1/AE1 to BE17/AE17), make sure to use terminal 13 as ground in case of active inputs (current and voltage inputs). If the universal inputs are used as passive inputs (sensors or binary inputs), terminal 10 must be used as ground.

Outputs

The binary low-voltage outputs (BA1 and BA2) are used for signaling. As a result, only a minimal load can be applied to these outputs (50 V DC, max. 100 mA ohmic load). If greater loads are to be applied, it is recommended to control relays over the outputs which then switch the elevated load.

The 10 binary outputs (BA3 to BA12) can be loaded with max. 250 V AC, 2 A.

LON network (SAMSON's own LON)

In devices with LON interface, the LON bus can be connected to terminals 1 and 2. The wiring has a reverse polarity protection, i.e. the two strands can be assigned to the terminals as you like.

LONMARK

The connection of LONMARK devices requires additional software.

The devices are connected to terminals 1 and 2.

On using LONMARK devices, the SAMSON LON is not available. In this case, CO7 -> FB00 = OFF must be configured.

Meter bus

The meter bus is connected to terminals 48, 49, and 50.

Terminal 48:	Input signal
Terminal 49:	Neutral conductor
Terminal 50:	Voltage supply for heat meter, 15 V DC (if required)

Modbus

The Modbus is connected over the RS-232 serial interface.

Connecting the sensors

Cables with a minimum cross-section of $2 \times 0.5 \text{ mm}^2$ can be connected to the terminals at the back panel of the housing.

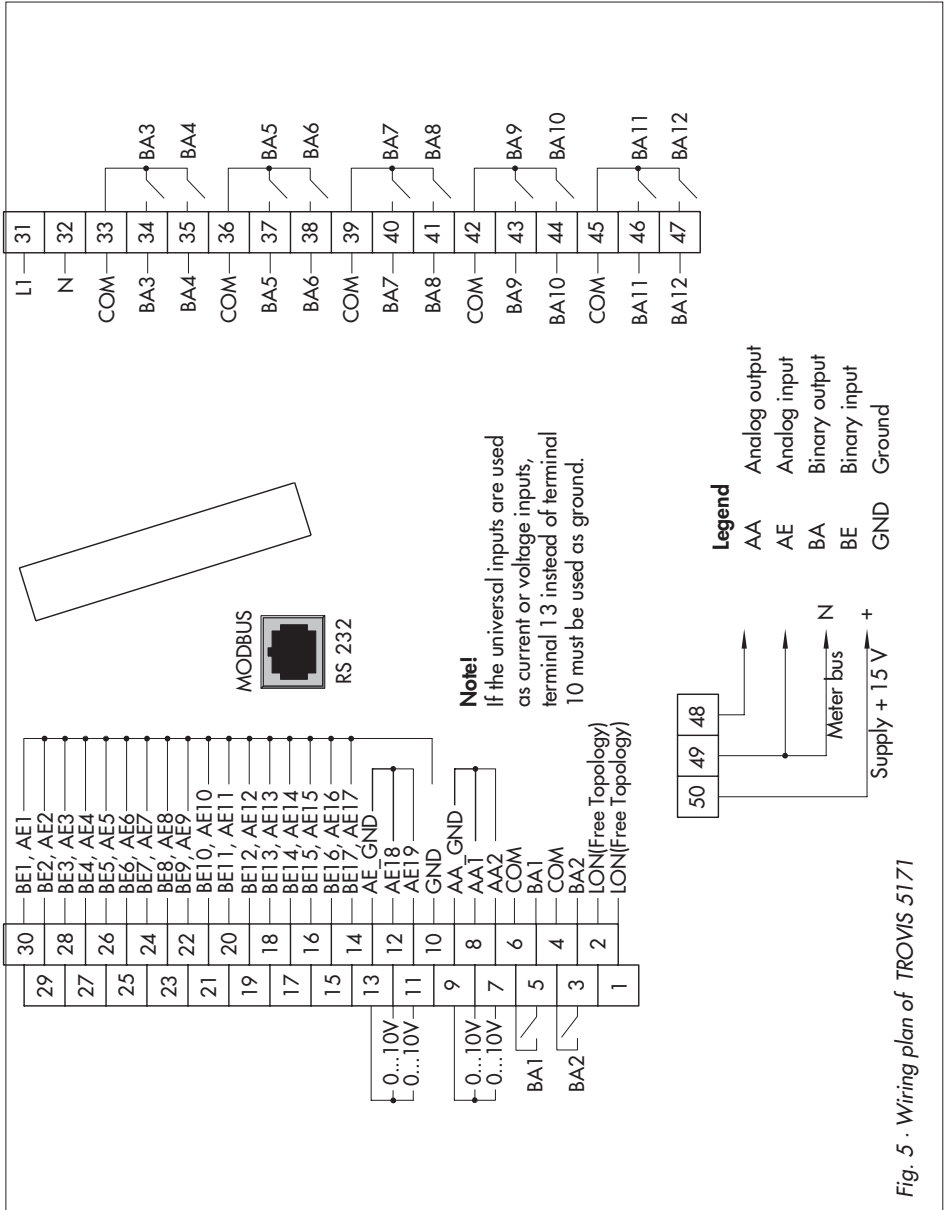

Fig. 5 - Wiring plan of TROVIS 5171

10 Appendix

10.1 Function block list

CO5: General functions

5	Summer time/winter time changeover	ON	CO5 -> FB05 = ON: Automatic summer time/winter time changeover active
---	------------------------------------	----	---

CO6: Configuring the universal inputs

FB	Function	WE	Comment
00	Sensor configuration, global	ON	CO6 -> FB00 = ON: Pt100 and/or Pt1000 CO6 -> FB00 = OFF: Pt100 and/or PTC
01 to 17	Universal input 1 to Universal input 17, deviating from FB00	OFF	CO6 -> FB01 to FB17: Select: Pt 100/500/1000/2000, Ni 200/1000/2000, PTC, NTC, OHM (1-2 k Ω), BE, 0-20 mA, 4-20 mA, 0-10 V (model no. 5171-0003 and higher)
23	Sensor calibration	OFF	CO6 -> FB23 = ON: Sensor calibration in FB01 to FB17

FB Function block, WE Default settings

CO7: LON communication (FB01, FB02, ... only with CO7 -> FB00 = ON)

FB	Function	WE	Comment
00	LON active	OFF	CO7 -> FB00 = ON: LON interface active
01	-	-	For internal purposes only
02	Controller time	OFF	CO7 -> FB02 = ON: Controller time of the PLC = controller time of all LON devices
03	Outdoor temperature 1	OFF	CO7 -> FB03 = ON: LON outdoor temperature 1 is transmitted, Select: terminal numbers
04	Outdoor temperature 2	OFF	CO7 -> FB04 = ON: LON outdoor temperature 2 is transmitted, Select: terminal numbers
05	Report fault of other LON device	OFF	CO7 -> FB05 = ON: Alarm in case a fault occurred in an other LON device

FB Function block, WE Default settings

CO8: Fault initialization (changes require the key number)

FB	Function	WE	Comment
00	Dial-up also upon corrected fault	OFF	CO8 -> FB00 = ON: Dial-up to the building control station both when a fault was detected and a fault was corrected CO8 -> FB00 = OFF: Dial-up to building control station only when fault was detected
01 to 17	BE1 to BE17 sent to FSR	OFF	CO8 -> FB01 to FB17 = ON: Select : "Rising signal edge/make contact", "Negative signal edge/break contact"
22	Limit monitoring	OFF	Can be configured over Modbus
23	Fault alarm binary input changed	OFF	CO8 -> FB23 = ON: Subsequent faults are also registered in error status register (Bit D11)

FB Function block, WE Default settings

CO9: Modbus and meter bus communication



FB	Function	WE	Comment Function block parameter / Range of values (default settings)
00	Modbus	ON	CO9 -> FB00 = ON: Modbus active
01	Modem	OFF	CO9 -> FB01 = ON: Modem active
02	Modem dialing mode	OFF	CO9 -> FB02 = ON: Pulse dialing CO9 -> FB02 = OFF: Tone dialing
03	Lock dial-up	OFF	CO9 -> FB03 = ON: No dial-up in case of fault
04	Modbus 16-bit addressing	OFF	CO9 -> FB04 = ON: 16-bit addressing CO9 -> FB04 = OFF: 8-bit addressing
05	Manual assignment of Modbus addresses	OFF	CO9 -> FB05 = ON: Modbus addressing acc. to datapoint list CO9 -> FB05 = OFF: Modbus addressing using ISaGRAF®
06	SMS fault alarm	OFF	CO9 -> FB06 = ON: Fault alarm to a mobile phone
07	SMS dialing mode	OFF	CO9 -> FB07 = ON: Pulse dialing CO9 -> FB07 = OFF: Tone dialing
10	Fax fault alarm	OFF	CO9 -> FB10 = ON: Fault alarm to a fax machine
11	Fax dialing mode	OFF	CO9 -> FB11 = ON: Pulse dialing CO9 -> FB11 = OFF: Tone dialing

21 to 23	Meter bus #1 to Meter bus #3	OFF	CO9 -> FB21, 22, 23 = ON: Function block parameters: Meter bus address WMZ_ / 0 to 255 (255) Model code WMZ_ / P15, PS2, 1434, CAL3, APAtO, SLS, (1434) Reading mode WMZ_ / 24h, con, Coil (con)
----------------	------------------------------------	-----	--

FB Function block, WE Default settings

10.2 Parameter list

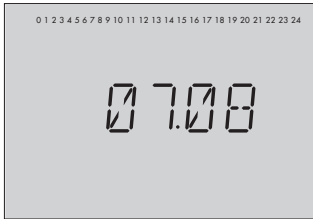
PA5: General parameters

Display	Parameter designation
 <p>0 1 2 3 4 5 6 7 8 9 10 11 12 13 14 15 16 17 18 19 20 21 22 23 24</p> <p>09:30</p>	Controller time
 <p>0 1 2 3 4 5 6 7 8 9 10 11 12 13 14 15 16 17 18 19 20 21 22 23 24</p> <p>07.08</p>	Date
 <p>0 1 2 3 4 5 6 7 8 9 10 11 12 13 14 15 16 17 18 19 20 21 22 23 24</p> <p>2003</p>	Year



Times-of-use

PA7: LON communication (only in devices with LON interface and CO7 -> FB00 = ON)

Display

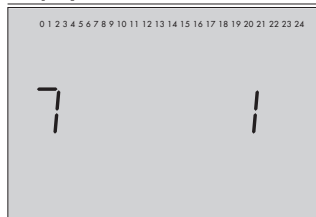
**Parameter designation**

Range of values (default settings)

LON communication (LON address)

1 to 20

PA9: Modbus/meter bus communication

Display

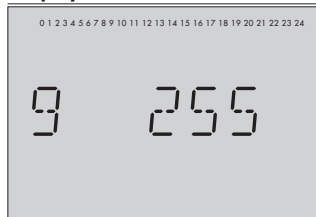
**Parameter designation**

Range of values (default settings)

Station address

1 to 247 (255)
(1 to 999 with CO9 -> FB04 = ON)

Only with CO9 -> FB00 = ON or CO9 -> FB01 = ON.



Baud rate

300 to 19200 (9600)

Only with CO9 -> FB00 = ON or CO9 -> FB01 = ON.

Display

Parameter designation

Range of values (default settings)

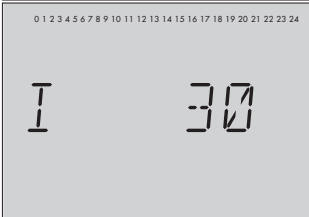

Cyclical initialization (I)

0 to 255 min (5 min)

Only with CO9 -> FB01 = ON.

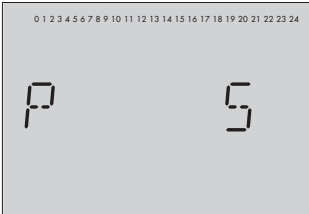

Modem dialing pause (P)

1 to 255 min (5 min)

Only with CO9 -> FB01 = ON.

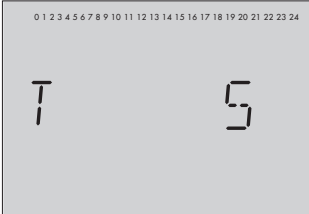

Modem time-out (t)

1 to 255 min (5 min)

Only with CO9 -> FB01 = ON.

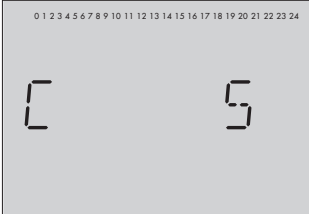

No. of redialing attempts (C)

0 to 99 (5)

Only with CO9 -> FB01 = ON.

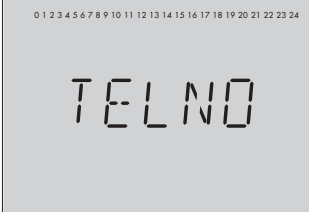

CO9 -> FB01 = ON: Phone no. of control station

CO9 -> FB10 = ON: Fax number

Max. 22 characters: 0 to 9,
P = pause, - = end of the number

Display

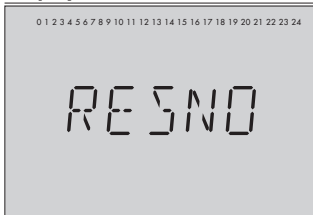

Parameter designation

Range of values (default settings)

CO9 -> FB01 = ON: Alternative phone no.

Max. 22 characters: 0 to 9,
P = pause, - = end of the number

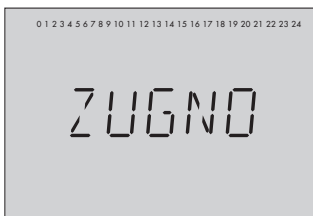
**CO9 -> FB06 = ON:** Access number

Max. 22 characters: 0 to 9,
P = pause, - = end of the number

**CO9 -> FB10 = ON:** Recipient's mobile phone no.

Max. 14 characters: 0 to 9,
P = pause, - = end of the number

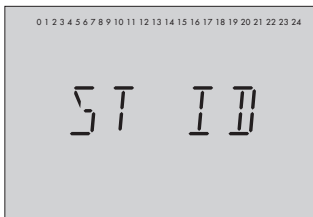
**CO9 -> FB10 = ON:** Station ID

Max. 14 characters: 0 to 9,
P = pause, - = end of the number

10.3 Sensor resistance tables

Resistance values with PTC resistors

Type 5224 Outdoor Temperature Sensors, Types 5264 and 5265 Flow and Return Flow Temperature Sensors, Type 5264 Storage Tank Temperature Sensors

°C	-20	-10	0	10	20	25	30	40	50	60	70	80	90	100	110	120
Ω	694	757	825	896	971	1010	1050	1132	1219	1309	1402	1500	1601	1706	1815	1925

Resistance values with Pt 1000 resistors

Type 5227-2 Outdoor Temperature Sensors, Type 5277-2 (thermowell required) and Type 5267-2 (contact sensor) Flow, Return Flow and Storage Tank Temperature Sensors. Type 5257-1, Type 5257-5 (room panel) Room Temperature Sensors.

°C	-35	-30	-25	-20	-15	-10	-5	0	5	10
Ω	862.5	882.2	901.9	921.6	941.2	960.9	980.4	1000.0	1019.5	1039.0

°C	15	20	25	30	35	40	45	50	55	60
Ω	1058.5	1077.9	1097.3	1116.7	1136.1	1155.4	1174.7	1194.0	1213.2	1232.4

°C	65	70	75	80	85	90	95	100	105	110
Ω	1251.6	1270.7	1289.8	1308.9	1328.0	1347.0	1366.0	1385.0	1403.9	1422.9

°C	115	120	125	130	135	140	145	150
Ω	1441.7	1460.6	1479.4	1498.2	1517.0	1535.8	1554.5	1573.1

Resistance values with Pt 100 resistors

Refer to the table for Pt1 000 resistors and divide the specified values by 10.

Type 5225 Outdoor Temperature Sensors, Types 5204, 5205-46 to -48 Flow and Return Flow Temperature Sensors, Types 5205-46 to -48 Storage Tank Temperature Sensors, Type 5255 Room Temperature Sensors.

10.4 Technical data

Voltage supply	230 V AC, 48 to 62 Hz
Power consumption	Approx. 8 VA
CPU	Motorola 68000
Program memory	128 KB
Random Access Memory (RAM)	512 KB
Flash memory	1 MB
Clock cycle	Approx. 500 ms (reading all inputs)
Timer	4 ms
Universal inputs	17 universal inputs, separately configurable as: - Resistance input Pt 100/500/1000, Ni 200/1000/2000, PTC/NTC, OHM (1–2k Ω) - Current input 0/4 to 20 mA (50 Ω parallel resistor); model 5171-0003 and larger: 0 to 10 V - Binary input, floating 2 binary inputs (BE1, BE2) as counter for pulses 0 to 5000 Hz
Analog inputs (separate)	2 analog inputs 0 to 10 V, use the same ground
Binary outputs	10 relay outputs (250 V AC, 2 A) 2 low-voltage signal outputs (50 V DC, 100 mA)
Analog outputs (separate)	2 analog outputs 0 to 10 V DC, use the same ground, max. load > 4.7 k Ω
Interfaces	1 x RS-232 for modem 1 x Local Operating Network (LON), free topology 1 x meter bus 1 x front RJ-45 jack
Ambient temperature	0 to 40 °C
Storage temperature	-20 to 60 °C
Degree of protection	IP 40
Class of protection	II
Degree of contamination	2
Overvoltage category	II
Humidity rating	F
Noise emission	According to EN 61000-6-3
Noise immunity	According to EN 61000-6-2
Weight	Approx. 0.6 kg

Interfaces

LON:	Communication with other TROVIS 5100 Series Controllers
RS-232:	Modem connection
Meter bus (M-Bus):	Connection with 15 V DC voltage supply for heat meter used to limit the flow rate/capacity
RJ 45 connector:	Interface for connection to a PC

10.5 Customer data

Station	
Operator	
Relevant SAMSON office	

Function blocks

	CO5	CO6	CO7	CO8	CO9
FB00					
FB01					
FB02					
FB03					
FB04					
FB05					
FB06					
FB07					
FB08					
FB09					
FB10					
FB11					
FB12					
FB13					
FB14					
FB15					
FB16					
FB17					
FB18					
FB19					
FB20					
FB21					
FB22					
FB23					

Times-of-use (PA5)

	Time-of-use 1		Time-of-use 2		Time-of-use 3		Time-of-use 4	
	Start – Stop (1)	Start – Stop (2)	Start – Stop (1)	Start – Stop (2)	Start – Stop (1)	Start – Stop (2)	Start – Stop (1)	Start – Stop (2)
Mon								
Tue								
Wed								
Thu								
Fri								
Sat								
Sun								

	Time-of-use 5		Time-of-use 6		Time-of-use 7		Time-of-use 8	
	Start – Stop (1)	Start – Stop (2)	Start – Stop (1)	Start – Stop (2)	Start – Stop (1)	Start – Stop (2)	Start – Stop (1)	Start – Stop (2)
Mon								
Tue								
Wed								
Thu								
Fri								
Sat								
Sun								

	Time-of-use 9		Time-of-use 10		Time-of-use 11		Time-of-use 12	
	Start – Stop (1)	Start – Stop (2)	Start – Stop (1)	Start – Stop (2)	Start – Stop (1)	Start – Stop (2)	Start – Stop (1)	Start – Stop (2)
Mon								
Tue								
Wed								
Thu								
Fri								
Sat								
Sun								

Parameters

Parameter PA7		Value range
LON communication		1 to 20
Parameters PA9		Value range
Station address (ST NR)		1 to 247
Baud rate (BAUD)		300 to 19200
Cyclical initialization (I)		0 to 255 min
Modem dialing pause (P)		1 to 255 min
Modem time-out (t)		0 to 255 min
No. of redialing attempts (C)		0 to 99
Phone no. of control station		–
Alternative phone no.		–
Access number		–
Recipient's mobile phone no.		–
Fax number		–
Station ID		–

Key number

1732

Index

A	
Arrow key(s)	5
B	
Baud rate	27
C	
Changeover key	5
Configuration level	13
Connection of	
PLC	36
Sensors	36
Controller time	8
Customer data	47
Cyclical initialization	27
D	
Default values (factory settings)	18
Display	6
E	
Enter key	5
Error status register	21
F	
Fault alarm	
To fax	23
To mobile phone	22
Faults	21 - 23
Flow Chart	12
Function Block Diagram	12
Function block list	38
Functions	
Activation/deactivation	13
H	
Holding register	21
I	
Info level	7
Inputs, configuration	16
Installation	
Panel mounting	33
Top hat rail mounting	33
Wall mounting	33
Instruction List	12
Interface	
Descriptions	46
Meter bus	29
RS-232-C	24 - 25
RS-485	26
Internal variable	12
ISaGRAF®	12
K	
Key number	16
L	
Ladder Diagram	12
LON communication	31 - 32
M	
Manual operation	19
Meter bus	29
Modem	
Dial-up modem	24
Leased line	24
Modem dialing pause	27
Modem time-out	27
O	
Overvoltage protection	35
P	
Parameter level	15
Parameter list	40
Programming	12

R

Redialing attempts	27
Reset key	5

S

Sensor calibration	16
Sensor resistance values	44
Sequential Function Chart	12
Station address	27
Structured Text	12
Summer time/winter time changeover . . .	20

T

Technical data	45
Times-of-use	9
Transmission of	
Controller time	32
Outdoor temperature	32

W

Wiring plan	37
-----------------------	----

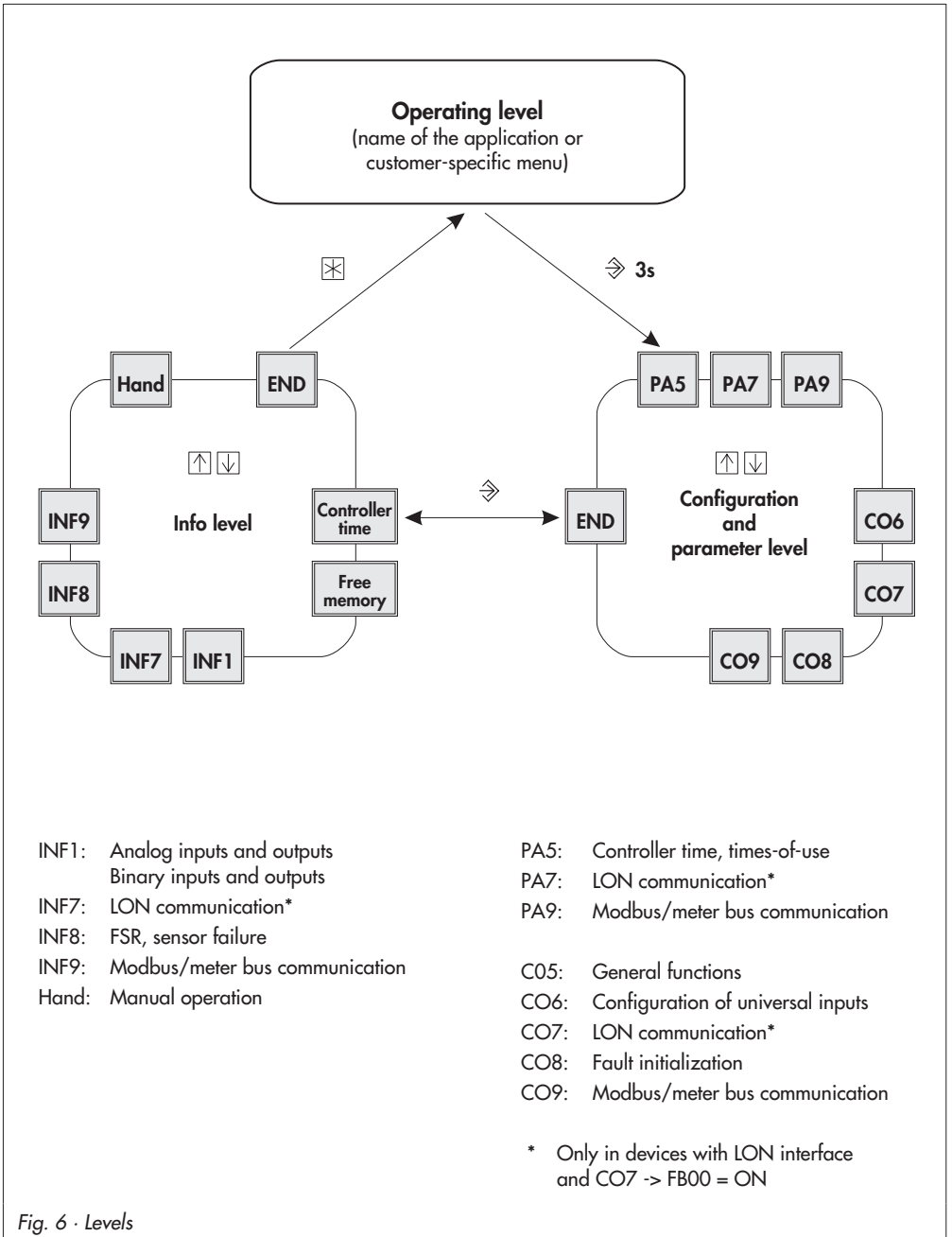

Fig. 6 · Levels

Frequently used abbreviations

AA	Analog output (AO)	IL	Instruction List (ISaGRAF® programming language)
AE	Analog input (AI)	LD	Ladder Diagram (ISaGRAF® programming language)
BA	Binary output	LON	Local Operating Network
BE	Binary input	PA	Parameter level
CO	Configuration level	PLC	Programmable Logic Controller
FB	Function block	SFC	Sequential Function Chart (ISaGRAF® programming language)
FBD	Function Block Diagram (ISaGRAF® programming language)	ST	Structured Text (ISaGRAF® programming language)
FC	Flow Chart (ISaGRAF® programming language)	WE	Default settings
FSR	Error status register	WMZ	Heat or water meter
GLT	Building control station		
HR	Holding register		



SAMSON AG · MESS- UND REGELTECHNIK
Weismüllerstraße 3 · 60314 Frankfurt am Main · Germany
Phone: +49 69 4009-0 · Fax: +49 69 4009-1507
Internet: <http://www.samson.de>

EB 5171 EN

2006-05