

Automation System TROVIS 5400 Heating and District Heating Controller TROVIS 5433



Mounting and Operating Instructions

EB 5433 EN

Firmware version 1.2x
Edition January 2008



Disclaimer of liability

We are constantly developing our products and therefore, reserve the right to change the product or the information contained in this document at any time without notice.

We do not assume any liability for the accuracy or completeness of these mounting and operating instructions. Moreover, we do not guarantee that the buyer can use the product for an intended purpose. SAMSON rejects any liability for claims by the buyer, especially claims for compensation including lost profits or any other financial loss, except the damage was caused intentionally or by gross negligence. If an essential term of the contract is breached by negligence, SAMSON's liability is limited to the foreseeable damage.

Safety instructions



- ▶ The device may only be assembled, started up or operated by trained and experienced personnel familiar with the product. Proper shipping and appropriate storage are assumed.
- ▶ The controller has been designed for use in electrical power systems. For wiring and maintenance, you are required to observe the relevant safety regulations.

Contents

1	Operation	6
1.1	Operating elements	6
1.1.1	Rotary pushbutton	6
1.1.2	Rotary switches	6
1.2	Operating modes	7
1.3	Display	8
1.4	Displaying data	9
1.5	Setting the controller time	10
1.6	Setting the times-of-use	11
1.6.1	Setting public holidays	13
1.6.2	Setting vacation periods	15
1.7	Presetting temperature set points	17
2	Start-up	18
2.1	Setting the system code number	18
2.2	Activating and deactivating functions	19
2.3	Changing parameters	21
2.4	Calibrating sensors	22
2.5	Resetting to default values	24
3	Manual operation	25
4	Systems	26
5	Functions of the heating circuit	36
5.1	Weather-compensated control	36
5.1.1	Gradient characteristic	37
5.1.2	4-point characteristic	38
5.2	Fixed set point control	39
5.3	Drying of jointless floors	39
5.4	Outdoor temperature dependent deactivation	40
5.4.1	OT deactivation value rated operation	40
5.4.2	OT deactivation value reduced operation	41
5.4.3	OT activation value rated operation	41
5.4.4	Summer mode	42
5.5	Delayed outdoor temperature adaptation	42
5.6	Remote operation	43
5.6.1	Room panel	43
5.6.2	Floating switch	44
5.7	Optimization	44
5.7.1	Advance heating depending on outdoor temperature	44

5.7.2	Optimization with room sensor	45
5.8	Flash adaptation	46
5.9	Room temperature dependent control	46
6	Functions of the DHW circuit.	48
6.1	DHW heating in the storage tank system	48
6.2	DHW heating in the storage tank charging system	50
6.3	DHW heating in the instantaneous water system	53
6.4	Intermediate heating operation	54
6.5	Parallel pump operation	54
6.6	Operation of circulation pump during storage tank charging	54
6.7	Priority operation	55
6.7.1	Reverse control	55
6.7.2	Set-back operation	55
6.8	Forced charging of the DHW storage tank	56
6.9	Thermal disinfection of the DHW storage tank	56
6.10	Vacation periods and public holidays for DHW heating.	58
7	System-wide functions	59
7.1	Automatic summer time/winter time changeover	59
7.2	Frost protection	59
7.3	Forced operation of the pumps.	59
7.4	Return flow temperature limitation	60
7.5	Condensate accumulation control	61
7.6	Three-step control	62
7.7	On/off control	62
7.8	Requesting/processing external demand	63
7.9	Locking the manual level.	67
7.10	Locking the rotary switches	67
8	Operational faults	68
8.1	Error alarm list	68
8.2	Sensor failure	68
8.3	Temperature monitoring	69
8.4	Collective alarm.	69
9	Memory pen	70
10	Installation	71
11	Electrical connection.	73
12	Appendix.	76

12.1	Function block lists	76
12.2	Parameter lists	83
12.3	Sensor resistance tables	90
12.4	Technical data	91
12.5	Customer data	92
	Index	97
	Abbreviations	99

1 Operation

The controller is ready for use with the temperatures and operating schedules preset by the manufacturer.

On start-up, the **current time and date** need to be adjusted at the controller (-> section 1.5).

1.1 Operating elements

The operating controls are located in the front panel of the controller and protected by a Plexiglas door with an integrated quick guide.

1.1.1 Rotary pushbutton

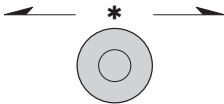

Rotary pushbutton

Turn (↻):
Display, select parameters and function blocks

Press *:
Confirm adjusted selection or settings

1.1.2 Rotary switches

Rotary switch for "Configuration and parameterization"

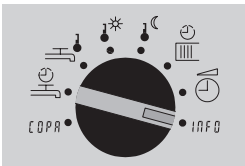

COPA Switch to configuration and parameter level

 Times-of-use for DHW circulation pump

 DHW temperature set point

 Day set point (rated room temperature)

 Night set point (reduced room temperature)

 Times-of-use for heating

 Controller time: setting the current time, date and year

INFO Switch to information level
(view measured values and their set points/limit values)

Rotary switch for "Operating modes"

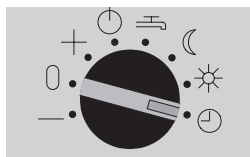

- Manual operation: valve closes
- 0 Manual operation: valve stationary
- + Manual operation: valve opens
- ⊖ Control operation deactivated, frost protection only
- ⇨ DHW heating active, heating switched off
- ☾ Night mode (reduced operation)
- ☀ Day mode (rated operation)
- ⌚ Automatic mode (operation according to time schedule)

1.2 Operating modes

Day mode (rated operation) ☀

Regardless of the programmed times-of-use and summer mode, the controller uses the set points relevant for rated operation.

The *DHW temperature set point* remains constantly active in system Anl 6.

Night mode (reduced operation) ☾

Regardless of the programmed times-of-use, the controller uses the set points relevant for reduced operation.

The *Sustained DHW temperature* remains constantly active in system Anl 6.

Automatic mode ⌚

During the programmed times-of-use, the controller works in rated operation. Outside these times-of-use, the controller is in reduced operation, unless control operation is deactivated depending on the outdoor temperature. The controller switches automatically between both operating modes.

Manual operation - 0 +

Valves and pumps can be controlled manually (-> section 3).

The default setting of the circulation pump is permanent operation.

1.3 Display

During operation, the display indicates the current time as well as information about the operation of the controller. The days of the week are represented by black squares below the row of numbers at the top of the display (1 = Monday, 2 = Tuesday, and shown here, 7 = Sunday). Icons indicate the operating status of the controller.

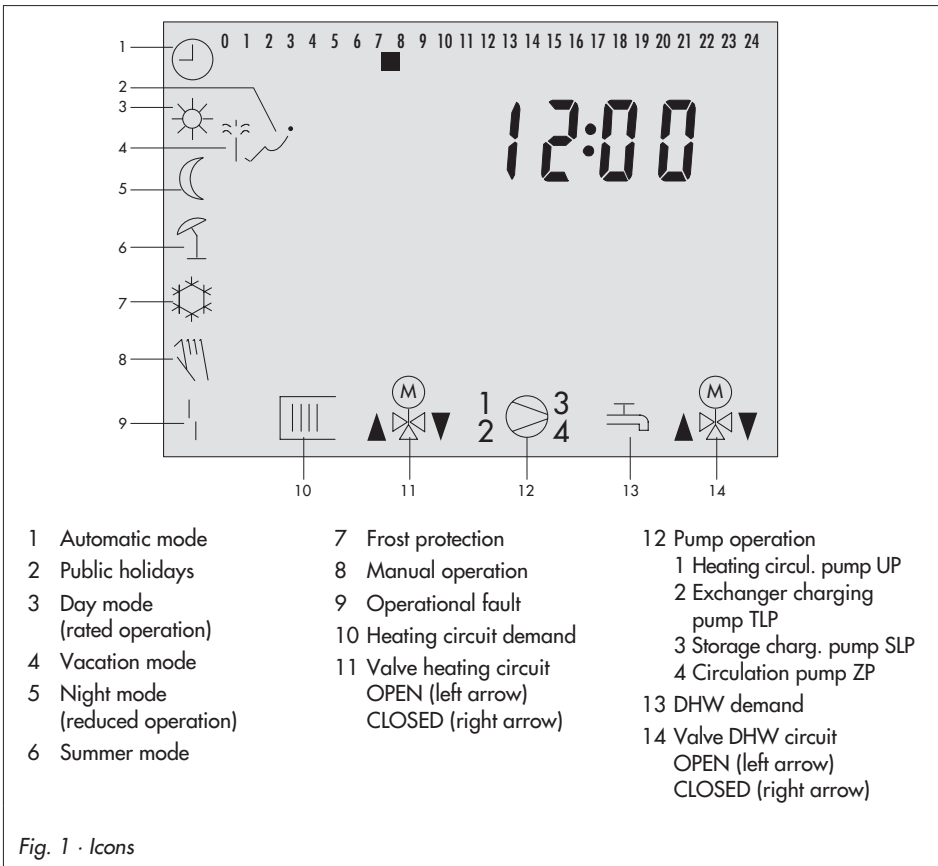

The controller status can be displayed in operating level (→ section 1.4).

1.4 Displaying data

The time and temperature values of connected sensors and their set points can be retrieved and displayed in the info level.

Proceed as follows:

Turn rotary switch "Configuration and parameterization" to INFO.

Display shows: time _ _ : _ _

The black squares below the row of numbers at the top of the display in this case represent the times-of-use.

- ☞ Depending on the configuration of the controller, different data points are displayed in info level.

 Room temperature, RS

 Outdoor temperature, AS

 /  Temperature at flow sensor VS1, heating circuit/primary exchanger circuit

 Temperature at return flow sensor RüS

  /  Temperature at flow sensor VS2, DHW circuit (Anl 3 to 5)

 ,  Temperature at storage sensor (Anl 2 to 4)

  Temperature at return flow sensor RüS_TW (Anl 5)

- * Compare the set point/limit temperature and the actual temperature.



1.5 Setting the controller time

The current time and date need to be set immediately after start-up or after a power failure lasting more than 24 hours. This is the case when the time blinks on the display.

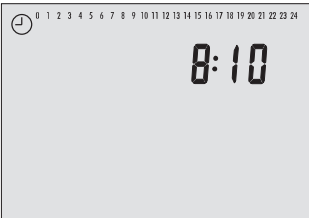
Proceed as follows:





Turn rotary switch "Configuration and parameterization" to data point  "Controller time".
Display shows: time

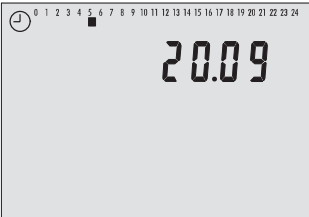

- * Activate editing mode for controller time.
 blinks.
-  Edit time.



- * Confirm time.
Display shows: date (day.month)
The individual week days which are represented by black squares below the row of numbers can be read off at the top of the display:
1 = Monday, 2 = Tuesday, ..., 5 = Friday (shown here)

- * Activate editing mode for date.
 blinks.
-  Edit date.



- * Confirm date.
Display shows: year
- * Activate editing mode for year.
 blinks.
-  Edit year.
- * Confirm year.
Display shows: time



Return rotary switch "Configuration and parameterization" to INFO.
Display shows: time

1.6 Setting the times-of-use

Three times-of-use can be set for each day of the week.

If a time-of-use is not required, its start and stop times must be set to identical times.

The times-of-use for heating and the DHW circulation pump are set using the top rotary switch:

Times-of-use	Position
Heating	
DHW circulation pump	

Parameters	WE*	Rotary switch / Range of values
Period/day	1	1, 2, 3, 4, 5, 6, 7 with 1-7 = every day, 1 = Monday, 2 = Tuesday, ..., 7 = Sunday
Start first time-of-use	7:00	0:00 h to 24:00 h; in steps of 30 minutes
Stop first time-of-use	22:00	0:00 h to 24:00 h; in steps of 30 minutes
Start second time-of-use	22:00	0:00 h to 24:00 h; in steps of 30 minutes
Stop second time-of-use	22:00	0:00 h to 24:00 h; in steps of 30 minutes
Start third time-of-use	22:00	0:00 h to 24:00 h; in steps of 30 minutes
Stop third time-of-use	22:00	0:00 h to 24:00 h; in steps of 30 minutes
*Default setting (WE) valid for heating (switch position )		

Note!

The times-of-use for DHW heating are set in parameter level PA2 similar to the times-of-use for heating and the DHW circulation pump.

Proceed as follows:

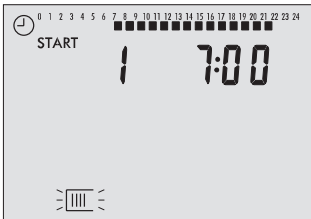
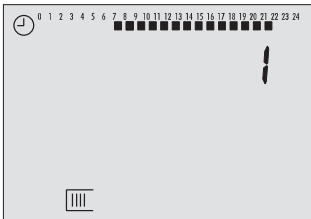

Turn rotary switch “Configuration and parameterization” to “Times-of-use”.

Display shows: **1**

- (C) Select period/day for times-of-use:
1 = Monday, 2 = Tuesday , ..., 7 = Sunday,
1-7 = daily
- * Activate editing mode for period/day.
Display shows: **1***, **START**
* The display 1 (2, 3) indicates the first (second, third) time-of-use.
- * Activate editing mode for start time.
⌚ and ████ blink.
- (C) Edit start time (steps of 30 minutes).
- * Confirm start time.
Display shows: **STOP**
- (C) Edit stop time (steps of 30 minutes).
- * Confirm stop time.
Display shows: **2**, **START**
The second and third time-of use are set similar to the first one.
- (C) Select **End**.
- * Exit active data point “Period/day”.

To set the times-of-use for additional days, repeat the instructions in the fields highlighted in gray.

Return rotary switch “Configuration and parameterization” to **INFO**.

Display shows: time

Note!

Do not use the 1–7 menu to check the adjusted times-of-use as only the times-of-use for Monday are displayed under this data point, which are then adopted for the whole week.



1.6.1 Setting public holidays

On public holidays, the times-of-use specified for Sunday apply. A maximum of 20 public holidays may be entered.

Parameter	WE	Level / Range of values
Public holidays	–	PA-SYS / 01.01 to 31.12 (1 Jan to 31 Dec)
Adopt public holidays and vacations for DHW	0	CO2 -> F07 - 1

Proceed as follows:

Turn rotary switch "Configuration and parameterization" to **COPA**.
Display shows: **0**, **NR** blinks.

- ⌚ Set valid key number.
- * Confirm key number.
Display shows: **PA 1**
- ⌚ Select parameter level PA-SYS.
- * Open parameter level PA-SYS.
- ⌚ Select "Public holidays".
Display shows: 
- * Open "Public holidays".
- ⌚ If applicable, select --.--.
- * Activate editing mode for public holiday.
 blinks.
- ⌚ Edit public holiday.
- * Confirm public holiday.

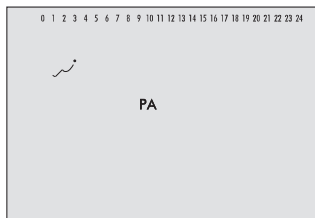

To enter additional public holidays, re-select --.-- and repeat the steps in the fields highlighted in gray.

⌚ Select **End**.

- * Exit parameter level.
Display shows: CO1

Return rotary switch "Configuration and parameterization" to **INFO**.
Display shows: time

Note!

Public holidays that are not assigned to a specific date should be deleted by the end of the year so that they are not carried on into the following year.

Deleting a public holiday:

- ⌚ Under "Public holidays", select the holiday you wish to delete.
- * Confirm selection.
- ⌚ Select --.-- (display --.-- is adjustable between 31.12 and 01.01).
- * Delete public holiday.

1.6.2 Setting vacation periods

During vacation periods, the heating constantly remains in reduced operating mode. The DHW heating is monitored for frost protection, if necessary. A maximum of 10 vacation periods can be entered.

Parameter	WE	Level / Range of values
Vacation period (START, STOP)	–	PA-SYS / 01.01 to 31.12 (1 Jan to 31 Dec)
Adopt public holidays and vacations for DHW	0	CO2 -> F07 - 1

Proceed as follows:

Turn rotary switch "Configuration and parameterization" to **COPA**.
Display shows: **0**, **NR** blinks.

⌚ Set valid key number.

* Confirm key number.
Display shows: **PA 1**

⌚ Select parameter level PA-SYS.

* Open parameter level PA-SYS.

⌚ Select "Vacation periods".
Display shows: **☞**

* Open "Vacation periods"
Display shows: **START**

⌚ If applicable, select **-- --**.

* Activate editing mode for start date of vacation period.
START and **☞** blink.

⌚ Edit start date of vacation period.

* Confirm start date of vacation period.
Display shows: **STOP**, *start date of vacation period*

⌚ Edit end of vacation period.

* Confirm end of vacation period.

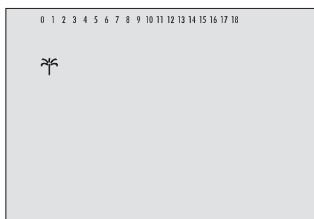

To enter additional vacation periods, re-select **-- --** and repeat the steps in the fields highlighted in gray.

- ⌂ Select **End**.
 - * Exit parameter level.
Display shows: CO1
Return rotary switch "Configuration and parameterization" to INFO.
Display shows: time
-

Note!

Vacation periods should be deleted by the end of the year so that they are not carried on into the following year.

Deleting vacation periods:



- ⌂ Under "Vacation periods", select the start date of the period you wish to delete.
- * Confirm selection.
- ⌂ Select --.-- (display --.-- is adjustable between 31.12 and 01.01).
- * Delete vacation period.

1.7 Presetting temperature set points

For the heating circuit, the desired room temperatures during the day (*Day set point*) and during the night (*Night set point*) can be preset.

In the DHW circuit, the temperature you wish the domestic hot water to be heated to can be adjusted.

The temperature set points are adjusted using the top rotary switch:

Desired temperature set point	Position
Day set point	
Night set point	
DHW temperature set point	

Parameters	WE	Rotary switch / Range of values
Day set point	20 °C	10 to 40 °C
Night set point	15 °C	10 to 40 °C
DHW temperature set point	55 °C	Min. to max. DHW temperature

Proceed as follows:

Turn rotary switch "Configuration and parameterization" to "Set point temperature".
Display shows: temperature value

- * Activate editing mode for set point temperature.
Display blinks.

 Edit set point temperature.

- * Confirm set point temperature.

Return rotary switch "Configuration and parameterization" to INFO.
Display shows: time

2 Start-up

The modifications of the controller configuration and parameter settings described in this section can only be carried out after the valid key number has been entered.

The valid key number for initial start-up can be found on page 96. To avoid unauthorized use of the key number, remove the page or make the key number unreadable.

2.1 Setting the system code number

Six different hydraulic schemes are available. Each system configuration is represented by a system code number. The different schemes are dealt with in section 4. Available controller functions are described in sections 5, 6 and 7.

Changing the system code number resets previously adjusted function blocks to their default values. Function block parameters and parameter level settings remain unchanged. The system code number is set in the configuration level.

Proceed as follows:

Turn rotary switch "Configuration and parameterization" to **COPA**.
Display shows: **0, NR** blinks.

⌚ Set valid key number.

* Confirm key number.
Display shows: **PA 1**

⌚ Select **Anl**.

* View current system code number.

* Activate editing mode for system code number.
Anl blinks.

⌚ Set system code number.

* Confirm system code number.
Display shows: **End**

* Exit data point "System code number".

Return rotary switch "Configuration and parameterization" to **INFO**. Display shows: time

2.2 Activating and deactivating functions

A function is activated via the associated function block. The numbers 0 to 24 in the top row of the display represent the respective function block numbers. When a configuration level is opened, the activated function blocks are indicated by a black square on the right-hand side below the function block number. For more details on function blocks, refer to section 12.1.

The functions are grouped by topics:

- ▶ CO1: Heating circuit
- ▶ CO2: DHW heating
- ▶ CO-SYS: System-wide

Proceed as follows:

Turn rotary switch "Configuration and parameterization" to COPA.
Display shows: **0**, **NR** blinks.

⌚ Set valid key number.

* Confirm key number.
Display shows: **PA 1**

⌚ Select configuration level.

* Open configuration level.

⌚ Select function block.

Activated function blocks are marked by "- 1".
Deactivated function blocks are marked by "- 0".

* Activate editing mode for function block.
F__ blinks.

⌚ Activate function block.
Display shows: **F__ - 1**

Or:

⌚ Deactivate function block.
Display shows: **F__ - 0**

- * Confirm settings.
If the function block is not closed, further function block parameters can be adjusted.
Proceed as follows:
 1. Open data point.
 2. Make desired changes and confirm.
 3. If applicable, the next function block parameter is displayed.
When all function block parameters have been adjusted, select **End** and confirm.
The active function block is closed.

An active function block is represented by a black square on the right-hand side below the function block number.

To adjust additional function blocks, repeat the steps in the fields highlighted in gray.

- () Select **End**.
- * Exit configuration level.
Return rotary switch "Configuration and parameterization" to INFO. Display shows: time

2.3 Changing parameters

Depending on the adjusted system code number and the activated functions, not all parameters listed in the parameter list in the Appendix (-> section 12.2) might be available.

The parameters are grouped by topics:

- ▶ PA1: Heating circuit
- ▶ PA2: DHW heating
- ▶ PA-SYS: Public holidays and vacation periods

Proceed as follows:

Turn rotary switch "Configuration and parameterization" to **COPA**.

Display shows: **0, NR** blinks.

⌚ Set valid key number.

* Confirm key number.

Display shows: **PA 1**

⌚ Select parameter level.

* Open parameter level.

⌚ Select parameter.

* Activate editing mode for parameter.

⌚ Set parameter.

* Confirm parameter.

To adjust additional parameters, repeat the steps in the fields highlighted in gray.

⌚ Select **End**.

* Exit parameter level.

Return rotary switch "Configuration and parameterization" to **INFO**. Display shows: time

2.4 Calibrating sensors

The connected sensors are calibrated in configuration level CO-SYS.

The following applies:

- ▶ CO-SYS -> F02 - 1: Pt 1000 sensors (default)
- ▶ CO-SYS -> F02 - 0: PTC sensors

The resistance values of the sensors can be found on page 91.

If the temperature values displayed on the controller differ from the actual temperatures, the measured values of all connected sensors can be changed or readjusted. To calibrate a sensor, the currently displayed sensor value must be changed to match a temperature (reference value) measured directly at the point of measurement.

Activate the sensor calibration in CO-SYS over function block F08.

An incorrect sensor calibration can be deleted by setting F08 - 0.

Proceed as follows:

Turn rotary switch "Configuration and parameterization" to COPA.
Display shows: **0**, **NR** blinks.

- ⌚ Set valid key number.
- * Confirm key number.
Display shows: **PA 1**
- ⌚ Select configuration level CO-SYS.
- * Open configuration level CO-SYS.
- ⌚ Select function block F08.
- * Activate editing mode for function block F08.
- ⌚ Activate function block F08 (F08 - 1).
- * Confirm function block settings.
- ⌚ Select sensor icon:



Room sensor RS



Outdoor sensor AS

 Flow sensor VS1

 Return flow sensor RüF

 /  Flow sensor VS2/Vs1 (system Anl 6)

 Storage sensor SS1

 Storage sensor SS2

 Return flow sensor RüS_TW

* Activate editing mode for measured value.

(C) Correct measured value.

Read the actual temperature directly from the thermometer at the point of measurement and enter this value as the reference temperature.

* Confirm corrected measured value.

Additional sensors are calibrated similarly.

(C) Select **End**.

* Exit function block F08.

(C) Select **End**.

* Exit configuration level CO-SYS.

Return rotary switch "Configuration and parameterization" to INFO. Display shows: time

2.5 Resetting to default values

All parameters as well as the function block parameters can be reset to their default settings (WE).

Proceed as follows:

Turn rotary switch "Configuration and parameterization" to **COPA**.
Display shows: **0**, **NR** blinks.

- ⌚ Set valid key number.
 - * Confirm key number.
 - ⌚ Select configuration level CO-SYS.
 - * Open configuration level CO-SYS.
 - ⌚ Select function block F09.
 - * Activate editing mode for function block F09.
 - ⌚ Set F09 - 1.
 - * Reset parameters to their default values.
 - ⌚ Select **End**.
 - * Exit configuration level CO-SYS.
- Return rotary switch "Configuration and parameterization" to **INFO**. Display shows: time

3 Manual operation

Switch to manual operating mode to access all outputs (see wiring diagram in section 11). When manual operation is activated using the rotary switch for "Operating modes", the rotary switch "Configuration and parameterization" should be in position INFO, otherwise the pump level cannot be accessed over the rotary pushbutton.

Proceed as follows:

Turn rotary switch "Configuration and parameterization" to INFO.

Turn "Operating modes" switch to +, 0 or -.

Display shows: 

 Select pump level PU.

* Open pump level PU.

Display shows: PU 1 - 0 / PU 1 - 1: heating circulation pump switched off/on

 Select pump:

PU 1: Heating circulation pump UP

PU 2: Exchanger charging pump TLP (ZP / Anl 5)

PU 3: Storage tank charging pump SLP (DHW valve opens / Anl 5)

PU 4: Circulation pump ZP (DHW valve closes / Anl 5)

PU 5: Binary output BA (TLP / Anl 5)

* Confirm selection. PU blinks.

 Activate/ deactivate output:

PU _ - 0: deactivate pump/binary output

PU _ - 1: activate pump/binary output

* Confirm edited settings.

The modified values remain active as long as the controller is in the manual mode.

 Select **End**.

* Exit pump level PU.

Turn bottom rotary switch to the desired operating mode.

Note!

Setting the rotary switch to position "Manual operation" (+ 0 -) also sets PU1 - 1 (not in system Anl 6). All other outputs are deactivated.

4 Systems

Six different hydraulic schemes are available. The systems can be configured both as primary and secondary systems. The fundamental hydraulic difference between a primary and a secondary system (heat exchanger in the heating/DHW circuit replaced by a mixing valve) is illustrated in Fig. 2. The controller settings do not have to be changed.

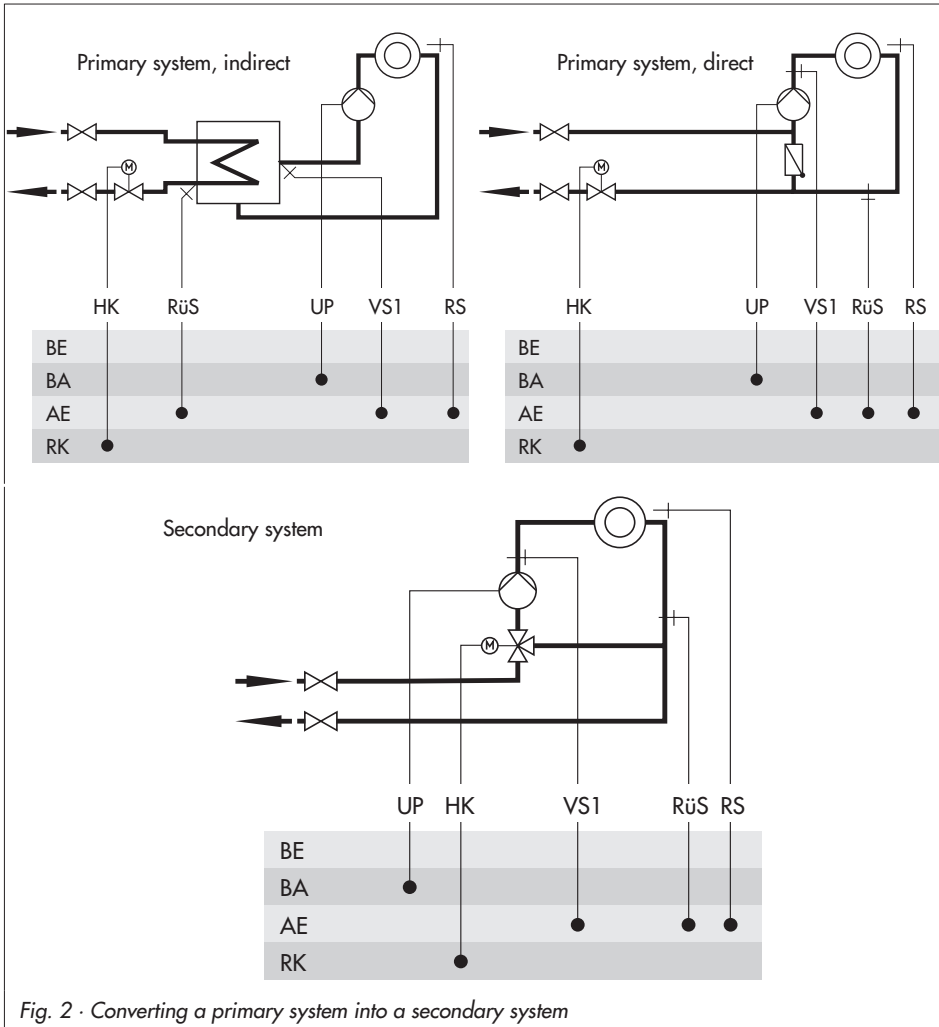
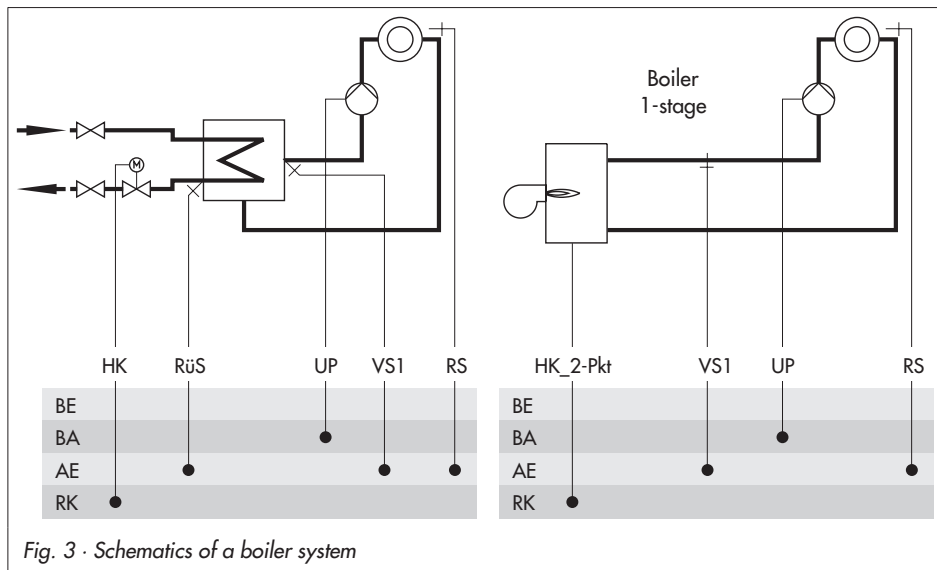

Fig. 2 · Converting a primary system into a secondary system

Boiler systems:

Based on the systems Anl 1 to Anl 3, one-stage boiler systems can be set up.
The boiler can be controlled by an on/off output (CO-SYS -> F05 - 0).



HK Heating circuit
RüS Return flow sensor
UP Circulation pump
VS Flow sensor
RS Room sensor

BE Binary input
BA Binary output
AE Analog input
RK Control loop

System Anl 1

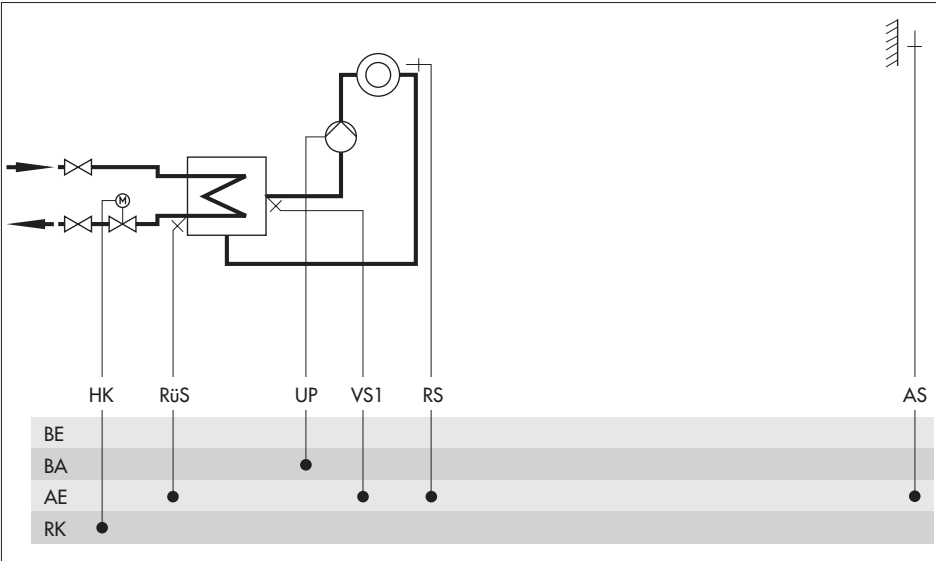

Default values

CO1 -> F01	- 0 (without RS)
CO1 -> F07	- 1 (with AS)
CO-SYS -> F01	- 1 (with RüS)

System Anl 2

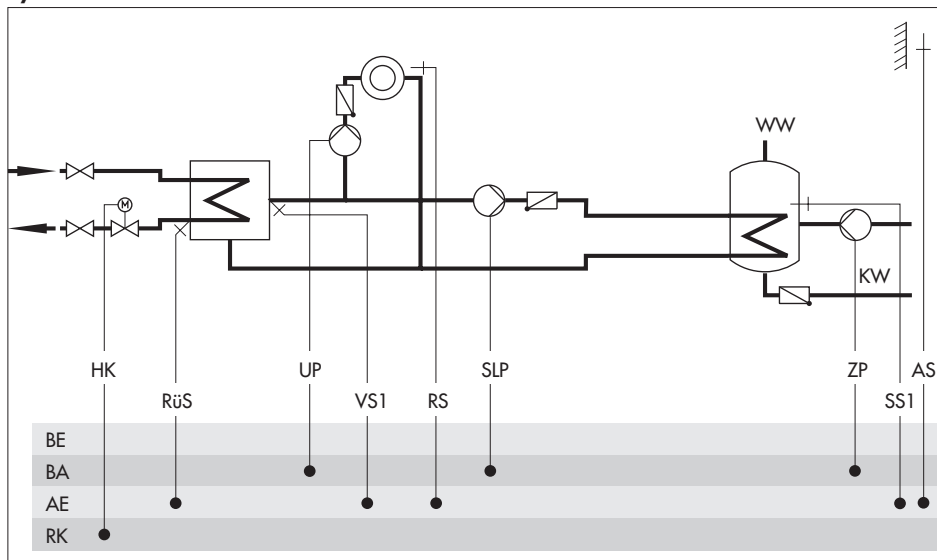

Default values

CO1 -> F01	- 0 (without RS)
CO1 -> F07	- 1 (with AS)
CO2 -> F01	- 1 (with SS1)
CO2 -> F02	- 0 (without SS2)
CO-SYS -> F01	- 1 (with RüS)

HK	Heating circuit	BE	Binary input
RüS	Return flow sensor	BA	Binary output
UP	Circulation pump	AE	Analog input
VS	Flow sensor	RK	Control loop
RS	Room sensor		
SLP	Storage tank charging pump		
WW	Hot water		
KW	Cold water		
ZP	Circulation pump		
SS	Storage tank sensor		
AS	Outdoor sensor		

System Anl 2, settings deviating from default settings

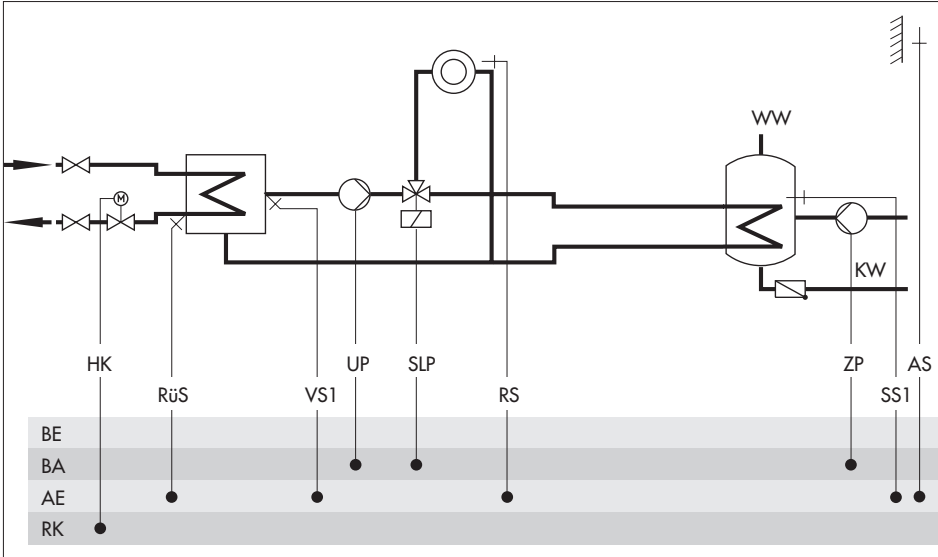

Settings deviating from default values

CO2 -> F10	- 0 (priority for DHW heating)
CO2 -> F06	- 1, option 2 (control of changeover valve and UP)

System Anl 3

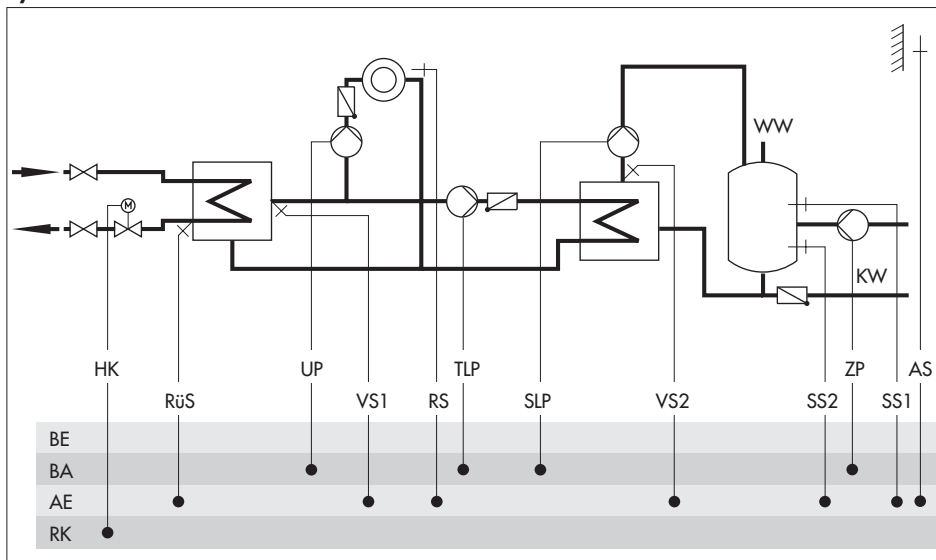

Default values		
CO1 -> F01		- 0 (without RS)
CO1 -> F07		- 1 (with AS)
CO2 -> F01		- 1 (with SS1)
CO2 -> F02		- 1 (with SS2)
CO2 -> F03		- 0 (without VS2)
CO-SYS -> F01		- 1 (with RüS)

System Anl 4

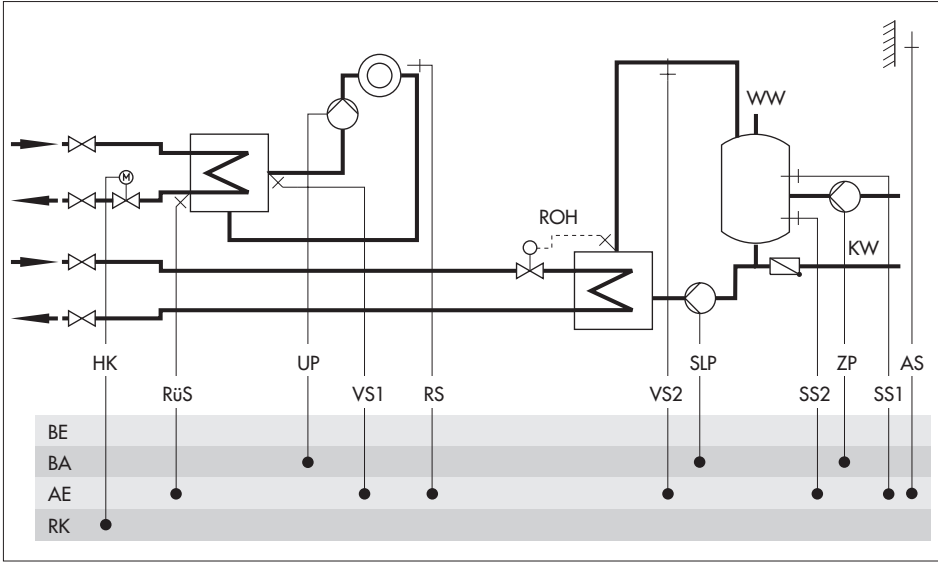

Default values		
CO1 -> F01		- 0 (without RS)
CO1 -> F07		- 1 (with AS)
CO2 -> F01		- 1 (with SS1)
CO2 -> F02		- 1 (with SS2)
CO2 -> F09		- 0 (without VS2)
CO-SYS -> F01		- 1 (with RüS)

Note!

The charging temperature is regulated by a self-operated regulator (ROH).

System Anl 5

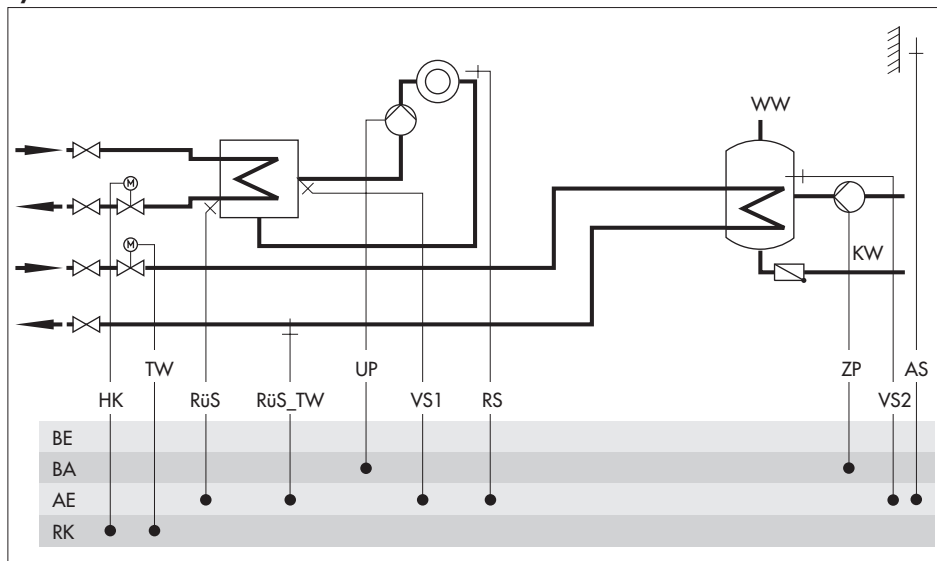

Default values

CO1 -> F01	- 0 (without RS)
CO1 -> F07	- 1 (with AS)
CO2 -> F11	- 1 (storage system uses three-step control)
CO2 -> F12	- 1 (with RüS_TW)
CO-SYS -> F01	- 1 (with RüS)

Using setting CO2 -> F11 - 0, a temperature valve is configured instead of the three-step control valve DHW.

A demand with CO-SYS -> F11 - 1 is exclusively processed in the heating circuit.

System Anl 5, settings deviating from default settings

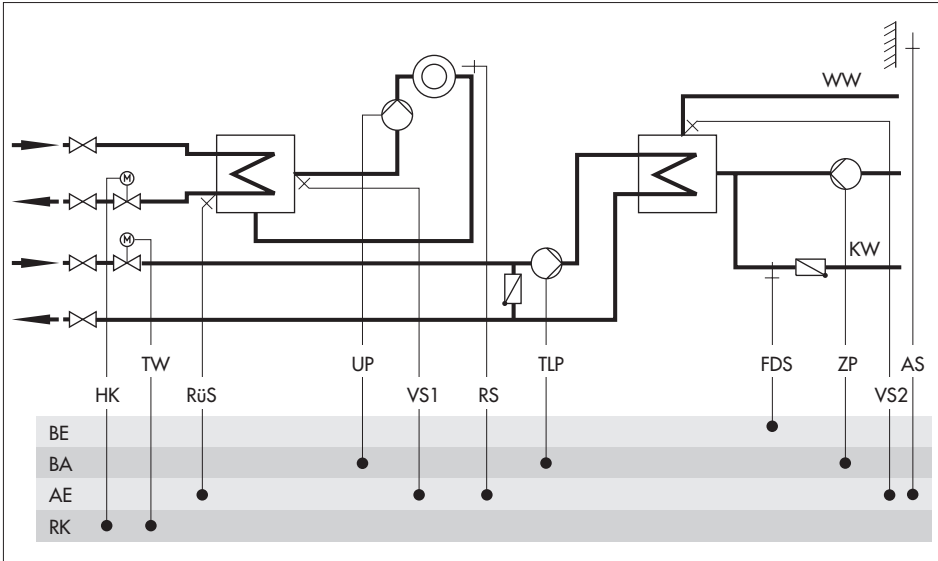

Settings deviating from default values

CO2 -> F14

- 1 (system with instantaneous water heater including hydraulic pressure switch)

Note!

A Pt 1000 sensor must always be used for the sensor VF2 regardless of the configuration of the other sensors.

System Anl 6

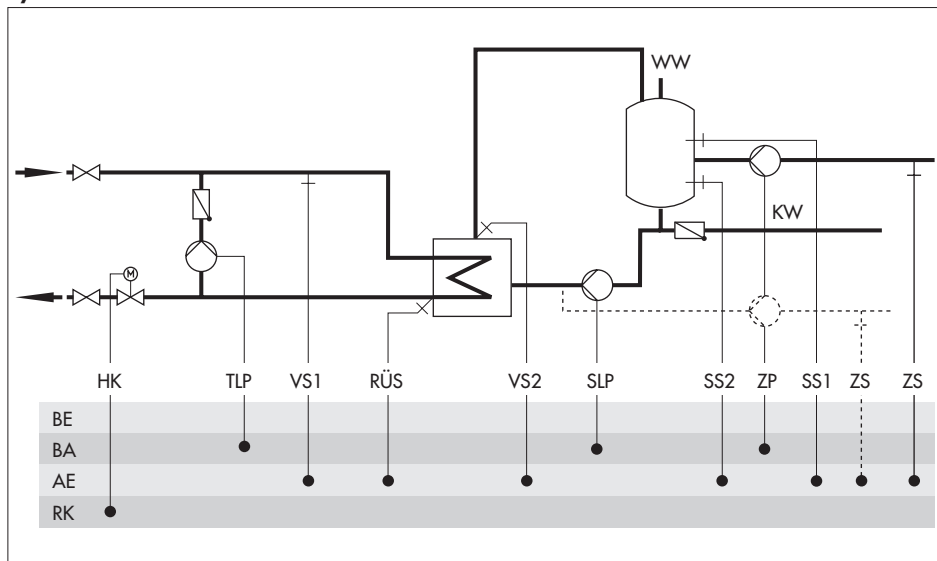

Default values	
CO2 -> F01	- 1 (with SS1)
CO2 -> F02	- 1 (with SS2)
CO2 -> F03	- 0 (without VS2)
CO2 -> F17	- 0 (without ZS)
CO-SYS -> F01	- 1 (with Rüs)

5 Functions of the heating circuit

Which controller functions are available depends on the selected system code number.

5.1 Weather-compensated control

When weather-compensated control is used, the flow temperature is adjusted depending on the outdoor temperature. The heating characteristic in the controller defines the flow temperature set point as a function of the outdoor temperature (→ Fig. 4). The outdoor temperature required for weather-compensated control is either measured at the outdoor sensor or received as an 0 to 10 V signal.

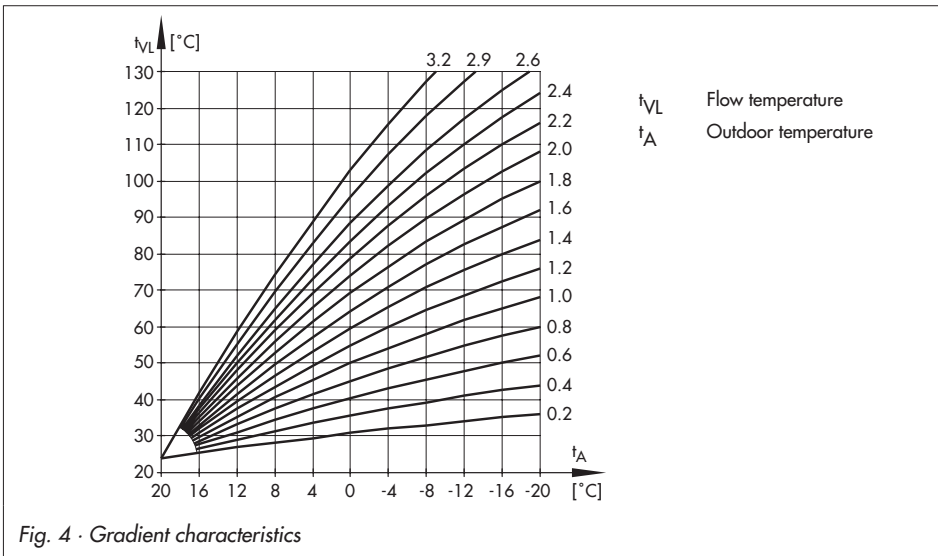

Function	WE	Configuration
Outdoor temperature t_A	1	CO1 -> F07 - 1

If you wish to alternatively receive the outdoor temperature as an 0 to 10 V signal, the following additional configurations must be made:

Functions	WE	Configuration
Outdoor temp. 0 to 10 V at input UE	0	CO1 -> F08 - 1
External demand, demand processing	0	CO-SYS -> F11 - 0

5.1.1 Gradient characteristic

Basically, the following rule applies: a decrease in the outdoor temperature causes the flow temperature to increase in order to keep the the room temperature at a constant temperature. By varying the parameters *Gradient* and *Level*, you can adapt the characteristic to your individual requirements:

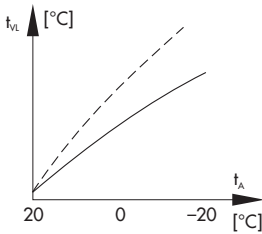

The gradient needs to be increased **if the room temperature drops when it is cold outside**

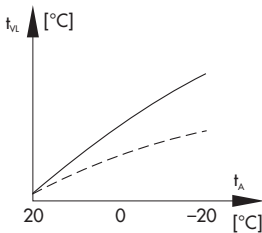

The gradient needs to be decreased **if the room temperature rises when it is cold outside.**

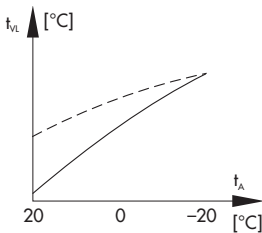

The level needs to be increased and the gradient decreased **if the room temperature drops when it is mild outside.**

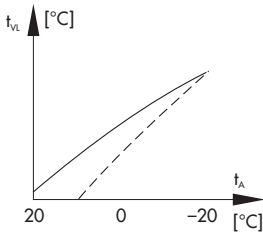

The level needs to be decreased and the gradient increased **if the room temperature rises when it is mild outside.**

Outside the times-of-use, reduced set points are used for control:

The reduced flow set point is calculated as the difference between the adjusted values for *Day set point* (rated room temperature) and *Night set point* (reduced room temperature). The parameters *Max. flow temperature* and *Min. flow temperature* mark the upper and lower limits of the flow temperature. A separate gradient characteristic can be selected for the limitation of the return flow temperature.

Examples for adjusting the characteristic:

- ▶ Old building, radiator design 90/70: Gradient approx. 1.8
- ▶ New building, radiator design 70/55: Gradient approx. 1.4
- ▶ New building, radiator design 55/45: Gradient approx. 1.0
- ▶ Underfloor heating depending on installation: Gradient smaller than 0.5

Note!

Particularly for control operation without room sensor, the adjusted room temperatures for day (*Day set point*) and night (*Night set point*) only become effective satisfactorily when the heating characteristic has been adapted to the building/the heating surface layout.

Function	WE	Configuration
Characteristic	0	CO1 -> F04 - 0
Parameters	WE	Rotary switch / Range of values
Day set point	20 °C	10 to 40 °C
Night set point	15 °C	10 to 40 °C
Parameters	WE	Parameter level / Range of values
Gradient, flow	1.8	PA1 / 0.2 to 3.2
Level, flow	0 °C	PA1 / -30 to 30 °C
Min. flow temperature	20 °C	PA1 / 0 °C to max. flow temperature
Max. flow temperature	90 °C	PA1 / Min. flow temperature to 130 °C

5.1.2 4-point characteristic

The 4-point characteristic allows you to define your own heating characteristic. It is defined by 4 points for the *Outdoor temperature*, the *Flow temperature*, the *Reduced flow temperature* and the *Return flow temperature*. The *Set-back difference* at points 2 and 3 indicates the value by which the flow temperature is reduced outside the times-of-use. The parameters *Max. flow temperature* and *Min. flow temperature* mark the upper and lower limits of the flow temperature.

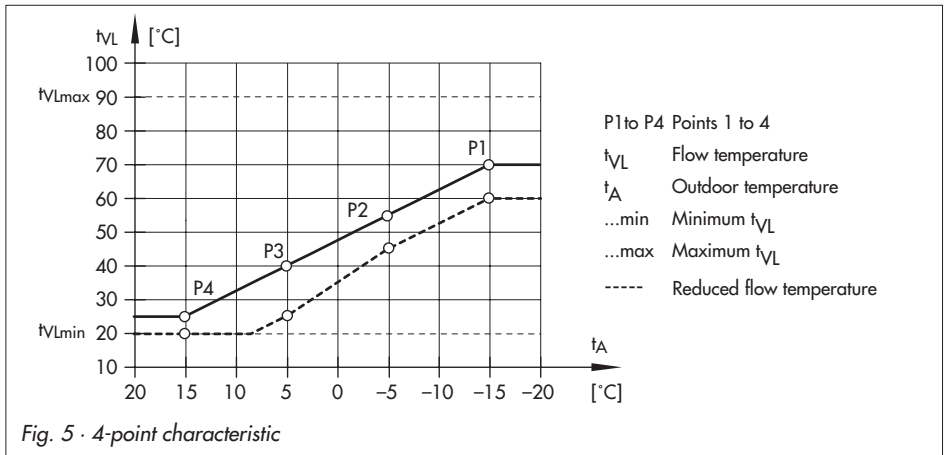

Note!

The parameters Day set point and Night set point are no longer available when the 4-point characteristic has been selected, provided no additional functions (e.g. **Optimization** or **Flash adaptation**) have been selected.

Function	WE	Configuration
Characteristic	0	CO1 -> F04 - 1
Parameters	WE	Parameter level / Range of values
Outdoor temperature	Point 1 Point 2 Point 3 Point 4	-15 °C -5 °C 5 °C 15 °C
		PA1 / -30 to 50 °C

Parameters		WE	Parameter level / Range of values
Flow temperature	Point 1	70 °C	PA1 / 20 to 130 °C
	Point 2	55 °C	
	Point 3	40 °C	
	Point 4	25 °C	
Return flow temp.	Points 1 to 4	65 °C	PA1 / 20 to 90 °C
Set-back difference	Points 2, 3	15 °C	PA1 / 0 to 50 °C
Min. flow temperature		20 °C	PA1 / 0 °C to max. flow temperature
Max. flow temperature		90 °C	PA1 / Min. flow temperature to 130 °C

5.2 Fixed set point control

During the times-of-use, the flow temperature can be controlled according to a fixed set point. Outside the times-of-use, the controller uses the reduced flow temperature. Set the desired rated flow temperature as *Day set point*, and the reduced flow temperature as *Night set point*.

Function	WE	Configuration
Outdoor temperature t_A	1	CO1 -> F07 - 0
Parameters	WE	Rotary switch / Range of values
Day set point	50 °C	0 to 130 °C
Night set point	30 °C	0 to 130 °C

5.3 Drying of jointless floors

The first heating up is performed with a flow temperature of 25 °C. In the course of 24 hours, this temperature is raised by the value entered in *Temperature rise*, i.e. the default setting causes the temperature to rise continuously to 30 °C within the first 24 hours. If the *Maximum temperature* is reached, it is kept constant for the number of days entered in *Maintaining time for maximum temperature*. The *Temperature reduction* parameter determines the downward ramp. If this parameter is set to 0, the maintaining phase runs straight into the automatic mode.

By changing the setting *STOP 0* to *START 1*, the function is activated. The controller permits no further change to the operating parameters of the function.

The course of the drying process can be monitored in the information level over the icon of flow temperature display (☐↓) of the heating circuit:

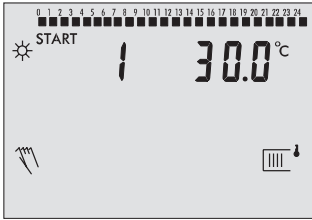

The digit behind START _ indicates in which operating phase the drying of jointless floors is in:

- ▶ 1 = Temperature build-up phase
- ▶ 2 = Temperature maintaining phase
- ▶ 3 = Temperature reducing phase

The drying process has been successfully completed when the additional icon in the flow temperature display goes out

after the last phase without an operating fault appearing. *Err 6* indicates that the flow temperature deviated from the set point by more than 5 °C for longer than 30 minutes which leads to the drying process being canceled. While *Err 6* appears, a flow temperature of 25 °C is used. Any disconnection of the power supply automatically leads to the drying process starting from the beginning again.

Note!

In the information level, an active drying function is indicated by the icon. In system code numbers 2 and 3, storage charging is not performed while the drying of jointless floors is active, provided they do not serve to the frost protection of the storage tank.

After the drying function has been successfully completed, the function block CO1 -> F09 should not be deactivated if you want to trace back with which operating parameters the drying process was carried out.

Function	WE	Configuration
Drying of jointless floors	0	CO1 -> F09 - 1
	5.0 °C/24 h	Temperature rise / 1.0 to 10.0 °C/24 h
	45 °C	Maximum temperature / 25 to 60 °C
	4 days	Maintaining time for maximum temperature / 1 to 10 days
	5.0 °C/24 h	Temperature reduction / 0.0 to 10.0 °C/24 h
	STOP 0	START 1

5.4 Outdoor temperature dependent deactivation

5.4.1 OT deactivation value rated operation

If the outdoor temperature exceeds the limit in *OT deactivation value rated operation*, the heating circuit is put out of service immediately. The valve is closed and the pump is switched off after the adjusted *Lag time of heating circulation pump* has elapsed. When the outdoor

temperature falls below this value (less 0.5 °C hysteresis), heating operation is restarted immediately.

With the default settings, this means that, during the warm season, the system is switched off at an outdoor temperature of 22 °C.

Parameters	WE	Parameter level / Range of values
OT deactivation value rated operation	22 °C	PA1 / 0 to 50 °C
Lag time of heating circulation pump	180 sec	PA1 / 15 to 2400 sec

5.4.2 OT deactivation value reduced operation

If the outdoor temperature exceeds the limit value *OT deactivation value reduced operation* in reduced operation, the heating circuit is put out of service immediately. The valve is closed and the pump is switched off after the adjusted *Lag time of heating circulation pump* has elapsed. When the outdoor temperature falls below this value, heating operation is restarted immediately.

With the default settings, this means that, at night, the system is switched off at an outdoor temperature of 15 °C to save energy. Nevertheless, remember that the system requires some time in the morning to heat up the building (→ Advance heating depending on outdoor temperature, section 5.7.1).

Parameters	WE	Parameter level / Range of values
OT deactivation value reduced operation	15 °C	PA1 / OT activation value rated operation to 50 °C
Lag time of heating circulation pump	180 sec	PA1 / 15 to 2400 sec

5.4.3 OT activation value rated operation

If the heating circuit is in reduced operation (automatic operating mode), the circuit is automatically transferred to rated operation when the outdoor temperature falls below the limit value *OT activation value rated operation*. Reduced operation is restarted when the limit value is exceeded.

This function is activated at very low temperatures to avoid that the building cools down excessively outside the times-of-use when low outdoor temperatures occur.

Parameter	WE	Parameter level / Range of values
OT activation value rated operation	-15 °C	PA1 / -30 °C to OT activation value reduced operation

5.4.4 Summer mode

Summer mode is activated depending on the mean daytime temperature (measured between 7.00 h and 22.00 h) during the desired period.

If the mean daytime temperature exceeds the *OT limit value summer mode* on n successive days, summer mode is activated on the following day. This means that the heating is switched off. If the mean daytime temperature remains below the *OT limit value summer mode* on m successive days, summer mode is deactivated on the following day.

Summer mode only becomes effective when the controller is in automatic mode (☺).

Functions	WE	Configuration
Summer mode	0	CO1 -> F06 - 1
	01.06	Start summer mode / 01.01 to 31.12 (1 Jan to 31 Dec)
	2	No. of days until activation / 1 to 3
	30.09	Stop summer mode / 01.01 to 31.12
	1	No. of days until deactivation / 1 to 3
	18 °C	OT limit value summer mode / 0 to 50 °C
Outdoor temperature t_A	1	CO1 -> F07 - 1

5.5 Delayed outdoor temperature adaptation

The calculated outdoor temperature is used to determine the flow temperature set point. The heat response is delayed when the outdoor temperature either decreases or increases and decreases. If the outdoor temperature varies by, for example, 12 °C within a very short period of time, the calculated outdoor temperature is adapted to the actual outdoor temperature in small steps. Assuming a *Delay* of 3 °C/h, the adaptation would take $t = \frac{12 \text{ °C}}{3 \text{ °C/h}} = 4\text{h}$.

Note!

The delayed outdoor temperature adaptation helps avoid unnecessary overloads of central heating stations in combination with either overheated buildings occurring, for example, due to warm winds, or temporarily insufficient heating due to the outdoor sensor being exposed to direct sunshine. In the info level, the calculated outdoor temperature can be viewed by pressing the rotary switch while the outdoor temperature is displayed.

Functions	WE	Configuration
Delayed outdoor temperature adaptation	0	CO1 -> F05 - 1 (1, 2)
		1 When outdoor temperature t_A decreases 2 When outdoor temp. t_A decreases and increases
	3 °C/h	Delay / 1 to 6 °C/h
Outdoor temperature t_A	1	CO1 -> F07 - 1

5.6 Remote operation

5.6.1 Room panel

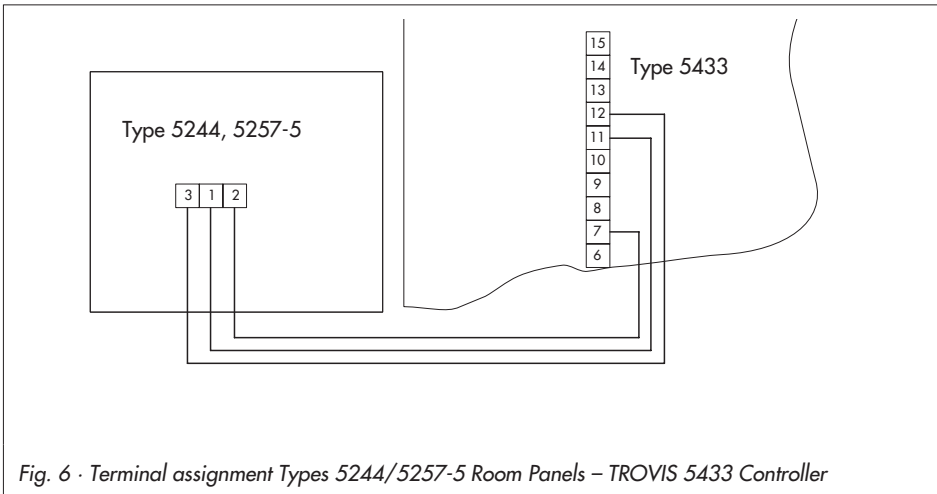

Fig. 6 · Terminal assignment Types 5244/5257-5 Room Panels – TROVIS 5433 Controller

Apart from measuring the room temperature, the Type 5244 Room Panel (PTC sensor) and the Type 5257-5 Room Panel (Pt 1000 sensor) allow you to influence the control process as follows:

- ▶ Selection of the operating mode:
 - Automatic mode
 - Day mode
 - Night mode
- ▶ Set point correction: during rated operation, the room temperature set point can be increased or reduced by up to 5 °C using a continuously adjustable rotary knob.

When the room sensor is activated and the remote room controller (room panel) is connected and activated, the measured room temperature is displayed. Nevertheless, it is not used for control unless the **Optimization** or **Flash adaptation** functions have been activated.

Function	WE	Configuration
Room sensor RS	0	CO1 -> F01 - 1, option: 1

Note!

The Day set point adjusted via the rotary switch remains unaffected by set point corrections performed over the room panel. Only the calculated flow temperature set point or the room temperature set point (for flash adaptation) are adjusted accordingly.

5.6.2 Floating switch

The heating circuit can be switched to night mode by closing the switching contact if a floating switch is connected to input RS.

Function	WE	Configuration
Room sensor RS	0	CO1 -> F01 - 0

5.7 Optimization

5.7.1 Advance heating depending on outdoor temperature

The controller activates rated operation of the heating system before the time-of-use starts depending on the outdoor temperature. The *Advance heating time* refers to an outdoor temperature of -12 °C. In case of higher outdoor temperatures, the advance heating time is reduced.

This means, the colder it is outside, the earlier the night set-back is terminated to ensure that the desired room temperature *Day set point* has been reached at the beginning of the time-of-use, if possible.

Functions	WE	Configuration
Optimization	0	CO1 -> F02 - 1, option: 1 120 min Advance heating time / 0 to 360 min
Outdoor temperature t_A	1	CO1 -> F07 - 1

5.7.2 Optimization with room sensor

The following two functions are only appropriate when the room containing the room sensor (reference room) has a heating characteristic similar to the rest of the building. No thermostatic valves should be mounted on the radiators in the reference room.

Depending on the activation conditions, two optimizing modes are available:

- ▶ **Advance heating depending on outdoor temp., deactivation depending on room temp.**
The controller activates rated operation of the heating system before the time-of-use starts depending on the outdoor temperature. The *Advance heating time* refers to an outdoor temperature of $-12\text{ }^{\circ}\text{C}$. In case of higher outdoor temperatures, the advance heating time is reduced (-> section 5.7.1).
- ▶ **Advance heating and deactivation depending on room temperature**
Depending on the building characteristics, the controller determines and adapts the required advance heating time (max. 6 hours) to ensure that the desired *Day set point* (rated room temperature) has been reached in the reference room when the time-of-use starts. During the advance heating period, the controller heats with the max. flow temperature. As soon as the *Day set point* has been reached, weather-compensated control is activated.

Depending on the room sensor, the controller switches off the heating system up to 2 hours before the time-of-use ends. The controller chooses the deactivation time such that the room temperature does not drop significantly below the desired value until the time-of-use ends. During the advance heating period and the premature deactivation of the heating system, the icons ☀ or ☾ blink on the display. Outside the times-of-use, the controller monitors the *Night set point* (reduced room temperature). When the temperature falls below the night set point, the controller heats with the max. flow temperature until the measured room temperature exceeds the adjusted value by $1\text{ }^{\circ}\text{C}$.

Note!

Direct sunshine can cause the room temperature to increase and thus result in the premature deactivation of the heating system.

When the room temperature decreases while the heating system is temporarily outside its times-of-use, this can prematurely cause the controller to heat up to the adjusted Day set point.

Functions	WE	Configuration
Room sensor RS	0	CO1 -> F01 - 1, option: 1

Activation depending on outdoor temperature, deactivation depending on room temperature:

Optimization	0	CO1 -> F02 - 1, option: 2 120 min Advance heating time / 0 to 360 min
Outdoor temperature t_A	1	CO1 -> F07 - 1

Activation and deactivation depending on room temperature:

Optimization	0	CO1 -> F02 - 1, option: 3
Parameters	WE	Rotary switch / value range
Day set point	20 °C	10 to 40 °C
Night set point	15 °C	10 to 40 °C

5.8 Flash adaptation

To achieve that the controller reacts immediately to room temperature deviations, set the function block setting CO1 -> F03 - 1.

Flash adaptation counteracts room temperature deviations by increasing or decreasing the flow temperature by up to 30 °C. The *Cycle time* determines the intervals at which the flow temperature set point is corrected by 1 °C.

Note!

*Cooling loads, such as drafts or open windows, affect the control process!
Rooms may be temporarily overheated when the cooling load has been eliminated!*

Functions	WE	Configuration
Room sensor RS	0	CO1 -> F01 - 1, option: 1
Flash adaptation	0	CO1 -> F03 - 1 10 min Cycle time / 1 to 100 min

5.9 Room temperature dependent control

A Type 5244 or Type 5257-5 Room Panel needs to be connected for the **room temperature dependent control** function; this control functions, however, without using an outdoor sensor. The flow temperature is raised or reduced by up to 30 °C when room temperature deviations occur. The cycle time determines the time between the correction of the flow temperature set point by 1 °C. The flow temperature control starts with 50 °C as the set point, and 30 °C in reduced operation, provided the *Maximum flow temperature (PA1)* permits it.

Functions of the heating circuit

In rated operation, the heating is switched off when the room temperature exceeds the *Day set point* by 2 °C. In reduced operation, the heating is switched off when the room temperature exceeds the *Night set point* by 2 °C.

Note!

We recommend not to select a cycle time that is too short. Cycle times that are too short have a negative effect especially in case of cooling loads, such as drafts or open windows, that affect the control process. Rooms may be temporarily overheated when the cooling load has been eliminated!

Functions	WE	Configuration
Room sensor RS	0	CO1 -> F01 - 1, option: 1
Flash adaptation	0	CO1 -> F03 - 1
	10 min	Cycle time / 1 to 100 min
Outdoor temperature t_A	1	CO1 -> F07 - 0

6 Functions of the DHW circuit

6.1 DHW heating in the storage tank system

Start storage tank charging

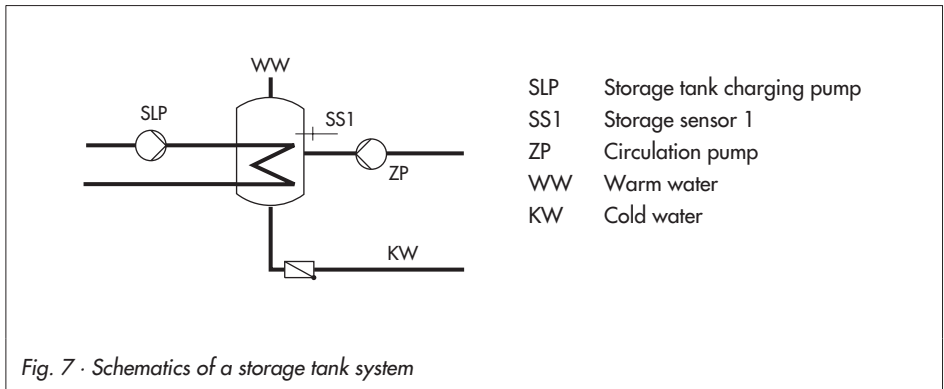



Fig. 7 · Schematics of a storage tank system

The controller begins charging the storage tank when the water temperature measured at sensor SS1 falls below the *DHW temperature set point* by 0.1 °C. If the flow temperature in the system deviates from the optimum charging temperature by more than 5 °C, the controller tries to adapt the flow temperature in the heating circuit for up to 3 minutes before the storage tank charging pump is activated. During these operating periods, the  icon blinks. When no heating operation takes place, the storage tank charging pump is switched on immediately.

If the function CO2 -> F08 - 1 (**SLP ON depending on return flow temperature**) is activated, the primary valve is opened without simultaneously operating the storage tank charging pump. The storage tank charging pump is not switched on before the primary return flow temperature has reached the temperature currently measured at storage sensor SS1, yet after five minutes at the latest.

This function enables storage tank charging when the heating system is switched off, e.g. in summer mode, without cooling down the storage tank first by filling it with cold flow water. The storage tank charging pump does not start operation before a sufficiently high temperature has been reached at the heat exchanger.

If times-of-use have been set for DHW heating, the *DHW temperature set point* adjusted at the rotary switch is valid during these times-of-use.

Outside the times-of-use, the *Sustained DHW temperature* parameter is used. This does not apply when a storage tank thermostat is used.

Note!

Instead of the DHW temperature parameter, the Charging temperature can be set as the absolute value at the rotary switch if a storage tank thermostat is used.

Stop storage tank charging

The controller stops charging the storage tank when the water temperature measured at sensor SS1 has reached the temperature $T = \text{DHW temperature} + \text{hysteresis}$.

When there is no heating operation or when the flow temperature demand in the system is lower, the corresponding valve is closed.

The storage tank charging pump is switched off when the limit temperature for *Stop charging* has been reached, at the latest, however, after approx. 3 minutes.

The default setting of this function causes the storage tank to be charged by 5 °C to 60 °C when the storage tank temperature falls below 55 °C. The charging temperature is calculated from the DHW temperature (55 °C) plus the charging temperature boost (10 °C), which equals 65 °C. When the storage tank has been charged, the heating valve is closed and the charging pump continues operation until the charging temperature falls below 53 °C. Outside the times-of-use, the storage tank is only charged when the temperature falls below 40 °C (*Sustained DHW temperature*). In this case, the tank is charged with a charging temperature of 50 °C until 45 °C are reached in the tank.

Functions	WE	Configuration
Storage sensor SS1	1	CO2 -> F01 - 1
Parameter	WE	Rotary switch / Range of values
DHW temperature set point	55 °C	Min. to max. DHW temperature
Parameters	WE	Parameter level / Range of values
Min. DHW temperature*	40 °C	PA2 / 20 to 90 °C
Max. DHW temperature*	60 °C	PA2 / 20 to 90 °C
Hysteresis**	5 °C	PA2 / 0 to 30 °C
Charging temperature boost***	10 °C	PA2 / 0 to 30 °C
Stop charging	53 °C	PA2 / 20 to 90 °C
Sustained DHW temperature	40 °C	PA2 / 20 to 90 °C

* Parameters serve as limitation of the adjustment range for the DHW temperature to be set at the rotary switch

** Deactivation value $T = \text{DHW temperature} + \text{hysteresis}$

*** Charging temperature $T = \text{DHW temperature} + \text{charging temperature boost}$

6.2 DHW heating in the storage tank charging system

Start storage tank charging

The controller begins charging the storage tank when the water temperature measured at sensor SS1 falls below the *DHW temperature set point* by 0.1 °C. If the flow temperature in the system exceeds the desired charging temperature, the controller tries to reduce the flow temperature in the heating circuit for up to 3 minutes before the exchanger charging pump is activated together with the storage tank charging pump.

When there is no heating operation or when the flow temperature in the system is lower, the exchanger charging pump is switched on immediately. If the temperature currently measured at sensor SS1 is reached at sensor VS, the storage tank charging pump is switched on. A blinking  icon during such operating periods indicates active charging preparations. If a storage tank thermostat is used, the storage tank charging pump is switched on when the temperature $T = \text{charging temperature} - 5\text{ °C}$ is reached at sensor VS.

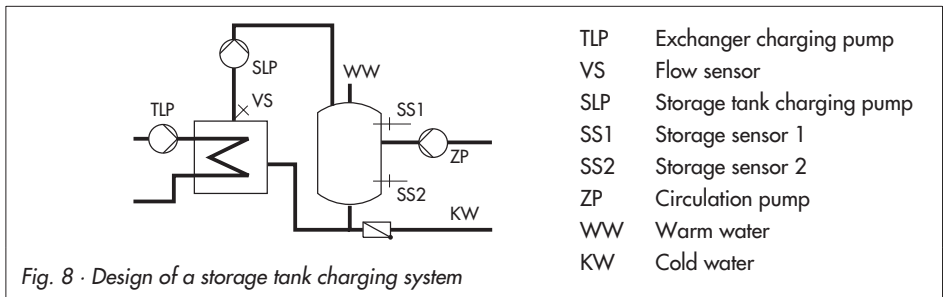

Note!

Instead of the DHW temperature parameter, the Charging temperature can be set as the absolute value at the rotary switch if a storage tank thermostat is used.

When the flow sensor VS2 is activated, control is switched from VS1 to VS2 upon activation of the storage tank charging pump. The set point reading of the charging temperature also changes from this point in time from VS1 to VS2. The *Maximum charging temperature* can be read off at the measured value VS1.

Due to the transfer performance of the heat exchanger, which may deteriorate over the operating time, the flow temperature at VS1 tends to increase in level. When it reaches the parameter value *Max. charging temperature* in the heat exchanger circuit, the flow temperature remains limited to this level; Alarm "Err 4" is generated. The alarm can be confirmed by pressing the rotary pushbutton in the error level.

If times-of-times have been set for DHW heating, the *Set point DHW temperature* adjusted at the rotary switch is applied during these times-of-use.

Outside the times-of-use, the *Sustained DHW temperature* parameter is used. This does not apply when a storage tank thermostat is used.

Stop storage tank charging

The controller stops charging the storage tank when the temperature measured at sensor SS2 has reached the value $T = \text{DHW temperature} + \text{hysteresis}$.

When there is no heating operation or when the flow temperature demand in the system is lower, the valve is closed.

The exchanger charging pump is switched off when the limit temperature for *Stop charging* has been reached, at the latest, however, after approx. 3 minutes; with a certain delay, the storage tank charging pump is deactivated as well. When flow sensor VS2 is activated, the storage tank charging pump is switched off with a certain delay when the limit temperature *Storage tank charging pump OFF* has been reached, at the latest, however, after approx. 3 minutes.

In system Anl 6, it is also possible to link the circulation pipe into the heat exchanger (dashed line in the schematics). In this case, the regulation of the charging temperature and the operation of the heat exchanger charging pump remain active even outside the heat exchanger charging times depending on the times-of-use of the circulation pump.

Functions	WE	Configuration
Storage sensor SS1	1	CO2 -> F01 - 1
Storage sensor SS2	1	CO2 -> F02 - 1
Flow sensor VS2	0	CO2 -> F03
Parameter	WE	Rotary switch / Range of values
DHW temperature set point	55 °C	Min. to max. DHW temperature
Parameters	WE	Parameter level / Range of values
Min. DHW temperature*	40 °C	PA2 / 20 to 90 °C
Max. DHW temperature*	60 °C	PA2 / 20 to 90 °C
Hysteresis**	5 °C	PA2 / 0 to 30 °C
Charging temperature boost***	10 °C	PA2 / 0 to 30 °C
Stop charging	53 °C	PA2 / 20 to 90 °C
Storage tank charging pump OFF	53 °C	PA2 / 20 to 90 °C (only Anl 3 with VS2)
Max. charging temperature	80 °C	PA2 / 20 to 120 °C (only Anl 3 with VS2)
Sustained DHW temperature	40 °C	PA2 / 20 to 90 °C

* Parameters serve as limitation of the adjustment range for the DHW temp. to be set at the rotary switch

** Deactivation value $T = DHW\ temperature + hysteresis$

*** Charging temperature $T = DHW\ temperature + charging\ temperature\ boost$

6.3 DHW heating in the instantaneous water system

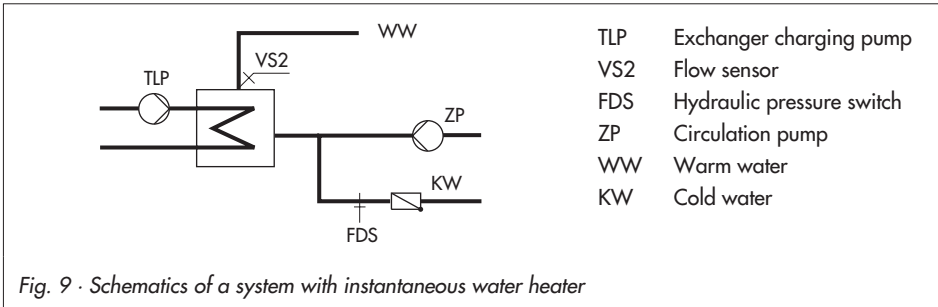

DHW heating in a system with an instantaneous water heater can be configured using system Anl 5.

A hydraulic pressure switch signals the controller the beginning and end of DHW tapping. When the pressure switch makes contact, the exchanger charging pump starts operation and DHW temperature control at sensor VS2 is activated.

When the contact is open, the control valve shuts off the DHW circuit. The exchanger charging pump is deactivated with a certain delay.

Note!

Control of the exchanger charging pump is only possible if the **Fault alarm output BA** function has been deactivated.

Functions	WE	Configuration
Instantaneous heating system with hydraulic pressure switch	0	CO2 -> F14 - 1
	2.0	K_p (proportional gain) / 0.1 to 50.0
	120 sec	T_N (reset time) / 0 to 999 sec
	0 sec	d component / 0 to 999 sec
	1.0	$K_p T_V$ (d component of the proportional gain) / 0.1 to 10.0
	45 sec	T_Y (valve transit time) / 10 to 240 sec
Fault alarm output BA	1	CO-SYS -> F13 - 0
Parameter	WE	Rotary switch / Range of values
DHW temperature set point	55 °C	Min. to max. DHW temperature

6.4 Intermediate heating operation

This function is only available in systems Anl 2 and 3. With the setting CO2 -> F10 - 1, heating operation is reactivated for 10 minutes after 20 minutes of priority (heating deactivated during DHW heating). By setting CO2 -> F10 - 0, storage tank charging is given unlimited priority over heating operation.

Functions	WE	Configuration
Parallel pump operation	0	CO2 -> F06 - 0
Intermediate heating	1	CO2 -> F10 - 1

6.5 Parallel pump operation

This function is only available in Anl 2 and 3. With the setting CO2 -> F06 - 1, the circulation pump UP remains switched on during DHW heating unless certain operating situations occur. The operating situations that do not apply include those in which the actual set point for the heating circuit is less than 40 °C or in which the *Max. flow temperature* would be exceeded. In these cases, the controller applies priority operation. Once a parallel pump operation cycle has been activated and the time for *Stop parallel operation in case of deviation* has elapsed, system deviations greater than 5 °C cause the controller to suspend parallel operation for 10 minutes and to apply priority operation.

If the *Stop parallel operation in case of deviation* is set to ---, the parallel operation remains active regardless of any deviations.

Functions	WE	Configuration
Parallel pump operation	0	CO2 -> F06 - 1, option: 1
	600 sec	Stop parallel operation in case of deviation / ---, 60 to 600 sec
Intermediate heating	1	CO2 -> F10 - 0

6.6 Operation of circulation pump during storage tank charging

This function is only available in Anl 2, 3, 4 and 6. With the setting CO2 -> F04 - 1, the circulation pump continues operation according to the set schedule even during storage tank charging. With the setting CO2 -> F04 - 0, the circulation pump is switched off as soon as the storage tank charging pump is activated. The circulation pump returns to operate according to schedule when the storage tank charging pump has been switched off again.

Function	WE	Configuration
Operation of circulation pump during storage tank charging	0	CO2 -> F04

6.7 Priority operation

In many district heating systems with primary DHW heating, the allotted amount of water is only intended to supply the heating system. As a result, the capacity required for DHW heating needs to be taken from the heating system when great heating loads occur; and this, until DHW heating has been concluded.

Nevertheless, heating operation is not to be interrupted simply. Only the amount of energy required for DHW heating is to be deducted. This can be achieved by using the priority functions **Reverse control** and **Set-back operation**.

6.7.1 Reverse control

In systems Anl 4 and 5, DHW heating can be given priority by applying reverse control. With the setting CO2 -> F09 - 1, option 1 allows the temperature at VS2 is monitored. If the temperature at VS2 is still 5 °C lower than *Monitoring value* after the time for *Activate priority in case of deviation* has elapsed, the set point of the heating circuit is gradually reduced each minute until the flow temperature set point has reached 20 °C at the minimum provided the *DHW temperature set point* has still not been reached.

If the temperature at VS2 rises above *Monitoring value* minus 5 °C, the reduced flow temperature set point in the heating circuit is initially kept. First when the temperature at VS2 is greater than the *Monitoring value*, the flow temperature set point of the heating circuit is gradually raised each minute.

Function	WE	Configuration
Priority through reverse control	0	CO2 -> F09 - 1, option: 1
	300 sec	Activate priority in case of deviation / 60 to 600 sec
	40 °C	Monitoring value / 20 to 90 °C

6.7.2 Set-back operation

In systems Anl 4 and 5, DHW heating can be given priority by applying set-back operation. With the setting CO2 -> F09 - 1, option 2 allows the temperature at VS2 is monitored. If the temperature at VS2 is still lower than *Monitoring value* minus 5 °C after the time for *Activate priority in case of deviation* has elapsed, the heating circuit is set to reduced operating mode or reduced by a corresponding amount in case the heating circuit was already in reduced operating mode. First when the temperature at VS2 is greater than the *Monitoring value*, the

reduced operating mode stops after the time for *Activate priority in case of deviation* has elapsed.

Function	WE	Configuration
Priority through set-back operation	0	CO2 -> F09 - 1, option: 2
	300 sec	Activate priority in case of deviation / 60 to 600 sec
	40 °C	Monitoring value / 20 to 90 °C

6.8 Forced charging of the DHW storage tank

To provide the full room heating performance when the time-of-use of the heating circuits begins, existing storage tanks are charged one hour before the time-of-use of the heating circuits starts. For the individual controller, this means that storage tank charging is activated when the water temperature in the storage tank falls below the adjusted deactivation value of $T = \text{DHW temperature} + \text{hysteresis}$. The forced charging of the storage tank does not occur when the DHW circuit is not used at the beginning of the time-of-use set for the heating circuit.

Note! This function is not available when a storage tank thermostat is used.

6.9 Thermal disinfection of the DHW storage tank

In all systems with DHW storage tank, the DHW storage tank is thermally disinfected on a selected *Day of the week* or every day.

The tank is heated up to the adjusted *Disinfection temperature*, taking into account the *Charging temperature boost*. Disinfection begins at the adjusted *Start time* and, at the latest, ends at the specified *Stop time* set in CO2 -> F20 - 0. In case of the **Time-controlled thermal disinfection** (CO2 -> F20 - 1), the disinfection remains active even after the *Disinfection temperature* is reached and ends at the adjusted *Stop time*.

In addition to this function or instead of it, the thermal disinfection can be activated by a **binary input**. The binary input, which initiates the thermal disinfection process, functions either as a momentary-action switch or a latching-action switch:

- ▶ Functioning as a momentary-action switch, the floating switch at input RS leads to the next programmed thermal disinfection running right through from the *Start time* to the *Stop time*.
- ▶ Functioning as a latching-action switch, a closed contact of the floating switch at input RS leads to the thermal disinfection being active until the contact is opened again.

☞ blinks while the thermal disinfection is active.

If the *Disinfection temperature* has not been reached in the tank and, when a circulation sensor ZS (in Anl 6 only) is used, at this sensor as well before the end of the thermal disinfection cycle, "Err 3" alarm is generated. The alarm is automatically reset when the *Disinfection temperature* is properly reached during the following thermal disinfection cycle. The alarm can be confirmed by pressing the rotary pushbutton in error level.

If required, the controller can indicate an active thermal disinfection using an activated binary output BA. If this function is active, the collective alarm and boiler demand functions, which use the same binary output, are automatically deactivated.

Thermal disinfection for preventing legionella infection causes

- ▶ excessively high return flow temperatures during the disinfection cycle (return flow temperature limitation suspended),
- ▶ excessively high storage temperatures after thermal disinfection has been concluded,
- ▶ lime precipitation, which may have a negative effect on heat exchanger performance.

Note! This function is not available when a storage tank thermostat is used.

Function	WE	Configuration
Thermal disinfection	0	CO2 -> F05 - 1
	3	Day of the disinfection / 0, 1, 2, ..., 7, with 0 = daily, 1 = Monday, 2 = Tuesday, ..., 7 = Sunday
	0:00 h	Start time / 0:00 h to 23:30 h
	4:00 h	Stop time / 0:00 h to 23:30 h
	70 °C	Disinfection temperature / 60 to 90 °C
Circulation sensor ZS	0	CO2 -> F17 - 1
Thermal disinfection over a binary input	0	CO2 -> F19 - 1
		Function block parameters only when CO2 -> F05 - 0:
	0:00 h	Start time / 0:00 h to 23:30 h
	4:00 h	Stop time / 0:00 h to 23:30 h
	70 °C	Disinfection temperature / 60 to 90 °C
Time-controlled disinfection	0	CO2 -> F20 - 1
Binary output BA activated during thermal disinfection	0	CO-SYS -> F16 - 1

6.10 Vacation periods and public holidays for DHW heating

With the default settings, the adjusted public holidays and vacation periods are only valid for the heating circuit. The times-of-use set for Sunday for the DHW circulation pump and for DHW heating can also be applied on public holidays, provided the **Vacations and holidays also valid for DHW** function has been activated. This function also deactivates DHW heating during the adjusted vacation periods (frost protection).

Function	WE	Configuration
Vacations and holidays also valid for DHW	0	CO2 -> F07 - 1

7 System-wide functions

7.1 Automatic summer time/winter time changeover

The clock is automatically adjusted on the last Sunday in March at 2.00 h and on the last Sunday in October at 3.00 h.

Function	WE	Configuration
Summer time/winter time changeover	1	CO-SYS -> F03 - 1

7.2 Frost protection

The heating system is automatically monitored for frost.

The following activation criteria and frost protection measures apply:

Activation criteria	Frost protection measures
Heating operation is active and the outdoor temperature falls below 3 °C.	None
Heating operation is either switched off at the operating modes switch (☉, ☞) or suspended in optimizing mode and the outdoor temperature falls below 3 °C.	Controlled to a flow temperature set point of 20 °C. Heating circulation pump and circulation pump are switched on.
In weather-compensated or room temperature dependent flow temperature control (not fixed set point control), the flow temperature falls below 5 °C.	Controlled to a flow temperature set point of 20 °C for 5 minutes.
DHW temperature falls below 5 °C.	DHW storage tank is charged. In the instantaneous system, a DHW temperature of 10 °C is maintained.

Note! Frost-protection-induced operation of a pump, the heating circuit or the DHW circuit only applies when the frost protection icon  appears on the display.

7.3 Forced operation of the pumps

When the heating circuit pump has not been activated for 24 hours, forced operation of the pump is started between 12.00 h and 12.01 h to prevent the pump from getting stuck when it is not operated for a longer period of time.

The other pumps are operated between 12.01 h and 12.02 h.

7.4 Return flow temperature limitation

The temperature difference between the flow and return flow in a system indicates how well the energy is used: the greater the difference, the higher the efficiency. A return flow sensor is sufficient to evaluate the temperature difference when the flow temperatures are preset. The return flow temperature can be limited either to a value depending on the outdoor temperature (variable) or to a fixed value. When the temperature measured at return flow sensor RüS exceeds the limit value, the set point of the flow temperature (flow temperature of the heating system, charging temperature) is reduced. As a result, the primary flow rate is reduced and the return flow temperature falls. The *Limiting factor* determines how strongly the controller responds when the limit values are exceeded in either direction. The values of the actual return flow temperature and of the set point (flow temperature of the heating system, charging temperature) blink on the display when limitation is applied. In Anl 2 and 3 the *Max. return flow temperature* parameter (PA2 level) is used for limitation. In Anl 5 with separate RüS_TW, the *Max. return flow temperature* parameter (PA2 level) only affects the DHW circuit.

Note!

Using weather-compensated control with gradient characteristic, the return flow temperature is limited to a fixed value by equating the parameters Return flow temperature foot and Max. return flow temperature (PA1).

Functions	WE	Configuration
Return flow sensor RüS	1	CO-SYS -> F01 - 1*
Return flow sensor RüS_TW	1	CO2 -> F12 - 1* (Anl 5)
Control mode DHW	1	CO2 -> F11 - 1 (Anl 5)
Instantaneous heating system with hydraulic pressure switch	0	CO2 -> F14 - 0 (Anl 5)
	1.0	*Limiting factor / 0.1 to 10.0
Parameters	WE	Parameter level / Range of values
Gradient, return flow	1.2	PA1 / 0.2 to 3.2
Level, return flow	0 °C	PA1 / -30 to 30 °C
Return flow temperature foot	65 °C	PA1 / 20 to 90 °C
Max. return flow temperature	65 °C	PA1 / 20 to 90 °C

or

System-wide functions

Parameters	WE	Parameter level / Range of values
Return flow temp. points 1 to 4	65 °C	PA1 / 20 to 90 °C
Max. return flow temperature	65 °C	PA2 / 20 to 90 °C

Note!

To ensure that the preset return flow temperature limiting value can be met, make sure that

- the heating characteristic has not been adjusted to ascent too steeply,
- the circulation pumps have not been adjusted to run at excessive speed,
- the heating systems have been calibrated.

7.5 Condensate accumulation control

Activate the **Limit deviation for OPEN signal** function to start up condensate accumulation control plants, in particular to avoid problematic excess temperatures. The controller response to set point deviations that cause the primary valve to open is attenuated. The controller response to set point deviations that cause the control valve to close remains unaffected.

Function	WE	Configuration
Limit deviation for OPEN signal	0	CO-SYS -> F06 - 1
	2 °C	Max. deviation / 2 to 10 °C

In system Anl 5, the **Limit deviation for OPEN signal** function can be separately selected for the DHW circuit.

Function	WE	Configuration
Limit deviation for OPEN signal (DHW circuit)	0	CO2 -> F15 - 1
	2 °C	Max. deviation / 2 to 10 °C

Note!

The condensate accumulation control function can only be activated when no on/off control has been configured (CO-SYS -> F05 - 1 or CO2 -> F11 - 1).

7.6 Three-step control

The flow temperature can be controlled using a PI algorithm. The valve reacts to pulses that the controller emits upon an existing system deviation. The length of the first pulse, in particular, depends on the extent of the system deviation and the selected *Proportional gain* K_P (the pulse length increases as K_P increases). The pulse and pause lengths change continuously until the system deviation has been eliminated.

The pause length between the single pulses is greatly influenced by the *Reset time* T_N (the pause length increases as T_N increases). The *Valve transit time* T_Y specifies the time required by the valve to travel through the range of 0 to 100 %.

In system Anl 5, two control valves are controlled. Consequently, the control mode needs to be set for the DHW circuit as well.

Functions	WE	Configuration
Control mode	1	CO-SYS -> F05 - 1
	2.0	K_P (proportional gain) / 0.1 to 50.0
	120 sec	T_N (reset time) / 0 to 999 sec
	45 sec	T_Y (valve transit time) / 10 to 240 sec
Control mode DHW	1	CO2 -> F11 - 1
	2.0	K_P (proportional gain) / 0.1 to 50.0
	120 sec	T_N (reset time) / 0 to 999 sec
	45 sec	T_Y (valve transit time) / 10 to 240 sec

7.7 On/off control

The flow temperature can be controlled, for example, by activating and deactivating a boiler. The controller switches on the boiler when the flow temperature falls below the set point by $T = 0.5 \times \text{hysteresis}$. When the set point is exceeded by $T = 0.5 \times \text{hysteresis}$, the boiler is switched off again. The greater the value you choose for *Hysteresis*, the lower will be the activation/deactivation frequency. By setting the *Minimum ON time*, an activated boiler remains switched on during this period regardless of the flow temperature fluctuations. Similarly, a deactivated boiler will remain switched off regardless of the flow temperature fluctuations if the *Min. OFF time* has been specified.

Functions	WE	Configuration
Control mode	1	CO-SYS -> F05 - 0
	5 °C	Hysteresis / 2 to 10 °C
	120 sec	Min. ON time / 0 to 600 sec
	120 sec	Min. OFF time / 0 to 600 sec

Functions	WE	Configuration
Control mode DHW	1	CO2 -> F11 - 0
	5 °C	Hysteresis / 2 to 10 °C
	120 sec	Min. ON time / 0 to 600 sec
	120 sec	Min. OFF time / 0 to 600 sec

7.8 Requesting/processing external demand

Requesting external demand

In more complex heating systems, the flow temperature set points can be forwarded from controller to controller. The external flow set point of the previous controller is read over analog input UE and compared to the controller's own flow set point. The higher of the two flow set points is forwarded to the next controller over output UA. On forwarding to other systems, it may be necessary to change the transmission range of the 0-10 V signal. Any changes in transmission range only apply to the analog output UA. The assignment 0 to 10 V = 0 to 120 °C still applies to the analog input UE.

In systems with storage tank thermostat, the *Requested value* parameter can be changed as required. It determines the minimum value of the output signal to UA when the storage tank charging is active.

In systems with storage tank sensors, the *Requested value* is calculated from the current set point of the storage tank (*DHW temperature set point*, *Sustained DHW temperature* or *Disinfection temperature*) plus *Charging temperature boost* plus *Boost* (alternative function block parameter to *Requested value*).

Functions	WE	Configuration
External demand, request	0	CO-SYS -> F10 - 1
	0 °C	Transmission lower range value / 0 to 130 °C
	120 °C	Transmission upper range value / 0 to 130 °C
	70 °C	Requested value / 20 to 90 °C (Anl 4, 5 and 6 only)
	0	Boost / 0 to 30 °C (alternative)
External demand, processing	0	CO-SYS -> F11 - 0
Forward outdoor temperature, 0 to 10 V	0	CO-SYS -> F12 - 0

Furthermore, the binary output BA in the systems Anl 1, 4 and 6 can configure for floating boiler demand:

Function	WE	Configuration
Fault alarm output BA	1	CO-SYS -> F13 - 0

Processing external demand

The controller (= primary controller) can process analog requests for an externally required signal, provided the analog request can be matched to "0 to 10 V correspond with 0 to 120 °C flow temperature". The highest flow set point of the subsequent controller (= secondary controller) is read over analog input UE and compared to the controller's own flow set point. The higher of the two flow set points plus the value of the *Boost* parameter is adjusted (at least 20 °C flow temperature from 1 V input signal).

The *Boost* parameter improves the control response of the subsequent control valves in the heating circuit and compensates for performance losses.

Note!

The adjustment of an external demand is indicated by displaying the \div icon in info level.

The primary controller can be configured to operate with or without outdoor sensor:

► Primary controller with outdoor sensor:

As illustrated in Fig. 10, the primary controller can supply its measured outdoor temperature value at output UA (0 to 10 V); 0 to 10 V = -40 to 50 °C outdoor temperature applies. The secondary controller reads the outdoor temperature over input UE and uses this value to determine its flow temperature set point.

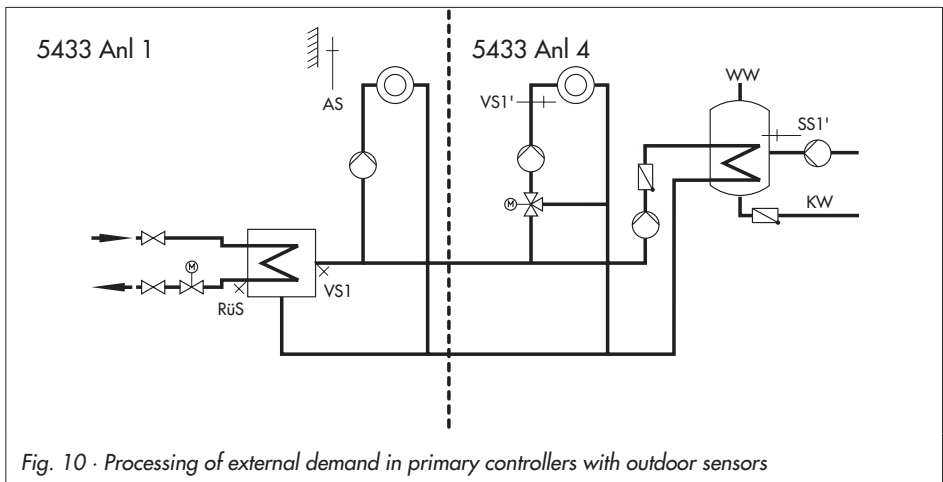

Fig. 10 · Processing of external demand in primary controllers with outdoor sensors

Primary controller:

Functions	WE	Configuration
Outdoor temperature t_A	1	CO1 -> F07 - 1
Outdoor temperature 0 to 10 V at input UE	0	CO1 -> F08 - 0
External demand, request	0	CO-SYS -> F10 - 0
External demand, processing	0	CO-SYS -> F11 - 1
	0 °C	Boost / 0 to 30 °C
Forward outdoor temperature, 0 to 10 V	0	CO-SYS -> F12 - 1

Secondary controller:

Functions	WE	Configuration
Outdoor temperature t_A	1	CO1 -> F07 - 1
Outdoor temperature 0 to 10 V at input UE	0	CO1 -> F08 - 1
External demand, request	0	CO-SYS -> F10 - 1
	70 °C	Requested value / 20 to 90 °C
External demand, processing	0	CO-SYS -> F11 - 0

Primary controller without outdoor sensor:

The controller is configured for demand-driven heat exchanger control with control of the feeder pump. Operation of the feeder pump and heat exchanger control are exclusively released by the received demand signal, not over a time schedule. Demand signals between 1 V and 10 V activate the feeder pump and cause the requested flow temperature (at least 20 °C to 120 °C) plus the adjusted *Boost* to be adjusted. Demand signals below 1 V are not processed; they cause the primary valve to be closed and deactivate the feeder pump with a certain delay. The deactivation delay for the feeder pump can be adjusted.

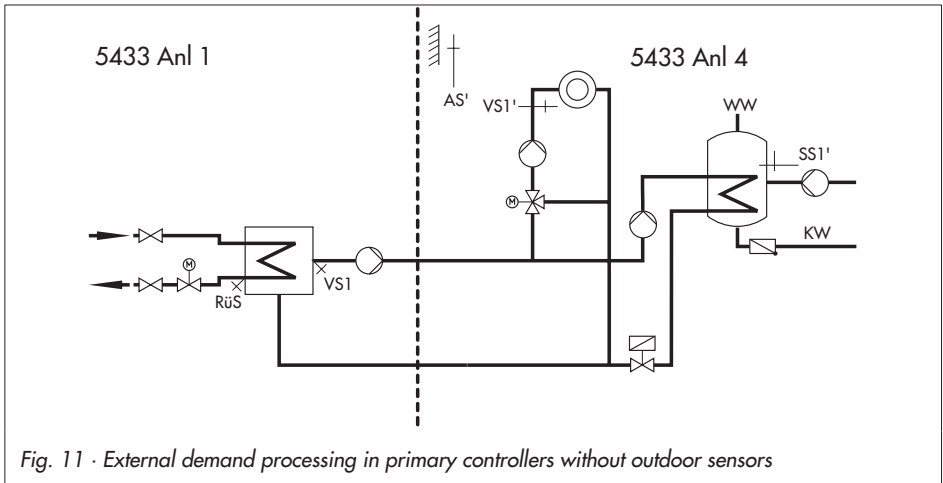

Primary controller:

Functions	WE	Configuration
Outdoor temperature t_A	1	CO1 -> F07 - 0
External demand, request	0	CO-SYS -> F10 - 0
External demand, processing	0	CO-SYS -> F11 - 1
	0 °C	Boost / 0 to 30 °C
Forward outdoor temperature, 0 to 10 V	0	CO-SYS -> F12 - 0
Parameter	WE	Parameter level / Range of values
Lag time of heating circulation pump	180 sec	PA1 / 15 to 2400 sec

Secondary controller:

Functions	WE	Configuration
Outdoor temperature t_A	1	CO1 -> F07 - 1
Outdoor temperature 0 to 10 V at input UE	0	CO1 -> F08 - 0
External demand, request	0	CO-SYS -> F10 - 1
	70 °C	Requested value / 20 to 90 °C
External demand, processing	0	CO-SYS -> F11 - 0

7.9 Locking the manual level

To protect the heating system, this function can be used to lock the manual level. When this function has been activated, automatic mode is started when the rotary switch is set to manual operating mode (- 0 +).

Function	WE	Configuration
Locking the manual level	0	CO-SYS -> F04 - 1

7.10 Locking the rotary switches

When this function has been activated, the controller remains in automatic mode regardless of the rotary switch positions that have been adjusted. The rotary switch "Configuration and parameterization" can only be used to switch between "COPA"- (key number required) and "INFO" level.

Function	WE	Configuration
Locking the rotary switches	0	CO-SYS -> F15 - 1

8 Operational faults

Malfunctions or faults are indicated by the blinking ! icon on the display. In addition, the “Err” alarm is displayed immediately. Press the rotary pushbutton to open error level. It may be possible to view several alarms by turning the rotary pushbutton. As long as an error alarm is present, error level is displayed, even though it has not been opened by pressing the rotary pushbutton.

In error level, the error alarm is displayed as specified in the list below.

8.1 Error alarm list

- ▶ Err 0 = Hardware error (rotary switch position not identified; EEPROM faulty)
- ▶ Err 1 = Sensor failure (-> section 8.2)
- ▶ Err 2 = Reset to default values (after automatic cold start with default values in Anl 1)
- ▶ Err 3 = Disinfection temperature not reached (-> section 6.9; confirmation over rotary pushbutton)
- ▶ Err 4 = Max. charging temperature reached (-> section 6.2; confirmation over rotary pushbutton)
- ▶ Err 5 = Device not calibrated (confirmation over rotary pushbutton)
- ▶ Err 6 = Temperature monitoring (-> section 8.3; confirmation over rotary pushbutton)
/drying of jointless floor cancelation

8.2 Sensor failure

According to the error list, sensor failures are indicated by displaying “Err 1” in error level. For detailed information, exit error level and view the different temperature values in info level: each sensor icon displayed together with \square (= sensor short-circuited) or $||$ (= sensor interrupted) instead of the measured value indicates a defective sensor. The following list explains how the controller responds to the failure of the different sensors.

- ▶ **Outdoor sensor AS:** When the outdoor sensor fails, the controller adjusts a flow temperature set point of 50 °C or the *Max. flow temperature* when the *Max. flow temperature* (adjusted under PA1) is smaller than 50 °C.
- ▶ **Flow sensor VS1:** When the flow sensor in the heating circuit fails, the associated valve moves to 30 % travel. DHW heating using such a sensor to measure the charging temperature is suspended.

- ▶ **Flow sensor in the DWH circuit VS2:** When the sensor VS2 in Anl 3 fails, the flow temperature set point for DHW heating is only controlled with VS1.
In Anl 4, DHW heating is no longer given priority.
In Anl 5, the DHW is no longer heated.
- ▶ **Return flow sensor RÜS_TW:** When the return flow sensor fails, the controller continues operation without return flow temperature limitation.
- ▶ **Room sensor RS:** When the room sensor fails, the controller uses the settings for operation without room sensor. The controller, for example, switches from optimizing mode to reduced operation.
- ▶ **Storage sensors SS1/2:** When one of the two sensors fails, the storage tank is no longer charged.
- ▶ **Circulation sensor ZS:** When the sensor ZS fails, the controller continues to function as if the sensor ZS has not been configured.

8.3 Temperature monitoring

When certain measured values deviate by a specified value from their set points, an alarm is triggered. The following deviations generate "Err 6" alarms:

- ▶ The flow temperature deviates by at least 10 °C from its set point for longer than 30 min,
- ▶ The room temperature remains at least 2 °C below its set point for longer than 30 min (flash adaptation active),
- ▶ The return flow temperature limitation has been interfering continuously for longer than 30 min.

Function	WE	Configuration
Temperature monitoring	0	CO-SYS -> F14 - 1

8.4 Collective alarm

When this function is active, binary output BA is activated in case of a fault. Alarms are still indicated in info level by displaying "Err".

Function	WE	Configuration
Fault alarm output BA	0	CO-SYS -> F13 - 1

9 Memory pen

A memory pen (accessories; order no. 1400-7697) is particularly useful to transfer all data from one TROVIS 5433 Controller to several other TROVIS 5433 Controllers. The memory pen is plugged into the connector integrated into the front panel. Once the pen has been connected, "33 SP" is displayed. If the memory pen already contains data from a different TROVIS 5433 controller, turn the rotary pushbutton until "SP 33" is displayed.

- ▶ Pressing the rotary pushbutton to confirm "33 SP" causes the controller settings to be transferred to the memory pen.
- ▶ Pressing the rotary pushbutton to confirm "SP 33" causes the saved controller settings to be transferred from the memory pen to the controller.

During the data transfer, the bars on the display indicate the progress of the transfer. When the bars have stopped indicating the transfer progress, the connection between controller and memory pen can be terminated.

A database module for the use of the TROVIS 5433 Controller together with the TROVIS-VIEW 6661 software is available (accessories; order no. 6661-1003). The memory pen needs to be connected to the PC over a serial interface adapter (accessories; order no. 1400-7700). In addition, a complete hardware package (including 1 memory pen, 1 serial interface adapter and 1 connecting cable for direct connection between controller and PC) is available as an accessory (order no. 1400-7704).

Using TROVIS-VIEW, it is possible to adjust all controller settings in a convenient user interface and transfer them to a memory pen. In addition, data can be read from a memory pen to change or print them.

10 Installation

The controller consists of the housing with the electronics and the back panel with the terminals. It is suitable for panel, wall and top hat rail mounting (Fig. 12).

Panel mounting

1. Remove both screws (1).
2. Pull apart the controller housing and the back panel.
3. Make a cut-out of 138 x 92 mm (W x H) in the control panel.
4. Insert the controller housing through the panel cut-out.
5. Insert one mounting clamp (2) each at the side. Screw the threaded rod towards the panel with a screwdriver so that the housing is clamped against the control panel.
6. Install the electrical connections at the back of the housing as described in section 11.
7. Fit the controller housing.
8. Fasten both screws (1).

Wall mounting

1. Remove both screws (1).
2. Pull apart the controller housing and the back panel.
3. If necessary, bore holes with the specified dimensions in the appropriate places.
Fasten the back panel with four screws.
4. Install the electrical connections at the back of the housing as described in section 11.
5. Remount the controller housing.
6. Fasten both screws (1).

Top hat rail mounting

1. Fasten the spring-loaded hook (4) at the bottom of the top hat rail (3).
2. Slightly push the controller upwards and pull the upper hook (5) over the top hat rail.
3. Remove both screws (1).
4. Pull apart the controller housing and the back panel.
5. Install the electrical connections at the back panel as described in section 11.
6. Remount the controller housing.
7. Fasten both screws (1).

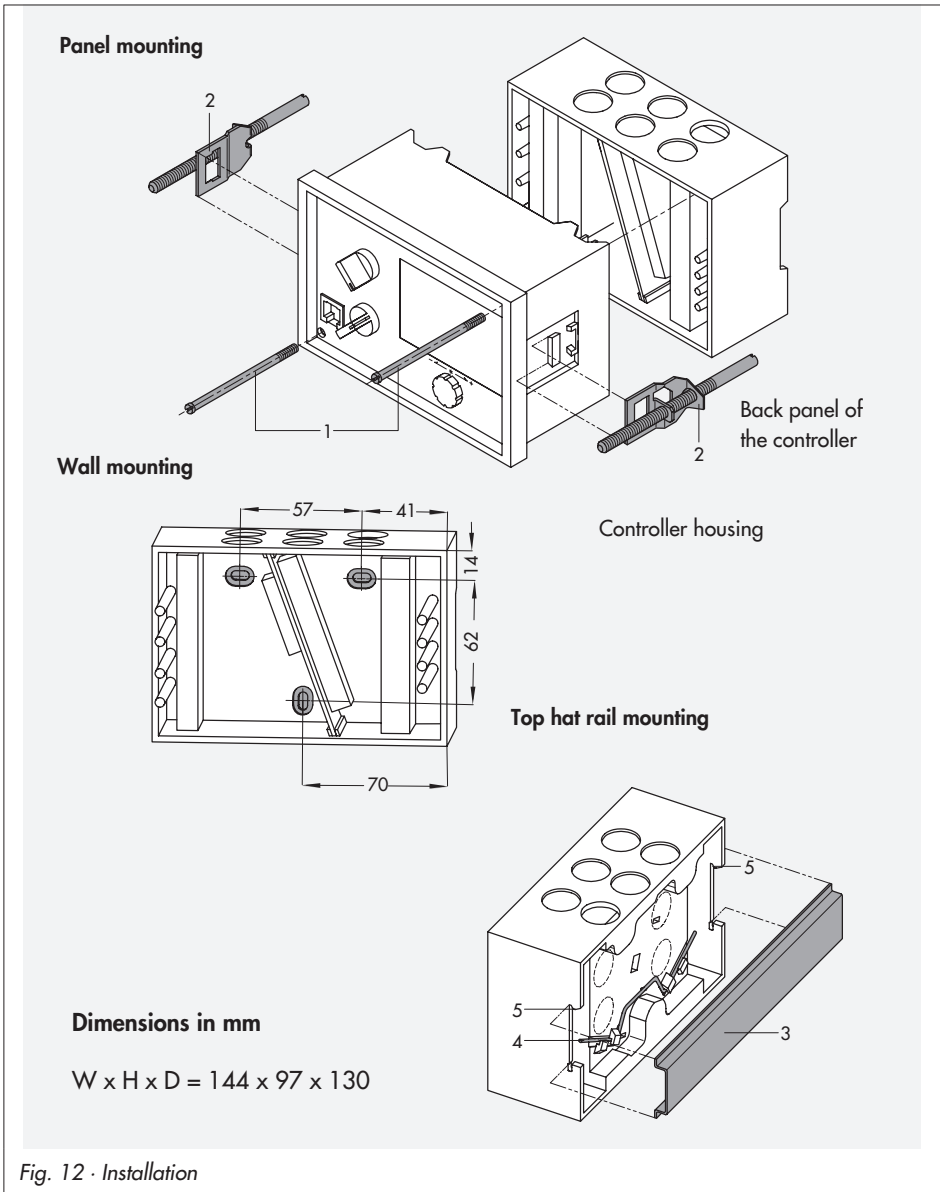

Fig. 12 · Installation

11 Electrical connection

Caution!

For electrical installation, you are required to observe the relevant electrotechnical regulations of the country of use as well as the regulations of the local power suppliers. Make sure all electrical connections are installed by trained and experienced personnel!

Notes on installing the electrical connections

- ▶ Install the 230 V power supply lines and the signal lines separately! To increase noise immunity, observe a minimum distance of 10 cm between the lines. Make sure the minimum distance is also observed when the lines are installed in a cabinet.
- ▶ The lines for digital signals (bus lines) and analog signals (sensor lines, analog outputs) must also be installed separately!
- ▶ In plants with a high electromagnetic noise level, we recommend to use shielded cables for the analog signal lines. Ground the shield at one side, either at the control cabinet inlet or outlet, using the largest possible cross-section. Connect the central grounding point and the PE grounding conductor with a cable $\geq 10 \text{ mm}^2$ using the shortest route.
- ▶ Inductances in the control cabinet, e.g. contactor coils, are to be equipped with suitable interference suppressors (RC elements).
- ▶ Control cabinet elements with high field strength, e.g. transformers or frequency converters, should be shielded with separators providing a good ground connection.

Overvoltage protection

- ▶ If signal lines are installed outside buildings or over large distances, make sure appropriate surge or overvoltage protection measures are taken. Such measures are indispensable for bus lines!
- ▶ The shield of signal lines installed outside buildings must have current conducting capacity and must be grounded on both sides.
- ▶ Surge diverters must be installed at the control cabinet inlet.

Connecting the controller

The controller is connected as illustrated in the diagram on page 75.

Open the housing to connect the cables. To connect the feeding cables, make holes in the marked locations at the top, bottom or back of the rear part of the housing and fit suitable grommets or screw joints.

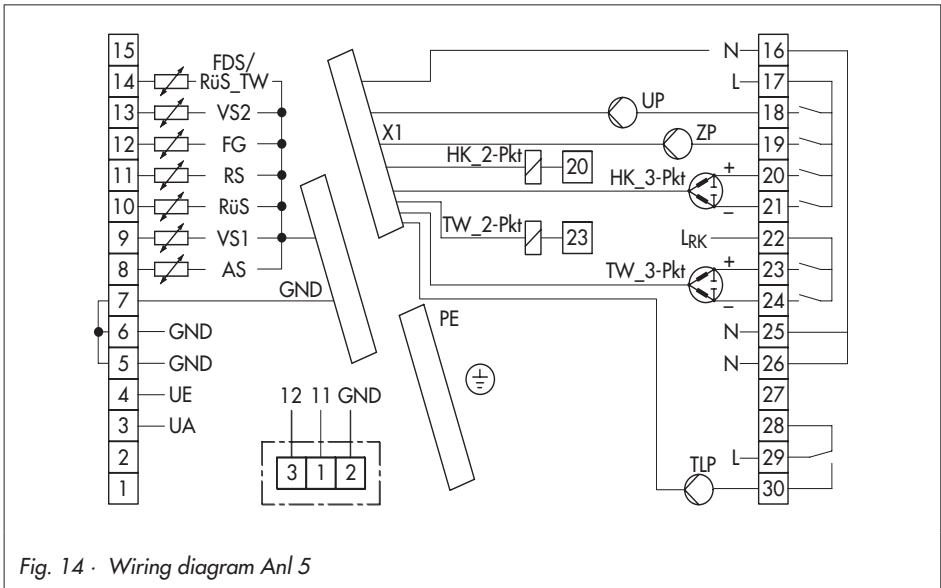
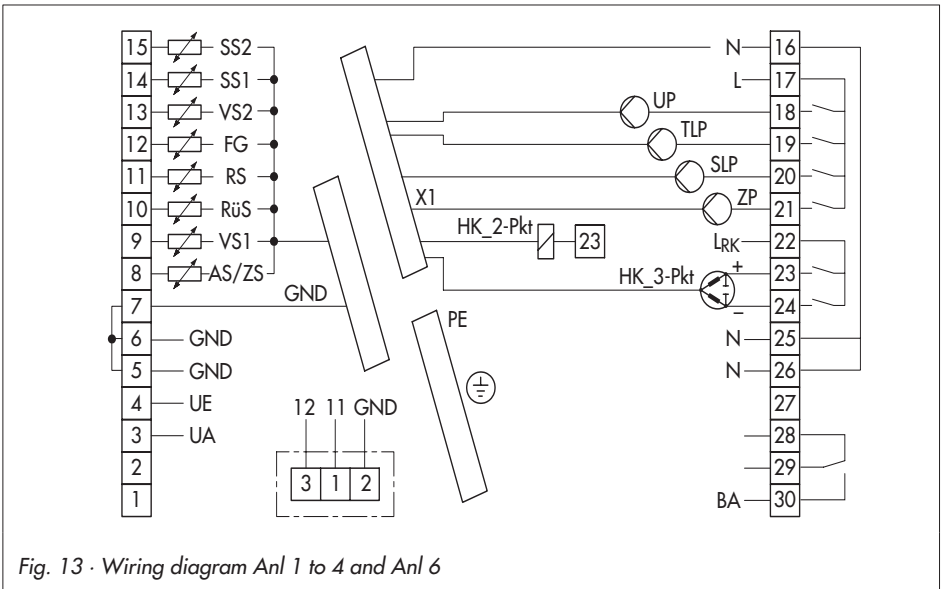

Connecting the sensors

Cables with a min. cross-section of 0.5 mm² can be connected to the terminals at the back panel of the housing.

Connecting the actuators

► 3-step or on/off outputs:

Connect cables with a min. cross-section of 1.5 mm² suitable for damp locations to the terminals of the controller output. The direction of travel needs to be checked at start-up.

Note!

The motorized actuator is not automatically supplied with voltage by the controller. The actuator can be supplied over an external voltage source connected to terminal 22. Alternatively, install a jumper between terminal 17 and terminal 22.

Connecting the pumps

Connect all cables with a min. cross-section of 1.5 mm² to the terminals of the controller as illustrated in the connection diagram.

Legend for connection diagram on page 75:

AS	Outdoor sensor	BA	Binary output
FDS	Hydraulic pressure switch	HK	Heating circuit
FG	Potentiometer	GND	Ground
RS	Room sensor	LrK	Voltage supply for actuator
RüS	Return flow sensor	PE	Grounding conductor
RüS_TW	Return flow sensor for DHW heating	SLP	Storage tank charging pump
SS	Storage sensor	TLP	Exchanger charging pump
VS	Flow sensor	TW	DHW circuit
		UA	Output for demand/outdoor temperature
		UE	Input for demand/outdoor temperature
		UP	Circulation pump (heating circuit)
		ZP	Circulation pump (DHW circuit)

12 Appendix

12.1 Function block lists

CO1: Heating circuit (not system Anl 6)*

F	Function	WE	Anl	Comment Function block parameters / Range of values (default)
01	Room sensor RS	0	All*	CO1 -> F01 - 1: Temperature display and input FG1 active; Options: 1 Types 5244 or 5257-5 Room Panels 2 Standard sensor Function block cannot be selected if CO1 -> F02 - 1, options 2/3 or CO1 -> F03 - 1 or CO1 -> F07 - 0 and CO-SYS -> F11 - 1
02	Optimization	0	All*	CO1-> F02 - 1: Optimization active; Options: 1 ON acc. to t_A , set-back acc. to schedule*, only with CO1 -> F07 - 1 2 ON acc. to t_A , OFF acc. to room sensor*, only with CO1 -> F01 - 1 and CO1 -> F07 - 1 3 ON and OFF according to room sensor, only with CO1 -> F01 - 1 * Function block parameter: Advance heating time / 0 to 360 (120) min
03	Flash adaptation	0	All*	CO1 -> F03 - 1 only with CO1 -> F01 - 1 Function block parameter: Cycle time / 1 to 100 min (10 min) Function block cannot be selected if CO1 -> F07 - 0 and CO-SYS -> F11 - 1
04	Characteristic	0	All*	CO1 -> F04 - 1: 4-point characteristic CO1 -> F04 - 0: Gradient characteristic
05	Delayed outdoor temperature adaptation	0	All*	CO1 -> F05 - 1 only with CO1 -> F07 - 1; Options: 1 When outdoor temperature t_A decreases 2 When outdoor temp. t_A decreases and increases Function block parameter: Delay / 1 to 6 °C/h (3 °C/h)

F Function		WE	Anl	Comment Function block parameters / Range of values (default)
06	Summer mode	0	All*	CO1 -> F06 - 1: Time-controlled summer mode, only with CO1 -> F07 - 1 Function block parameters: Start summer mode / 01.01 to 31.12 (01.06) No. of days until activation/ 1 to 3 (2) Stop summer mode / 01.01 to 31.12 (30.09) No. of days until deactivation / 1 to 3 (1) OT limit value summer mode / 0 to 50 °C (18 °C)
07	Outdoor temperature t_A	1	All*	CO1 -> F07 - 1: Weather-compensated control active CO1 -> F07 - 0: Fixed set point control Function block cannot be selected if: CO1 -> F05 - 1 or CO1 -> F06 - 1 or CO1 -> F08 - 1 or CO-SYS -> F12 - 1 or CO1 -> F02 - 1, options 1/2
08	Outdoor temperature 0 to 10 V at input UE	0	All*	CO1 -> F08 - 1: t_A at input UE, only with CO1 -> F07 - 1 and CO-SYS -> F11 - 0 CO1 -> F08 - 0: t_A at input AS
09	Drying of jointless floor	0	All*	CO1 -> F09 - 1: Start the drying of jointless floor program only by selecting <i>START 1</i> Function block parameters: Temperature rise / 1.0 to 10 °C / 24 h (5.0 °C / 24 h) Maximum temperature / 25 to 60 °C (45 °C) Maintaining time of maximum temperature / 1 to 10 days (4) Temperature reduction / 0.0 to 10.0 °C / 24 h (5.0 °C/24 h) Option: START 1

F Function block number, WE Default value, Anl System code number

CO2: DHW circuit

F	Function	WE	Anl	Comment Function block parameters / Range of values (default)
01	Storage sensor SS1	1	2, 3, 4, 6	CO2 -> F01 - 1: Sensor SS1 ON CO2 -> F01 - 0: Storage tank thermostat, only with CO2 -> F02 - 0 Function block cannot be selected if: CO2 -> F02 - 1, CO2 -> F05 - 1, CO2 -> F08 - 1 or CO2 -> F19 - 1
02	Storage sensor SS2	0	2	CO2 -> F02 - 1: Sensor SS2 ON, only with CO2 -> F01 - 1
		1	3, 4, 6	
03	Flow sensor VS2	0	3, 6	CO2 -> F03 - 1: Flow sensor VS2 to measure the storage tank charging temperature active (control switchover)
04	Operation of circulation pump during storage tank charging	0	2, 3, 4	CO2 -> F04 - 1: Circulation pump (ZP) operates according to schedule during storage tank charging
05	Thermal disinfection	0	2, 3, 4, 6	CO2 -> F05 - 1*: Function block parameters: Day of the week / 0 to 7 (3) with 0 = every day Start time / 0:00 h to 23:30 h (0:00 h) Stop time / 0:00 h to 23:30 h (4:00 h) Disinfection temperature / 60 to 90 °C (70 °C) * In Anl 2, 3, 4 and 6: only with CO2 -> F01 - 1 In Anl 5: the function block cannot be selected if: CO2 -> F13 - 1 or CO2 -> F14 - 1
06	Parallel pump operation	0	2, 3	CO2 -> F06 - 1 only with CO2 -> F10 - 0; Options: 1 Parallel pump operation with UP and SLP 2 Control of changeover valve and UP Function block parameter (Anl 2, option 1 or Anl 3): Stop parallel operation in case of deviation /---, 60 to 600 sec (600 sec)
07	Vacations and holidays also valid for DHW	0	2, 3, 4, 5	CO2 -> F07 - 1: Vacations and holidays also apply to DHW heating

F	Function	WE	Anl	Comment Function block parameters / Range of values (default)
08	SLP ON depending on return flow temperature	0	2, 4*, 6	CO2 -> F08 - 1 only with CO2 -> F01 - 1 and CO-SYS -> F01 - 1 * In system Anl 4 only applicable when implemented as a secondary system. To do so, mount return flow sensor RüS in the primary circuit in the heat exchanger of the storage tank charging system; the sensor is not used for return flow temperature limitation!
09	Priority for DHW heating	0	4, 5*	CO2 -> F09 - 1: Options: 1 Reverse control 2 Set-back operation Function block parameters: Activate priority in case of deviation / 60 to 600 sec (300 sec) Monitoring value / 20 to 90 °C (40 °C) * Cannot be selected in Anl 5 if CO2 -> F13 - 1
10	Intermediate heating	1	2, 3	CO2 -> F10 - 1: 10 min of intermediate heating after 20 min; only with CO2 -> F06 - 0 CO2 -> F10 - 0: Priority for DHW heating
11	Control mode DHW	1	5	CO2 -> F11 - 1: Three-step control Function block parameters: K _p (proportional gain) / 0.1 to 50.0 (2.0) T _N (reset time) / 0 to 999 sec (120 sec) T _v (valve transit time) / 10 to 240 sec (45 sec) CO2 -> F11 - 0: On/off control Function block parameters: Hysteresis / 2 to 10 °C (5 °C) Min. ON time / 0 to 600 sec (120 sec) Min. OFF time / 0 to 600 sec (120 sec) Function block cannot be selected if: CO2 -> F13 - 1 or CO2 -> F14 - 1
12	Return flow sensor DHW RüS_TW	1	5	CO2 -> F12 - 1: Return flow temperature limitation in DHW circuit active, only with CO2 -> F11 - 1 and CO2 -> F14 - 0 Function block parameter: Limiting factor / 0.1 to 10 (1.0)
13	On/off valve and thermostat	0	5	CO2 -> F13 - 1: On/off valve (controlled over outputs DHW + and DHW -) and thermostat at input VS2; only with CO2 -> F11 - 0 and CO2 -> F14 - 0 Function block parameter: Valve transit time / 10 to 240 sec (45 sec) CO2 -> F13 - 0: Temperature valve (output DHW+) and temperature sensor at input VS2

F	Function	WE	Anl	Comment Function block parameters / Range of values (default)
14	Instantaneous system with hydraulic pressure switch	0	5	CO2 -> F14 - 1: Instantaneous system w. hydraulic pressure switch Function block parameters: K _P (proportional gain) / 0.1 to 50.0 (2.0) T _N (reset time) / 0 to 999 sec (120 sec) d component / 0 to 999 sec (0 sec) K _P T _V (proportional gain d component) / 0.1 to 10.0 (1.0) T _V (valve transit time) / 10 to 240 sec (45 sec)
15	Limit deviation for OPEN signal DHW	0	5	CO2 -> F15 - 1 only with CO2 -> F11 - 1 or CO2 -> F14 - 1 Function block parameter: Max. deviation / 2 to 10 °C (2 °C)
16	Release continuous signal for DHW	0	5	CO2 -> F16 - 1 only with CO2 -> F11 - 1 or CO2 -> F14 - 1; continuous signal only for actuator with limit switch control
17	Circulation sensor	0	6	CO2 -> F17 - 1: Circulation sensor ZS for measuring the return flow temperature of the circulation circuit is active
18	Circulation pump integrated into heat exchanger	0	6	CO2 -> F18 - 1: DHW circuit control active when the circulation pump ZP is running
19	Thermal disinfection over a binary input	0	2, 3, 4, 5, 6	CO2 -> F19 - 1* with input RS functioning as a binary input Function block parameters (only when CO2 -> F05 - 0): Start time / 0:00 h to 23:30 h (0:00 h) Stop time / 0:00 h to 23:30 h (4:00 h) Disinfection temperature / 60 to 90 °C (70 °C) * In Anl 2, 3, 4 and 6: only with CO2 -> F01 - 1 In Anl 5: the function block cannot be selected if: CO2 -> F13 - 1 or CO2 -> F14 - 1
20	Time-controlled thermal disinfection	0	2, 3, 4, 5, 6	CO2 -> F20 - 1: The thermal disinfection remains active in all circumstances during the entire time (start time to stop time)

F Function block number, WE Default value, Anl System code number

CO-SYS: General functions (all systems)

F	Function	WE	Anl	Comment Function block parameters / Range of values (default)
01	Return flow sensor RüS	1	All	CO-SYS -> F01 - 1: Return flow temperature limitation active; Function block parameter: Limiting factor / 0.1 to 10.0 (1.0) Function block cannot be selected if CO2 -> F08 - 1
02	Sensor selection	1	All	CO-SYS -> F02 - 1: Pt1000 sensors CO-SYS -> F02 - 0: PTC sensors
03	Summer time/ winter time changeover	1	All	CO-SYS -> F03 - 1: Automatic changeover
04	Locking the manual level	0	All	CO-SYS -> F04 - 1: Manual level locked; automatic mode applies in switch positions -, 0, +
05	Control mode	1	All	CO-SYS -> F05 - 1: Three-step control Function block parameters: K _p (proportional gain) / 0.1 to 50 (2.0) T _N (reset time) / 0 to 999 sec (120 sec) T _V (valve transit time) / 10 to 240 sec (45 sec) CO-SYS -> F05 - 0: On/off control Function block parameters: Hysteresis / 2 to 10 °C (5 °C) Min. ON time / 0 to 600 sec (120 sec) Min. OFF time / 0 to 600 sec (120 sec)
06	Limit deviation for OPEN signal	0	All	CO-SYS -> F06 - 1 only with CO-SYS -> F05 - 1 Function block parameter: Max. deviation / 2 to 10 °C (2 °C)
07	Release continuous signal for heating circuit	0	All	CO-SYS -> F07 - 1 only with CO-SYS -> F05 - 1; continuous signal only for actuator with limit switch control
08	Sensor calibration	0	All	CO-SYS -> F08 - 1: Measured values of all connected sensors can be calibrated
09	Default parameter values	0	All	CO-SYS -> F09 - 1: All parameters are reset to their default values (WE)

F	Function	WE	Anl	Comment Function block parameters / Range of values (default)
10	External demand, request	0	1, 4, 5*, 6	CO-SYS -> F10 - 1: Secondary controller, only with CO-SYS -> F11 - 0 and CO-SYS -> F12 - 0 Function block parameters Transmission lower range value / 0 to 130 °C (0 °C) Transmission upper range value / 0 to 130 °C (120 °C) Additional parameter with Anl 4, 5* and 6: With CO2 -> F01 - 0: Requested value / 20 to 90 °C (70 °C) With CO2 -> F01 - 1: Boost / 0 to 30 °C (0 °C) * In Anl 5, only with CO2 -> F11 - 1 and CO2 -> F14 - 0
11	External demand, processing	0	1, 2, 3, 4, 5	CO-SYS -> F11 - 1: Primary controller, only with CO-SYS -> F10 - 0 and CO1-> F08 - 0 and CO1 -> F01 - 0 Function block parameter: Boost / 0 to 30 °C (0 °C)
12	Forward outdoor temperature, 0 to 10 V	0	1, 2, 3, 4, 5	CO-SYS -> F12 - 1 Only with CO-SYS -> F10 - 0 and CO1 -> F07 - 1
13	Fault alarm output BA	1	All	CO-SYS -> F13 - 1: Output BA is activated in case of fault In systems Anl 1, 4, 6: CO-SYS -> F13 - 0: Output boiler demand In system Anl 5: CO-SYS -> F13 - 0: Output for TLP activated
14	Temperature monitoring	0	All	CO-SYS -> F14 - 1: Temperature monitoring VS, RS and RüS
15	Locking the rotary switches	0	All	CO-SYS -> F15 - 1: Rotary switches locked
16	Binary output BA activated during thermal disinfection	0	2, 3, 4, 5, 6	CO-SYS -> F16 - 1 Only with CO-SYS -> F13 - 0

F Function block number, WE Default value, Anl System code number

12.2 Parameter lists

PA1: Heating circuit

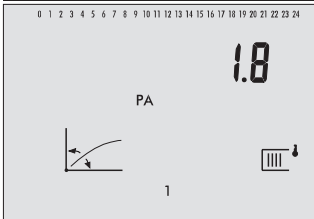
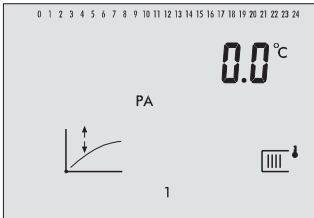
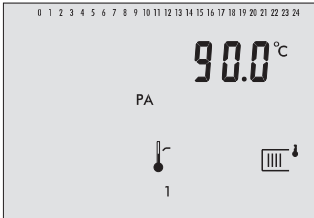
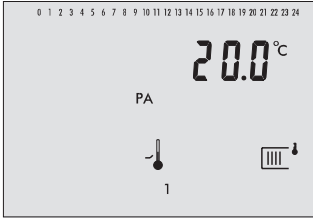
Display	Parameter designation Range of values (default)
	<p>Gradient, flow</p> <p>0.2 to 3.2 (1.8)</p> <p>Only with CO1 -> F04 - 0 and CO1 -> F07 - 1.</p>
	<p>Level, flow (parallel transport)</p> <p>-30 to 30 °C (0 °C)</p> <p>Only with CO1 -> F04 - 0 and CO1 -> F07 - 1.</p>
	<p>Max. flow temperature</p> <p>Min. flow temperature to 130 °C (90 °C)</p>
	<p>Min. flow temperature</p> <p>0 °C to max. flow temperature (20 °C)</p>

Display

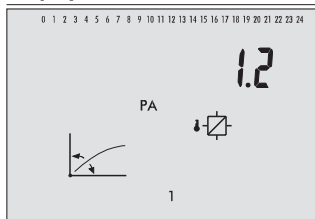
Parameter designation
Range of values (default)

Gradient, return flow

0.2 to 3.2 (1.2)

Only with

CO1 -> F04 - 0 and CO1 -> F07 - 1 and CO-SYS -> F01 - 1.

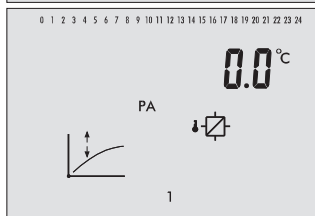

Level, return flow

-30 to 30 °C (0 °C)

Only with

CO1 -> F04 - 0 and CO1 -> F07 - 1 and CO-SYS -> F01 - 1.

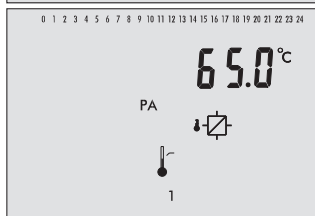

Max. return flow temperature

20 °C to 90 °C (65 °C)

Only with (CO1 -> F07 - 0 and CO-SYS -> F01 - 1) or

(CO1 -> F04 - 0 and CO1 -> F07 - 1 and CO-SYS -> F01 - 1).

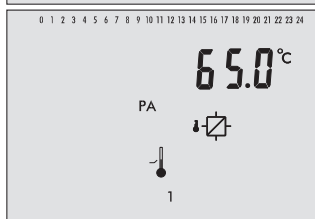

Return flow temperature foot

20 °C to 90 °C (65 °C)

Only with

CO1 -> F04 - 0 and CO1 -> F07 - 1 and CO-SYS -> F01 - 1.

Display

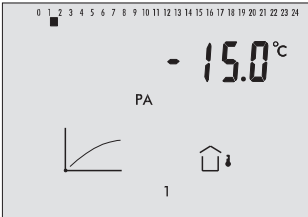

Parameter designation

Range of values (default)

4-point characteristic

Point 1: Outdoor temperature

Outdoor temperatures of the points 2, 3, 4 are marked by squares below the numbers 2, 3, 4.

-30 to 50 °C

(point 1: -15 °C, point 2: -5 °C, point 3: 5 °C, point 4: 15 °C)

Only with CO1 -> F04 - 1 and CO1 -> F07 - 1.

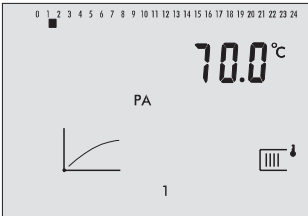

4-point characteristic

Point 1: flow temperature

Flow temperatures of the points 2, 3, 4 are marked by squares below the numbers 2, 3, 4.

20 to 130 °C

(point 1: 70 °C, point 2: 55 °C, point 3: 40 °C, point 4: 25 °C)

Only with CO1 -> F04 - 1 and CO1 -> F07 - 1.

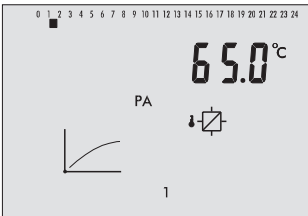

4-point characteristic

Point 1: Return flow temperature

Reduced flow temperatures of the points 2, 3, 4 are marked by squares below the numbers 2, 3, 4.

20 to 90 °C (points 1 to 4: 65 °C)

Only with

CO1 -> F04 - 1 and CO1 -> F07 - 1 and CO-SYS -> F01 - 1.

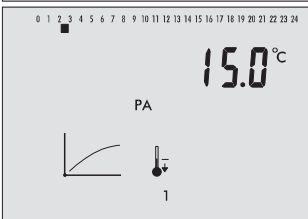

4-point characteristic

Set-back difference at point 2

Set-back difference at point 3 is marked by a square below the number 3.

0 to 50 °C (points 2 to 3: 15 °C)

Only with CO1 -> F04 - 1 and CO1 -> F07 - 1.

Display

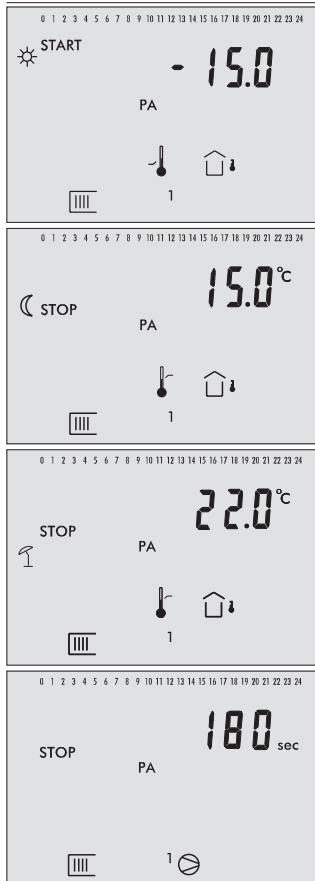
Parameter designation
Range of values (default)

OT activation value rated operation

-30 °C to OT deactivation value reduced operation (-15 °C)

Only with CO1 -> F07 - 1.

OT deactivation value reduced operation

OT activation value rated operation to 50 °C (15 °C)

Only with CO1 -> F07 - 1.

OT deactivation value rated operation

0 to 50 °C (22 °C)

Only with CO1 -> F07 - 1.

Lag time of heating circulation pump

15 to 2400 sec (180 sec)

PA2: DHW circuit

Display

Parameter designation

Range of values (default)

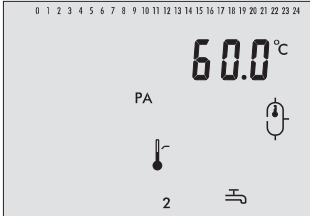

Max. DHW temperature

20 to 90 °C (60 °C)

Anl 2, 3, 4: only with CO2 -> F01 - 1.
Anl 5: not with CO2 -> F13 - 1.

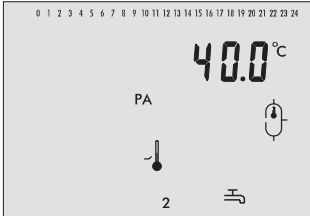

Min. DHW temperature

20 to 90 °C (40 °C)

Anl 2, 3, 4: only with CO2 -> F01 - 1.
Anl 5: not with CO2 -> F13 - 1.

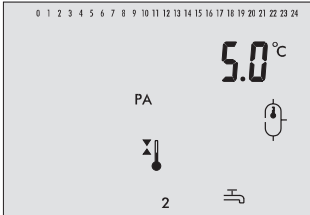

Hysteresis

0 to 30 °C (5 °C)

Only with CO2 -> F01 - 1.

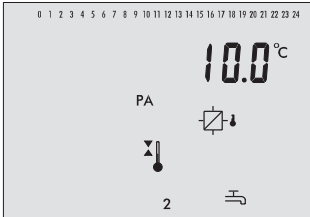

Charging temperature boost

0 to 30 °C (10 °C)

Only with CO2 -> F01 - 1.

Display

Parameter designation
Range of values (default)

Stop charging

20 to 90 °C (53 °C)

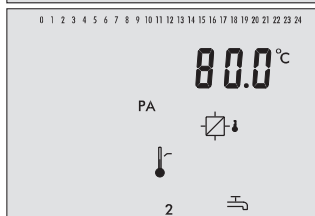

Storage tank charging pump OFF

20 to 90 °C (53 °C)
Only Anl 3 with CO2 -> F03 - 1

Max. charging temperature

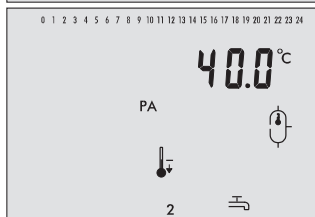
20 to 120 °C (80 °C)
Only Anl 3 with CO2 -> F03 - 1

Sustained DHW temperature

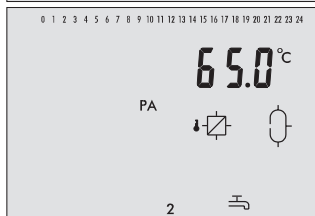
20 to 90 °C (40 °C)
Anl 2, 3, 4: only with CO2 -> F01 - 1.
Anl 5: only with CO2 -> F13 - 0 and CO2 -> F14 - 0.

Max. return flow temperature

20 to 90 °C (65 °C)
Anl 2, 3: only with CO-SYS -> F01 - 1.
Anl 5: only with CO2 -> F11 - 1 and CO2 -> F12 - 1 and
CO2 -> F14 - 0.

Display

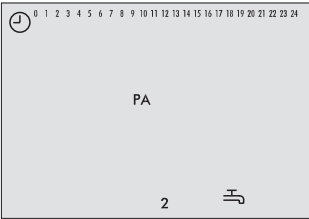

Parameter designation
Range of values (default)

Times-of-use DHW heating

0:00 h to 24:00 h (every day: 0:00 h to 24:00 h)

PA-SYS: General parameters

Display

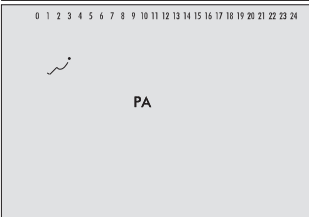

Parameter designation
Range of values

Public holidays

01.01 to 31.12 -> section 1.6.1

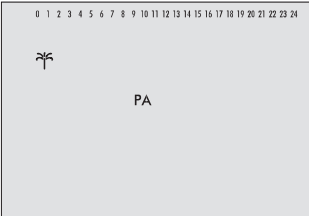

Vacation periods

01.01 to 31.12 -> section 1.6.2

12.3 Sensor resistance tables

Resistance values with PTC measuring element

Type 5224 Outdoor Temperature Sensor, Type 5264 and Type 5265 Flow and Return Flow Temperature Sensor, Type 5264 Storage Tank Temperature Sensor

°C	-20	-10	0	10	20	25	30	40	50	60	70	80	90	100	110	120
Ω	694	757	825	896	971	1010	1050	1132	1219	1309	1402	1500	1601	1706	1815	1925

Type 5244 Room Panel

°C	10	15	20	25	30
Ω	679	699	720	741	762

Switch position ⊕, terminals 1 and 2

Resistance values with Pt1000 measuring element

Type 5227-2 Outdoor Temperature Sensor, Type 5277-2 (thermowell required) and Type 5267-2 (contact sensor) Flow, Return Flow and Storage Tank Temperature Sensors, Type 5207-61 for instantaneous system VS2.

Type 5257-1, Type 5257-5 (room panel) Room Temperature Sensors.

°C	-35	-30	-25	-20	-15	-10	-5	0	5	10
Ω	862.5	882.2	901.9	921.6	941.2	960.9	980.4	1000.0	1019.5	1039.0

°C	15	20	25	30	35	40	45	50	55	60
Ω	1058.5	1077.9	1097.3	1116.7	1136.1	1155.4	1174.7	1194.0	1213.2	1232.4

°C	65	70	75	80	85	90	95	100	105	110
Ω	1251.6	1270.7	1289.8	1308.9	1328.0	1347.0	1366.0	1385.0	1403.9	1422.9

°C	115	120	125	130	135	140	145	150
Ω	1441.7	1460.6	1479.4	1498.2	1517.0	1535.8	1554.5	1573.1

12.4 Technical data

Inputs	<p>7 inputs for Pt 1000 or PTC temperature sensors in 2-wire connection Input at terminal 14 alternatively for storage tank thermostat 1 input for room panel/potentiometer 1 input for demand/outdoor temperature 0 to 10 V, $R_i = 20 \text{ k}\Omega$ (demand: 0 to 10 V correspond with 0 to 120 °C flow temperature) (outdoor temperature: 0 to 10 V correspond with -40 to 50 °C outdoor temperature)</p>
Outputs	<p>Three-step or on/off signal at terminals 23/24: Load 20 to 250 V AC, 0.5 A (triac outputs with varistor suppression) Three-step or on/off signal at terminals 20/21: Load 230 V AC, 2 A (relay outputs with varistor suppression) 3 pump outputs: Load max. 230 V AC, 2A (relay outputs with varistor suppression) 1 output for demand/outdoor temperature 0 to 10 V, load > 2 kΩ</p>
Operating voltage	230 V AC (+10 %, -15 %), 48 to 62 Hz, max. 3 VA
Ambient temperature	0 to 50 °C (operation), -10 °C to 60 °C (storage and transport)
Relative humidity	Normal, no dew formation
Degree of protection	IP 40 according to EN 60529
Class of protection	I according to EN 50178
Degree of contamination	2 according to EN 50178
Overvoltage category	II according to EN 50178
Noise immunity	According to EN 61000-6-1
Noise emission	According to EN 61000-6-3
Weight	Approx. 0.6 kg

12.5 Customer data

Station	
Operator	
Relevant SAMSON office	
System code number	

Function block settings in configuration levels

	CO1	CO2	CO-SYS
F01			
F02			
F03			
F04			
F05			
F06			
F07			
F08			
F09			
F10			
F11			
F12			
F13			
F14			
F15			
F16			
F17			
F18			
F19			
F20			

Parameters in level 1 (heating circuit)

Parameters		Level 1				Range of values
Gradient, flow						0.2 to 3.2
Level, flow						-30 to 30 °C
Max. flow temperature						min. VT to 130 °C
Min. flow temperature						0 °C to max. VT
Gradient, return flow						0.2 to 3.2
Level, return flow						-30 to 30 °C
Max. return flow temperature						20 to 90 °C
Return flow temperature foot						20 to 90 °C
4-point characteristic		Point 1	Point 2	Point 3	Point 4	
Outdoor temperature						-30 to 50 °C
Flow temperature						20 to 130 °C
Return flow temperature						20 to 90 °C
Set-back difference		-			-	0 to 50 °C
OT activation value in rated operation						-30 °C to OT deactivation value reduced operation
OT deactivation value in reduced operation						OT activation value rated operation to 50 °C
OT deactivation value in rated operation						0 to 50 °C
Lag time of heating circulation pump						15 to 2400 s

Function block parameters	CO1	Range of values
Advance heating time (F02 - 1)		0 to 360 min
Cycle time (F03 - 1)		1 to 100 min
Delay (F05 - 1)		1 to 6 °C/h
Start summer mode (F06 - 1)		01.01 to 31.12
No. of days until activation (F06 - 1)		1 to 3
Stop summer mode (F06 - 1)		01.01 to 31.12
No. of days until deactivation (F06 - 1)		1 to 3
Outdoor temperature limit summer (F06 - 1)		0 to 50 °C
Temperature rise (F09 - 1)		1.0 to 10.0 °C/24 h
Maximum temperature (F09 - 1)		25 to 60 °C

Function block parameters	CO1	Range of values
Maintaining time of max. temp. (F09 - 1)		1 to 10 days
Temperature reduction (F09 - 1)		0.0 to 10.0 °C/24 h

Parameters in level 2 (DHW circuit)

Parameters	Level 2							Range of values
Max. DHW temperature								20 to 90 °C
Min. DHW temperature								20 to 90 °C
Hysteresis								0 to 30 °C
Charging temperature boost								0 to 30 °C
Stop storage tank charging								20 to 90 °C
Storage tank charging pump OFF								20 to 90 °C
Max. charging temperature								20 to 120 °C
Sustained DHW temperature								20 to 90 °C
Max. return flow temperature								20 to 90 °C
Times-of-use DHW heating	Mon	Tue	Wed	Thu	Fri	Sat	Sun	
Start first time-of-use								0:00 to 24:00 h
Stop first time-of-use								0:00 to 24:00 h
Start second time-of-use								0:00 to 24:00 h
Stop second time-of-use								0:00 to 24:00 h
Start third time-of-use								0:00 to 24:00 h
Stop third time-of-use								0:00 to 24:00 h

Function block parameters	CO2	Range of values
Day of the disinfection (F05 - 1)		0 (daily), 1 to 7 (Mon to Sun)
Start time (F05 - 1, F19 - 1)		0:00 to 23:30 h
Stop time (F05 - 1, F19 - 1)		0:00 to 23:30 h
Disinfection temperature (F05 - 1, F19 - 1)		60 to 90 °C
Stop parallel operation in case of deviation (F06 - 1)		---, 60 to 600 s
Activate priority in case of deviation (F09 - 1)		60 to 600 s
Monitoring value (F09 - 1)		20 to 90 °C

Function block parameters	CO2	Range of values
K_p (proportional gain) (F11 - 1)		0.1 to 50.0
T_N (reset time) (F11 - 1)		0 to 999 s
T_V (valve transit time) (F11 - 1)		10 to 240 s
Hysteresis (F11 - 0)		2 to 10 °C
Min. ON time (F11 - 0)		0 to 600 s
Min. OFF time (F11 - 0)		0 to 600 s
Limiting factor (F12 - 1)		0.1 to 10
Valve transit time (F13 - 1)		10 to 240 s
K_p (proportional gain) (F14 - 1)		0.1 to 50.0
T_N (reset time) (F14 - 1)		0 to 999 s
d component (F14 - 1)		0 to 999 s
$K_p T_V$ (d component of the proportional gain) (F14 - 1)		0.1 to 10.0
T_V (valve transit time) (F14 - 1)		10 to 240 s
Max. deviation (F15 - 1)		2.0 to 10.0 °C

Key number:
1732

Parameters in level SYS (system-wide)

Parameters (PA-SYS)	Level 3					Range of values
Public holidays						01.01 to 31.12
Vacation periods, start						01.01 to 31.12
Vacation periods, stop						
Vacation periods, start						
Vacation periods, stop						
Function block parameters	CO-SYS					
Limiting factor (F01 - 1)						0.1 to 10
K _p (proportional gain) (F05 - 1)						0.1 to 50
T _N (reset time) (F05 - 1)						0 to 999 s
T _γ (valve transit time) (F05 - 1)						10 to 240 s
Hysteresis (F05 - 0)						2 to 10 °C
Min. ON time (F05 - 0)						0 to 600 s
Min. OFF time (F05 - 0)						0 to 600 s
Max. deviation (F06 - 1)						2 to 10 °C
Transmission lower range value (F10 - 1)						0 to 130 °C
Transmission upper range value (F10 - 1)						0 to 130 °C
Requested value (F10 - 1)						20 to 90 °C
Boost (F10 - 1, F11 - 1)						0 to 30 °C

Index

A		Frost protection	59
Automatic operation	7	Function block lists	76
B		Function block number	19, 20
Boiler systems	27	Functions, activate and deactivate	19
C		H	
Characteristic		Heating characteristic	36
4-point characteristic	38	I	
Gradient characteristic	37	Installation	
Condensate accumulation control	61	Panel mounting	71
Configuration level	19, 76	Top hat rail mounting	71
Connection		Wall mounting	71
Actuator	75	Intermediate heating	54
Controller	73	J	
Pump	75	Jointless floors	39
Sensor	75	K	
Connection diagram	74	Key number	18
Controller time	10	M	
Customer data	92	Manual operation	7, 25
D		Max. charging temperature reached	68
Default values (WE)	24	Memory pen	70
DHW heating		O	
In the instantaneous water system	53	On/off control	62
In the storage tank system	48	Operating elements	6
In the storing tank charging system	50	Operating modes	7
Display	8	Optimization	45
Drying jointless floors	39	Outdoor temp. adaptation, delayed	42
E		Overvoltage protection	73
Electrical connection	73 - 75	P	
F		Parameter level	21
Fixed set point control	39	Parameter list	83
Flash adaptation	46	Parameters	21
Floating switch	44		
Forced charging of DHW storage tank	56		
Forced operation of the pumps	59		

Priority through		Thermal disinfection of the DHW	
Reverse control	55	storage tank	56
Set-back operation	55	Three-step control	62
Public holidays	13	TROVIS-VIEW	70
R		V	
Rated operation	7	Vacation periods	15
Reduced operation	7	W	
Return flow temperature limitation	60	Weather-compensated control	36
Reverse control		Wiring	74
Priority through ~	55		
Room sensors			
Pt1000	43		
PTC	43		
Rotary pushbutton	6		
Rotary switches			
Configuration and parameterization	6		
Operating modes	7		
S			
Sensor calibration	22		
Sensor failure	68		
Sensor resistance tables	90		
Set point			
Day	37		
Night	37		
Set-back operation			
Priority through ~	55		
Setting the times-of-use	11		
Standby operation	7		
Start-up	18 - 24		
Summer mode	42		
Summer time/winter time changeover	59		
System code number	18		
Systems	26 - 35		
T			
Technical data	91		
Temperature set points	17		

Frequently used abbreviations

<i>AS</i>	Outdoor sensor	<i>RüS</i>	Return flow sensor
<i>Anl</i>	System	<i>RüT</i>	Return flow temperature
<i>BA</i>	Binary output	<i>SS</i>	Storage sensor
<i>BE</i>	Binary input	<i>SLP</i>	Storage tank charging pump
<i>CO</i>	Configuration level	<i>t</i>	Time
<i>EB</i>	Mounting and operating instructions	<i>T</i>	Temperature
<i>F</i>	Function block	<i>TLP</i>	Exchanger charging pump
<i>FDS</i>	Hydraulic pressure switch	<i>TW</i>	DHW temperature
<i>HK</i>	Heating circuit	<i>TWE</i>	DHW heating
<i>GLT</i>	Building control station	<i>UP</i>	Circulation pump (heating circuit)
<i>KI</i>	Terminal	<i>VS</i>	Flow sensor
<i>KW</i>	Cold water	<i>VT</i>	Flow temperature
<i>OT</i>	Outdoor temperature	<i>WE</i>	Default value
<i>PA</i>	Parameter level	<i>WW</i>	Warm water
<i>RS</i>	Room sensor	<i>ZP</i>	Circulation pump (DHW circuit)
<i>RK</i>	Control loop		



SAMSON AG · MESS- UND REGELTECHNIK
Weismüllerstraße 3 · 60314 Frankfurt am Main · Germany
Phone: +49 69 4009-0 · Fax: +49 69 4009-1507
Internet: <http://www.samson.de>

EB 5433 EN

2009-09