

T 5863 EN

Type 3226 Three-way Valve

Types 3226/5857, 3226/5824, 3226/5825, 3226/5757-7, 3226/5724-8, 3226/5725-7, 3226/5725-8 Electric Control Valves

Type 3226/2780 Pneumatic Control Valve

Application

Control valves available as mixing or diverting valves for use in heating, ventilation and air-conditioning systems
 DN 15 to 50, G ½ to G 1 · PN 25 · Version up to 150 °C
 (water and non-flammable gases)

Special features

- Type 3226 Three-way Valve designed as a **mixing valve** with male thread connection and welding ends or threaded ends (DN 15 to 50) or with female thread connection (G ½ to G 1)
- Type 3226 Three-way Valve designed as a **diverting valve** with male thread connection and welding ends or threaded ends (DN 15 to 50)
- Type 3226 Three-way Valve combined with Type 5857 and TROVIS 5757-7 (with special spring)
- Force-locking connection between valve and actuator
- Type 3226 Three-way Valve available as a mixing or diverting valve in special version with DVGW test

Versions

Electric control valves		
Type 3226/5857	PN 25	DN 15 to 25 · G ½ to G 1
Type 3226/5824	PN 25	DN 15 to 50 · G ½ to G 1
Type 3226/5825 ¹⁾	PN 25	DN 15 to 50 · G ½ to G 1
Electric control valveS with electric actuator with process controller for heating and cooling applications		
Type 3226/5757-7	PN 25	DN 15 to 25 · G ½ to G 1
Type 3226/5724-8	PN 25	DN 15 to 50 · G ½ to G 1
Type 3226/5725-7 ¹⁾	PN 25	DN 15 to 50 · G ½ to G 1
Type 3226/5725-8 ¹⁾	PN 25	DN 15 to 50 · G ½ to G 1
Pneumatic control valves		
Type 3226/2780-1	PN 25	DN 15 to 50 · G ½ to G 1
Type 3226/2780-2 ²⁾	PN 25	DN 15 to 50 · G ½ to G 1

¹⁾ Electric actuators with fail-safe action

²⁾ Pneumatic actuator suitable for integrated positioner attachment

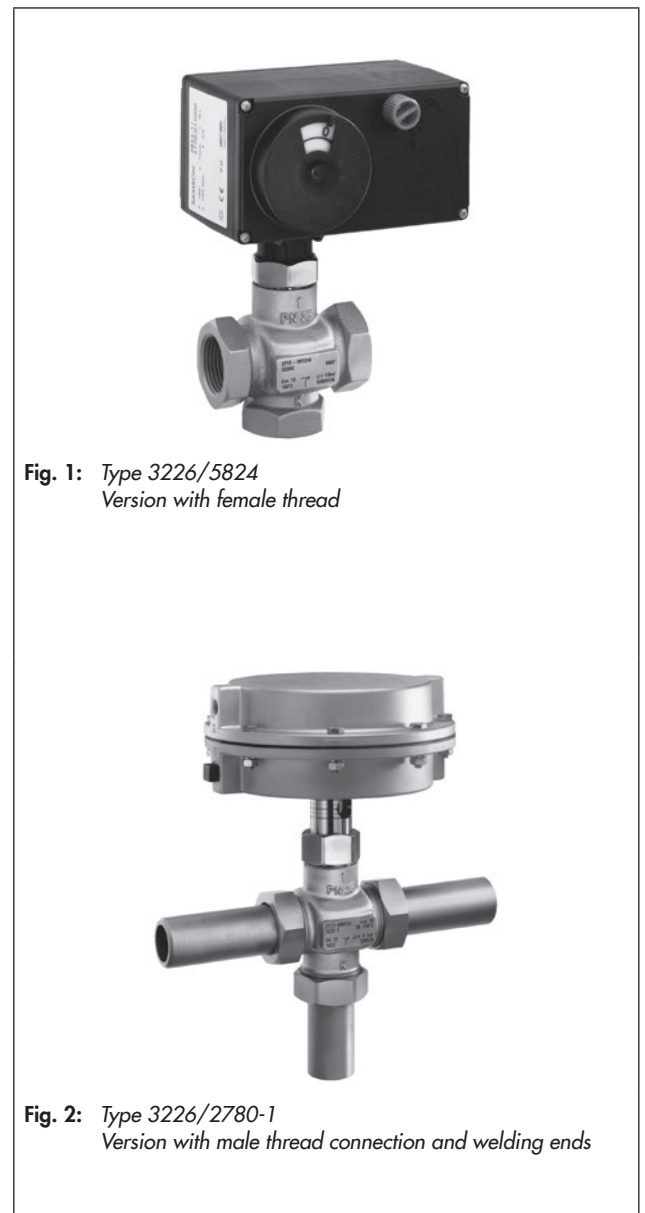

Fig. 1: Type 3226/5824
Version with female thread

Fig. 2: Type 3226/2780-1
Version with male thread connection and welding ends

Also available:

Type 3226 Three-way Valve with flanges ▶ T 5861

Principle of operation (Fig. 3)

The three-way valve in the version with male thread connection and welding ends or threaded ends can be used for both mixing or diverting valves. The valves vary in the plug arrangement and must be installed accordingly. The version with female thread connection can only be used for mixing valves. The process medium flows through the three-way valve in the direction indicated by the arrow. The position of the plug (3) determines the cross-sectional area of flow between the plug and the seat (2). The plug follows the actuator stem, which is changed by the control signal acting on the actuator (8), owing to the force of the valve spring (5). The valve (1) and actuator (8) have a force-locking connection.

An intermediate insulating piece is available for insulated pipes.

Fail-safe position (Fig. 4)

For three-way valves mounted to an actuator with fail-safe action, the control valve has two different positions which become effective upon power supply failure:

Actuator stem extends

- Port B of the mixing valve closes upon power supply failure
- Port A of the diverting valve closes upon power supply failure

Actuator stem retracts

- Port A of the mixing valve closes upon power supply failure
- Port B of the diverting valve closes upon power supply failure

Electric actuators

The Types 5857, 5824 and 5825 Electric Actuators can be controlled by three-step signals or, in the version with positioner, with signals from 0/4 to 20 mA or 0/2 to 10 V. Various electrical accessories can be optionally installed.

Type 5825 Actuator is able to perform a fail-safe action. Refer to Table 4.

Refer to the data sheets for more details on the electric actuators:

- ▶ **T 5857:** Type 5857 Electric Actuator
- ▶ **T 5824:** Types 5824 and 5825 Electric Actuators

Electric actuators with process controllers

The electric actuator with process controller consists of a **linear actuator with an integrated digital controller**. The TROVIS 5757-7, TROVIS 5724-8, TROVIS 5725-7 and TROVIS 5725-8 Electric Actuators with Process Controller are suitable for heating and cooling applications.

TROVIS 5724-8 and TROVIS 5725-8 have two PID control modules and are ready-wired.

TROVIS 5725-7 and TROVIS 5725-8 Actuators are able to perform a fail-safe action. Refer to section Table 4.

Refer to the data sheets for more details on the electric actuators with process controller:

- ▶ **T 5757-7:** TROVIS 5757-7 Electric Actuator with Process Controller for heating and cooling applications
- ▶ **T 5725-7:** TROVIS 5725-7 Electric Actuator with Process Controller for heating and cooling applications

- ▶ **T 5724-8:** TROVIS 5724-8 and TROVIS 5725-8 Electric Actuators with Process Controller for heating and cooling applications

Pneumatic actuators

The Type 2780-1 Pneumatic Actuator uses a control signal from 0.4 to 1 bar and Type 2780-2 uses a control signal from 0.4 to 2 bar which is applied to the signal pressure connection. The pneumatic actuators require a supply pressure of at least 0.2 bar above the maximum bench range. The actuators are available for fail-safe action "actuator stem extends (FA)" or "actuator stem retracts (FE)".

The Type 2780-2 Pneumatic Actuator is suitable for integral positioner attachment.

Refer to the data sheets for more details on the pneumatic actuators:

- ▶ **T 5840:** Types 2780-1 and 2780-2 Pneumatic Actuators

Installation of the control valve

The control valves can be mounted in any position. However, the electric actuators must not be suspended downwards. Make sure that the maximum ambient temperature of 50 °C for the actuator, mounted on the valve bonnet, is not exceeded. Make sure that the inlet and outlet flows of the plant are correctly assigned to ports A, B and AB. Fig. 4 schematically illustrates a few typical applications.

Install strainers upstream of the inlets of valves mounted on actuators with fail-safe action (e.g. Type 1N or Type 1FN). If the control valve is to be insulated, the actuator and the coupling nut must not be insulated as well. Make sure that the temperature does not exceed the maximum permissible ambient temperature. If necessary, an intermediate insulating piece must be used. Do not insulate it over 25 mm.

Ordering text

Control Valve Type:

- 3226/5857, 3226/5824-..., 3226/5825-...,
 3226/5757-7, 3226/5724-8..., 3226/5725-7...,
 3226/5725-8..., 3260/2780-1, 3226/2780-2

- Valve type: mixing valve, diverting valve
- End connections:
 - male thread connection and welding ends DN ...,
 - male thread connection and threaded ends DN ...,
 - female thread G ...
- Kvs coefficient: ...
- DVGW version: yes, no

Further specifications on the electric actuator

- Control: three-step signal, positioner
- Supply voltage: ...
- Electric additional equipment: ...

Further specifications on the pneumatic actuator

- Signal pressure connection for Type 2780-1: G 1/8 ,
 1/8 NPT
- Fail-safe action: stem extends (FA), stem retracts (FE)

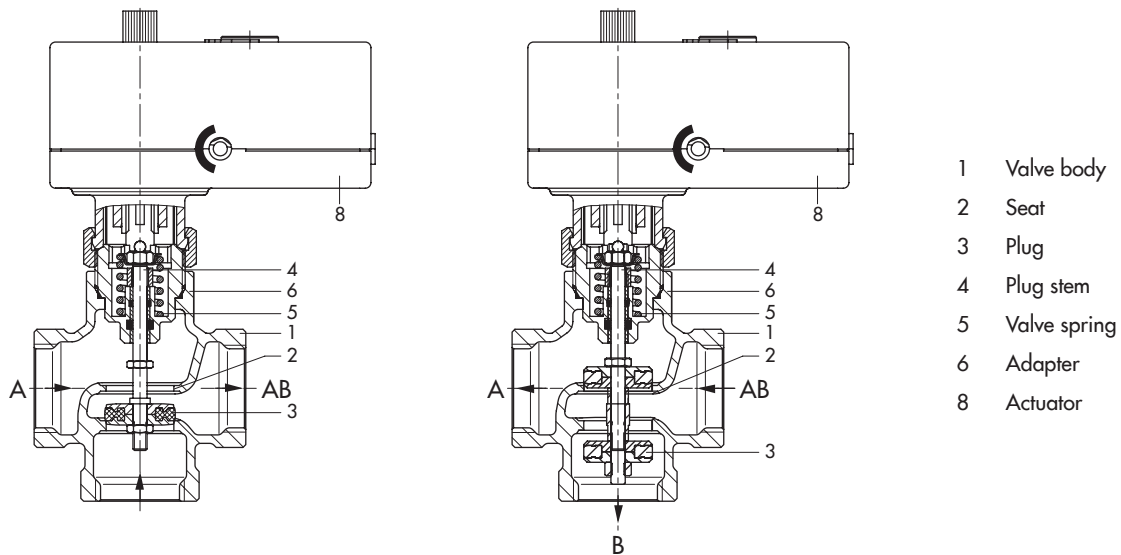
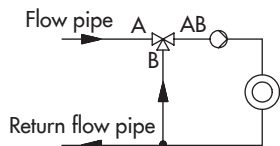
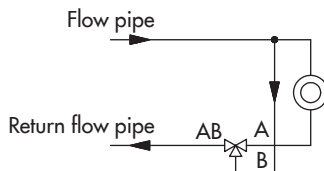

Fig. 3: Functional diagram of Type 3226/5857
left: mixing valve, right: diverting valve

Mixing valve
for mixing service



For diverting service



Diverting valve
for mixing service

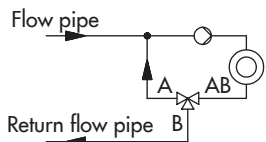

For diverting service

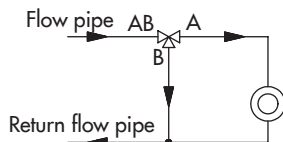

Fig. 4: Typical installations

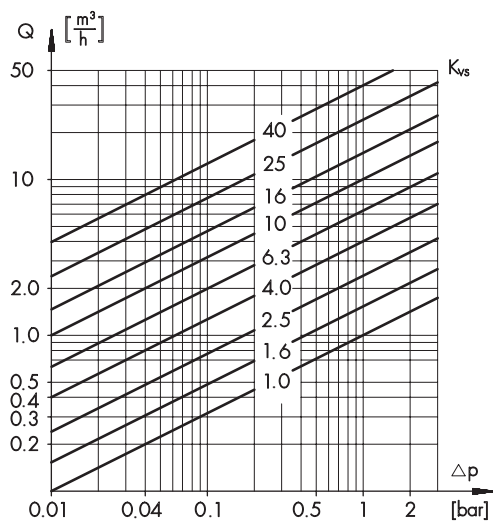



Fig. 5: Flow rate diagram for water

Table 1: Technical data · All pressures in bar (gauge)

Type 3226 Three-way Valve								
Valve size	Mixing or diverting valve with male thread connection	DN	15	20	25	32	40	50
Connection size	Mixing valve with female thread	G	½	¾	1	–	–	–
Pressure rating		PN	25					
DVGW version		PN	10					
Permissible temperature range		°C	+5 (–15) to +150 ¹⁾					
DVGW version		°C	5 to 90 °C					
Permissible differential pressure for actuators								
Type 5857, TROVIS 5757-7		bar	4	2.6	1.8	–	–	–
Type 5824, Type 5825, TROVIS 5724-8, TROVIS 5725-7, TROVIS 5725-8, Type 2780		bar	4	4	4	1.7	1.1	1.1
Rated travel		mm	6	6	6	12	12	12
Seat-plug seal	Soft seal							
Leakage class according to IEC 60534-4	Class IV (≤ 0.01 % of K_{VS} coefficient)							
Conformity								

- ¹⁾ Use intermediate insulating piece (1990-1712)
– for medium temperatures between –15 and +5 °C (actuators according to Table 4)
– in networks with constant medium temperatures >135 °C (TROVIS 5724-8, TROVIS 5725-7, TROVIS 5725-8, Type 5824 and Type 5825 Actuators)
– for liquids up to 120 °C (TROVIS 5757-7 and Type 5857 Actuators)

Table 2: Materials

Type 3226 Three-way Valve	
Valve body	CC499K (CuSn5Zn5Pb2-C)
Plug	CW617N (CuZn40Pb2zh) with EPDM
Packing	O-rings made of EPDM
Welding ends	1.0460
Threaded ends	Red brass

Table 3: Valve sizes and K_{VS} coefficients

Type 3226 Three-way Valve											
Valve size	Mixing or diverting valve with male thread connection	DN	15				20	25	32	40	50
Connection size	Mixing valve with female thread	G	½				¾	1	–	–	–
K_{VS} coefficient			1.0	1.6	2.5	4	6.3	10	16	25	40
Rated travel		mm	6	6	6	6	6	6	12	12	12

Table 4: Possible combinations

Type 3226 Three-way Valve/actuator												
Type/ TROVIS	Fail-safe action: actuator stem		Details in	Valve size DN					Thread size G			
	Extends	Retracts		15	20	25	32	40	50	½	¾	1
Electric actuators												
5857 ¹⁾	–	–	▶ T 5857	•	•	•	–	–	–	•	•	•
5824-10	–	–	▶ T 5824	•	•	•	–	–	–	•	•	•
5824-13 ²⁾	–	–		•	•	•	–	–	–	•	•	•
5825-10	•	–		•	•	•	–	–	–	•	•	•
5825-13 ²⁾	•	–		•	•	•	–	–	–	•	•	•
5825-15	–	•		•	•	•	–	–	–	•	•	•
5824-20	–	–		–	–	–	•	•	•	–	–	–
5824-23 ²⁾	–	–		–	–	–	•	•	•	–	–	–
5825-20	•	–		–	–	–	•	•	•	–	–	–
5825-23 ²⁾	•	–		–	–	–	•	•	•	–	–	–
5825-25	–	•		–	–	–	•	•	•	–	–	–
Electric actuators with process controller for heating and cooling applications												
5757-7 ¹⁾	–	–	▶ T 5757-7	•	•	•	–	–	–	•	•	•
5724-810	–	–	▶ T 5724-8	•	•	•	–	–	–	•	•	•
5724-820	–	–		–	–	–	•	•	•	–	–	–
5725-710	•	–	▶ T 5725-7	•	•	•	–	–	–	•	•	•
5725-715	–	•		•	•	•	–	–	–	•	•	•
5725-720	•	–		–	–	–	•	•	•	–	–	–
5725-725	–	•		–	–	–	•	•	•	–	–	–
5725-810	•	–	▶ T 5724-8	•	•	•	–	–	–	•	•	•
5725-820	•	–		–	–	–	•	•	•	–	–	–
Pneumatic actuators												
2780-1	•	•	▶ T 5840	•	•	•	•	•	•	•	•	•
2780-2	•	•		•	•	•	•	•	•	•	•	•

¹⁾ The valve spring in the Type 3226 Valve intended for mounting on the Types 5857 and TROVIS 5757-7 Actuators is different from that of the Type 3226 intended for mounting on other actuators. Basically, actuators with a larger nominal thrust (e.g. Type 5824) may also be combined with valves for Type 5857 and TROVIS 5757-7 Actuators, however, not vice versa.

²⁾ Version with half the transit time

Table 5: Dimensions and weights**Table 5.1:** Type 3226 Three-way Valve

Valves with male thread connection							
Valve size	DN	15	20	25	32	40	50
Length L	mm	65	70	75	100	110	130
Height H2	mm	41.5			52		
Height H3	mm	40	40	40	60	65	65
... with welding ends							
Thread size R	G	¾	1	1¼	1¾	2	2½
Pipe Ød	mm	21.3	26.8	33.7	42	48	60
Width across flats SW		30	37	46	60	65	82
Length L2	mm	210	234	244	268	294	330
Height H4	mm	112	122	124	144	157	165
Weight without actuator	kg (approx.)	3.2	3.6	4.0	6.1	7.0	8.0
... with threaded ends							
Male thread A	G	½	¾	1	1¼	1½	2
Width across flats SW		30	37	46	60	65	82
Length L3	mm	129	144	159	192	206	228
Height H5	mm	72	77	82	106	113	114
Weight without actuator	kg (approx.)	3.2	3.6	4.0	6.1	7.0	8.0
Valves with female thread							
Connection size	G	½	¾	1	-		
Length L1	mm	65	75	90	-		
Height H1	mm	40	40	40	-		
Height H2	mm	41.5			-		
AF1		27	34	46	-		
Weight without actuator	kg (approx.)	0.9	1.1	1.3	-		

Table 5.2: Electric actuators

Type	5857	5824	5825	
Weight	kg (approx.)	0.7	1.0	1.25

Table 5.3: Electric actuators with process controllers

TROVIS	5757-7	5724-8	5725-7/-8	
Weight	kg (approx.)	0.7	1.1	1.3

Table 5.4: Pneumatic actuators

Type	2780-1	2780-2	
Weight	kg (approx.)	2	3.2

Type 3226 Three-way Valve with male thread connection and welding ends

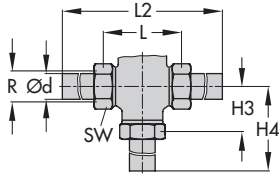

Type 3226 Three-way Valve with male thread connection and threaded ends

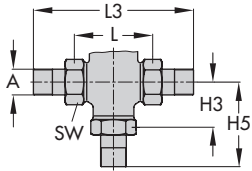

Type 3226 Three-way Valve with female thread

Electric control valves

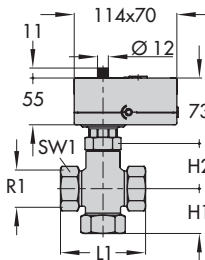

Type 3226/5857: DN 15 to 25
 Type 3226/5757-7: DN 15 to 25

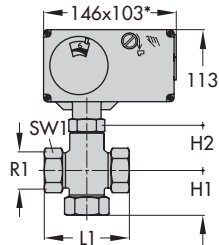

Type 3226/5824: DN 15 to 50
 Type 3226/5825: DN 15 to 50
 Type 3226/5724-8: DN 15 to 50
 Type 3226/5725-7: DN 15 to 50
 Type 3226/5725-8: DN 15 to 50

* Dimensions for actuators
 Types 5824-x3/5825-x3:
 146x136

Pneumatic Control Valves

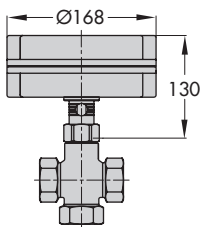

Type 3226/2780-1: DN 15 to 50

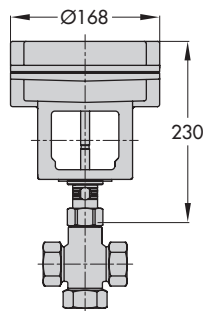

Type 3226/2780-2: DN 15 to 50

